

**Agilent E4991A RF Impedance/Material Analyzer**

# **Programming Manual**

**Third Edition**



**Agilent Part No. E4991-90042**

**March 2003**

Printed in Japan

---

## Notices

The information contained in this document is subject to change without notice.

This document contains proprietary information that is protected by copyright. All rights are reserved. No part of this document may be photocopied, reproduced, or translated to another language without the prior written consent of Agilent Technologies.

Agilent Technologies Japan, Ltd.

Component Test PGU-Kobe

1-3-2, Murotani, Nishi-ku, Kobe-shi, Hyogo, 651-2241 Japan

Ms, Microsoft, Windows, Visual Basic, Excel, and Word are U.S. registered trademarks of Microsoft Corporation.

© Copyright Agilent Technologies Japan, Ltd. 2001, 2003

---

## Manual Printing History

The manual's printing date and part number indicate its current edition. The printing date changes when a new edition is printed (minor corrections and updates that are incorporated at reprint do not cause the date to change). The manual part number changes when extensive technical changes are incorporated.

March 2001	Preliminary (part number: E4991-90002)
April 2001	Preliminary (part number: E4991-90012)
July 2001	First Edition (part number: E4991-90022)
September 2001	Second Edition (part number: E4991-90032)
March 2003	Third Edition (part number: E4991-90042)

---

## Typeface Conventions

**sample (bold)**

Boldface type is used for emphasis.

*sample (Italic)*

Italic type is used for emphasized phrases and titles of manuals in English.

[**sample**]

Indicates the key on the front panel labeled “**sample**”. It also may refer to the label on the button.

**sample**

Indicates the menu, button, or box labeled “**sample**”, which can be clicked to carry out the

settings and choice.  
Menu indicates menu bar, pull-down menu, and short-cut menu.  
Button refers to the buttons in dialog box and setup toolbar.  
Box indicates the spin box, drop-down list box, text box, and list box.

**SAMPLE**

Indicates the block or toolbar labeled “**SAMPLE**”.  
Block indicates the key group on the front panel.  
Tool bar indicates the setup toolbar (the group of buttons and boxes on the setup screen displayed in the right row).

**s1 - s2 - s3 - s4**

Indicates a series of operations using the menu or key labeled “**s1**,” “**s2**” and the button or box in the setup toolbar labeled “**s3**,” “**s4**”.

---

## Sample Program Disk

Sample program disks (Agilent Part Number E4991-180x0) are furnished with this manual. The disk contains the sample programs used in this manual.

The customer shall have the personal, non-transferable rights to use, copy, or modify SAMPLE PROGRAMS in this manual for the Customer’s internal operations. The customer shall use the SAMPLE PROGRAMS solely and exclusively for their own purposes and shall not license, lease, market, or distribute the SAMPLE PROGRAMS or modification of any part thereof.

Agilent Technologies shall not be liable for the quality, performance, or behavior of the SAMPLE PROGRAMS. Agilent Technologies especially disclaims any responsibility for the operation of the SAMPLE PROGRAMS to be uninterrupted or error-free. The SAMPLE PROGRAMS are provided AS IS.

AGILENT TECHNOLOGIES DISCLAIMS ANY IMPLIED WARRANTY OF MERCHANTABILITY AND FITNESS FOR A PARTICULAR PURPOSE.

Agilent Technologies shall not be liable for any infringement of any patent, trademark, copyright, or other proprietary right by the SAMPLE PROGRAMS or their use. Agilent Technologies does not warrant that the SAMPLE PROGRAMS are free from infringements of such rights of third parties. However, Agilent Technologies will not knowingly infringe or deliver software that infringes the patent, trademark, copyright, or other proprietary right of a third party.

---

## E4991A Documentation Map

The following manuals are available for the Agilent E4991A.

- ***Operational Manual (Part Number: E4991-900x0, attached to optional ABA)***

This manual describes most of the basic information necessary to use the E4991A. It provides a function overview, detailed operation procedure for each function (from preparation for measurement to analysis of measurement results), measurement examples, specifications, and supplemental information. For programming guidance on performing automatic measurement with the E4991A, please see the *Programming Manual*.

- ***Installation and Quick Start Guide (Part Number: E4991-900x1, attached to optional ABA)***

This manual describes installation after it is delivered and the basic operation procedures for applications and analysis. Refer to this manual when you use the E4991A for the first time.

- ***Programming Manual (Part Number: E4991-900x2, attached to optional ABA)***

This manual provides programming information for performing automatic measurement with the E4991A. It includes an outline of remote control, procedures for detecting measurement start (trigger) and end (sweep end), application programming examples, command reference, and related information.

---

### NOTE

The number position shown by “x” in the part numbers above indicates the edition number. This convention is applied to each manual, CD-ROM (for manuals), and sample programs disk issued. Here, “0” indicates the initial edition, and each time a revision is made this number is incremented by 1. The latest edition allows the customer to specify Option ABA (English version).

---



<b>1. To Make Effective Use of This Manual</b>	
Contents of this manual	20
How to use this manual	23
Selecting the structure of remote control system	23
Sample programs	24
<b>2. Outline of Remote Control</b>	
Outline of GPIB remote control system	26
System structure	26
Sending GPIB command messages	29
Remote control using E4991A macros	32
System structure	32
How to operate macros	33
Sending command messages	34
Remote mode	34
Remote control using remote user interface function and application software	35
System structure	35
How to use the application software	36
Sending command messages	37
Remote mode	37
<b>3. Setting Measurement Conditions</b>	
Set Measurement Parameter	40
Measurement Mode	40
Display Trace	40
Parameters for Scalar Trace	41
Phase Display for Scalar Trace	42
Parameters for Complex Trace	43
Set Sweep Conditions	44
Select Sweep Parameter	44
Set Number of Measurement Points	44
Set Sweep Direction	44
Set Sweep Range	45
Set Sweep Time	47
Set Delay Time	47
Set Frequency Span (only segment sweep)	47
Set Measurement Source	48
Set Source	48
Set DC Bias (DC Bias Function)	49
Set Averaging	50
Sweep Averaging	50
Point Averaging	50
Set Display Scale	51
Select Trace for Which Scale Is Set	51
Automatic Scale Adjustment	51
Manual Setting of Scale	51
Example program for setting the measuring conditions	54
Example program using HTBasic	55

---

# Contents

Example program using macro (E4991A VBA) . . . . .	59
Combination of Several Sweep Conditions (Segment Sweep) . . . . .	64
Create/Edit Segment Sweep Table . . . . .	64
Example program for setting the segment sweep conditions . . . . .	66
Example program using HTBasic . . . . .	66
Example program using macro (E4991A VBA) . . . . .	70
<b>4. Preparation for Accurate Measurement</b>	
Calibration . . . . .	74
Define Calibration Kit . . . . .	74
Define Load Standard Value Used for Measurement of Dielectric Material . . . . .	75
Select Calibration Data Measurement Points . . . . .	75
Measure Calibration Data . . . . .	76
Calibration Data Array/Calibration Coefficient Array . . . . .	77
Example program for execution of calibration . . . . .	78
Example program for calibration coefficient transfer . . . . .	87
Electrical Length Compensation . . . . .	91
Test Fixture . . . . .	91
Add Offset Delay Time (Port Extension Compensation) . . . . .	92
Fixture Compensation . . . . .	93
Define Fixture Compensation Kit . . . . .	93
Select Fixture Compensation Data Measurement Points . . . . .	94
Measure Fixture Compensation Data . . . . .	95
Fixture Compensation Data Array/Fixture Compensation Coefficient Array . . . . .	96
Example program for execution of fixture compensation . . . . .	97
<b>5. Measurement Start and Detection of Measurement End</b>	
Measurement Trigger (Measurement Start) . . . . .	108
Trigger System . . . . .	108
Trigger Measurement . . . . .	111
Waiting for Measurement End (Detection of Sweep End) . . . . .	112
Using the Status Register . . . . .	112
Adding Wait Time . . . . .	113
Example Programs for Detecting Measurement End . . . . .	114
Example program using HTBasic (SRQ) . . . . .	114
Example program using macro (E4991A VBA) . . . . .	116
<b>6. Read and Write Measurement Data</b>	
Data Transfer Format . . . . .	120
ASCII Format . . . . .	120
IEEE 32-Bit Floating Point Format . . . . .	121
IEEE 64-Bit Floating Point Format . . . . .	122
Specify Byte Order (Binary Transfer) . . . . .	122
Internal Data Flow . . . . .	123
Data Processing Flow . . . . .	123
Internal Data Arrays . . . . .	123
Timing for read/write . . . . .	128
Example Programs for Reading Internal Data Arrays . . . . .	129

Reading the data trace array (ASCII format) . . . . .	129
Reading the dc bias level monitor array . . . . .	133
<b>7. Measurement Result Processing</b>	
Using Marker Function . . . . .	140
Markers . . . . .	140
Moving Markers and Reading at Marker Positions . . . . .	141
Setting $\Delta$ Mode . . . . .	142
Entering Marker Values as E4991A Setting . . . . .	143
Marker Search Function . . . . .	144
Limit Test Function . . . . .	147
Statistical Analysis Function . . . . .	149
Example Programs for Marker Search Function . . . . .	150
Example Programs for Marker Limit Test Function . . . . .	159
Equivalent Circuit Analysis . . . . .	167
Selecting an Equivalent Circuit Model . . . . .	167
Performing Equivalent Circuit Analysis . . . . .	168
Simulating Frequency Characteristics . . . . .	168
Example Programs for Equivalent Circuit Analysis . . . . .	169
<b>8. Save and Recall Files</b>	
Saving and Recalling Files . . . . .	176
Current Folder . . . . .	176
Saving Files . . . . .	177
Recalling Files . . . . .	178
Automatic Recall of State File . . . . .	178
Folder and File Manipulation . . . . .	179
Folders . . . . .	179
Files . . . . .	179
Example Programs for Saving/Recalling a File . . . . .	180
Example program using HTBasic . . . . .	180
Example program using macro (E4991A VBA) . . . . .	187
<b>9. Using Printer</b>	
Printing out to a Printer Connected to E4991A . . . . .	196
Selecting Print Contents . . . . .	196
Selecting Color . . . . .	196
Performing Printout . . . . .	196
Cancelling Printing . . . . .	196
<b>10. Setting the Display</b>	
Setting the Display . . . . .	198
GPIB Commands for Entire Screen (windows) . . . . .	198
GPIB Commands for Traces . . . . .	198
When Data Trace Is Refreshed . . . . .	200
Refresh for Each Sweep . . . . .	200
Refresh for Each Measurement Point . . . . .	200
Refresh Periodically . . . . .	200

---

# Contents

<b>11. Error Handling</b>	
Using the Error Queue . . . . .	202
Using Status Report Mechanism . . . . .	203
Example Program for Error Handling . . . . .	204
Using HTBasic . . . . .	204
Using the macro (E4991A VBA) . . . . .	206
<b>12. Shutting Down the Instrument</b>	
Shutdown Procedure . . . . .	210
<b>13. Use of Macros</b>	
Overview of Macros . . . . .	212
Macro Function Overview . . . . .	213
Starting Up and Closing Visual Basic Editor . . . . .	214
Starting up Visual Basic Editor . . . . .	214
Quitting Visual Basic Editor . . . . .	214
Displaying the E4991A measurement screen . . . . .	214
Making/Editing Macros . . . . .	215
Elements of Visual Basic Editor . . . . .	215
Describing macros . . . . .	226
E4991A Library . . . . .	228
Macro recording . . . . .	228
Debugging macros . . . . .	229
Executing and Terminating Macros . . . . .	230
Executing macros . . . . .	230
Executing macros by GPIB commands . . . . .	231
Terminating macros . . . . .	231
Saving/Loading Macros . . . . .	232
Saving macros . . . . .	232
Loading macros . . . . .	233
Using E4991A VBA Help . . . . .	234
Displaying the E4991A VBA help screen . . . . .	234
Displaying topics of E4991A VBA . . . . .	235
Referring to contents of keywords . . . . .	235
<b>14. Outline of Programming Using COM</b>	
Outline of E4991A COM . . . . .	238
E4991A COM Object . . . . .	238
Limitations on using the E4991A COM object . . . . .	239
Comparison of COM objects and GPIB commands . . . . .	239
E4991A COM Object Model . . . . .	242
Application Object . . . . .	242
SCPI Object . . . . .	243
E4991A Library . . . . .	244
Where to install the E4991A library . . . . .	244
<b>15. Controlling Peripherals</b>	
Overview . . . . .	246

1. Placing E4991A in system control mode .....	246
2. Importing definition files .....	246
Programming with VISA .....	247
STEP 1. Starting up VISA system .....	248
STEP 2. Connection .....	248
STEP 3. Communication .....	249
STEP 4. Disconnection .....	250
Application program using DC power supply (Agilent E3631A) .....	251
<b>16. Application Programs</b>	
Basic Measurement .....	254
HTBasic example program .....	254
Macro (E4991A VBA) Example Program .....	264
<b>17. GPIB Command Reference</b>	
Conventions .....	276
Format .....	276
Description .....	276
Parameters .....	277
Query response .....	278
Related command(s) .....	278
Front Panel Equivalents .....	278
IEEE subsystem .....	279
*CLS .....	279
*ESE .....	280
*ESR? .....	280
*IDN? .....	281
*OPC .....	281
*OPC? .....	281
*OPT? .....	282
*RST .....	282
*SRE .....	283
*STB? .....	283
*TRG .....	284
*TST? .....	284
*WAI .....	284
E4991A GPIB command .....	286
ABOR .....	286
AVER .....	287
AVER:COUN .....	288
CALC:AVER .....	289
CALC:AVER:CLE .....	289
CALC:AVER:COUN .....	290
CALC:BMON .....	291
CALC:DATA:MON? .....	292
CALC{1-5}:DATA? .....	293
CALC{1-5}:DATA:EPAR .....	294
CALC{1-5}:EPAR .....	295

---

## Contents

CALC{1-5}:EPAR:CIRC . . . . .	296
CALC{1-5}:EPAR:SIM . . . . .	297
CALC{1-5}:FORM . . . . .	298
CALC:FORM:PAR:DIE . . . . .	300
CALC{1-3}:FORM:PAR:EPH . . . . .	301
CALC:FORM:PAR:MAG . . . . .	302
CALC{1-5}:FORM:UNIT:ANGL . . . . .	303
CALC{1-5}:MARK{1-8} . . . . .	304
CALC{1-5}:MARK{1-8}:ACT . . . . .	305
CALC{1-5}:MARK:AOFF . . . . .	305
CALC{1-5}:MARK:APE:SET . . . . .	306
CALC{1-5}:MARK:APE:EXC:X . . . . .	307
CALC{1-5}:MARK:APE:EXC:Y . . . . .	308
CALC:MARK:COUP . . . . .	309
CALC{1-5}:MARK:DISC . . . . .	309
CALC{4-5}:MARK:FORM . . . . .	310
CALC{1-5}:MARK:FUNC . . . . .	311
CALC{1-5}:MARK:FUNC:DOM . . . . .	312
CALC{1-5}:MARK{1-8}:FUNC:DOM:LIM . . . . .	313
CALC{1-5}:MARK:FUNC:DOM:LIM:ALL . . . . .	314
CALC{1-5}:MARK:FUNC:DOM:LIM:ALL:RES? . . . . .	315
CALC{1-5}:MARK{1-8}:FUNC:DOM:LIM:LOW . . . . .	316
CALC{1-5}:MARK{1-8}:FUNC:DOM:LIM:RES? . . . . .	317
CALC{1-5}:MARK{1-8}:FUNC:DOM:LIM:UP . . . . .	318
CALC{1-5}:MARK:FUNC:DOM:SPAN . . . . .	319
CALC{1-5}:MARK:FUNC:DOM:STAR . . . . .	320
CALC{1-5}:MARK:FUNC:DOM:STOP . . . . .	320
CALC{1-5}:MARK:FUNC:EXEC . . . . .	321
CALC{1-5}:MARK:FUNC:EXEC:LEFT . . . . .	322
CALC{1-5}:MARK:FUNC:EXEC:NEXT . . . . .	322
CALC{1-5}:MARK:FUNC:EXEC:RIGH . . . . .	323
CALC{1-5}:MARK:FUNC:TARG . . . . .	324
CALC{1-5}:MARK:FUNC:TRAC . . . . .	325
CALC{1-5}:MARK:LIST . . . . .	326
CALC{1-5}:MARK:ON . . . . .	327
CALC{1-5}:MARK:REF . . . . .	328
CALC{1-5}:MARK:REF:ACT . . . . .	329
CALC{1-5}:MARK:REF:FUNC:DOM:LIM . . . . .	329
CALC{1-5}:MARK:REF:FUNC:DOM:LIM:LOW . . . . .	330
CALC{1-5}:MARK:REF:FUNC:DOM:LIM:RES? . . . . .	331
CALC{1-5}:MARK:REF:FUNC:DOM:LIM:UP . . . . .	332
CALC{1-5}:MARK:REF:TYPE . . . . .	333
CALC{1-5}:MARK:REF:X . . . . .	334
CALC{1-5}:MARK:REF:Y . . . . .	335
CALC{1-5}:MARK:SET . . . . .	336
CALC{1-5}:MARK:UNIT . . . . .	337
CALC{1-5}:MARK{1-8}:X . . . . .	338
CALC{1-5}:MARK{1-8}:Y? . . . . .	339
CALC{1-5}:MATH:FUNC . . . . .	340

CALC{1-5}:MATH:MEM	341
CALC{1-3}:MATH:OFFS	342
CALC{1-5}:MST	343
CALC{1-5}:MST:DATA?	344
DATA:CAD{1-8}?	345
DATA:CCO{1-6}	346
DATA:CMD{1-2}?	347
DATA:CMP{1-3}	348
DATA:RAW?	349
DATA:SEGM{1-16}:CAD{1-8}?	350
DATA:SEGM{1-16}:CCO{1-6}	351
DATA:SEGM{1-16}:CMD{1-2}?	352
DATA:SEGM{1-16}:CMP{1-3}	353
DISP:BACK	354
DISP:ENAB	354
DISP:FORM	355
DISP:TEXT	355
DISP:TEXT{1-3}:SET	356
DISP:TRAC{1-5}	356
DISP:TRAC{1-5}:GRAT:FORM	357
DISP:TRAC{1-3}:REF	358
DISP:TRAC{1-5}:SEL	358
DISP:TRAC{1-5}:TEXT	359
DISP:TRAC{1-5}:TEXT:PAGE	359
DISP:TRAC{1-5}:TITL	360
DISP:TRAC{1-5}:TITL:DATA	361
DISP:TRAC{4-5}:X:RLEV	362
DISP:TRAC{1-5}:X:SPAC	363
DISP:TRAC{1-5}:Y:AUTO	364
DISP:TRAC:Y:AUTO:ALL	364
DISP:TRAC{1-3}:Y:BOTT	365
DISP:TRAC{1-5}:Y:FOR	366
DISP:TRAC{1-5}:Y:FULL	367
DISP:TRAC{1-5}:Y:PDIV	368
DISP:TRAC{1-5}:Y:RLEV	369
DISP:TRAC{1-3}:Y:RPOS	370
DISP:TRAC{1-3}:Y:SPAC	371
DISP:TRAC{1-3}:Y:TOP	372
FORM:BORD	373
FORM:DATA	374
FREQ	375
FREQ:CENT	376
FREQ:SPAN	377
FREQ:SPAN:FULL	377
FREQ:STAR	378
FREQ:STOP	379
HCOP	380
HCOP:ABOR	380
HCOP:CONT	380

---

## Contents

HCOP:IMAG	381
INIT	382
INIT:CONT	382
MMEM:CAT?	383
MMEM:CDIR	383
MMEM:COPY	384
MMEM:DEL	384
MMEM:LOAD	385
MMEM:LOAD:MACR	385
MMEM:LOAD:TRAC	386
MMEM:MDIR	386
MMEM:MOVE	387
MMEM:RDIR	388
MMEM:STOR	388
MMEM:STOR:CITI{1-3}	389
MMEM:STOR:GRAP	389
MMEM:STOR:GRAP:BMP	390
MMEM:STOR:MACR	390
MMEM:STOR:TRAC	391
MMEM:STOR:TRAC:ASC	391
MMEM:STOR:TRAC:SEL{1-4}	392
MODE	393
PROG:CAT?	394
PROG:NAME	394
PROG:STAT	395
PROG:WAIT	395
SEGM{1-16}:AVER:COUN	396
SEGM:COUN	397
SEGM{1-16}:CURR	398
SEGM:CURR:OFFS:STAT	399
SEGM{1-16}:CURR:LIM	400
SEGM{1-16}:CURR:OFFS	401
SEGM:CURR:STAT	402
SEGM{1-16}:DATA	403
SEGM:DATA:ALL	405
SEGM:DEL:ALL	406
SEGM{1-16}:FREQ:CENT	407
SEGM{1-16}:FREQ:SPAN	408
SEGM{1-16}:FREQ:STAR	409
SEGM{1-16}:FREQ:STOP	410
SEGM{1-16}:POW	411
SEGM:POW:STAT	412
SEGM{1-16}:SWE:POIN	413
SEGM{1-16}:VOLT	414
SEGM{1-16}:VOLT:LIM	415
SEGM{1-16}:VOLT:OFFS	416
SEGM:VOLT:OFFS:STAT	417
SEGM:VOLT:STAT	418
SENS:CORR1	419



SENS:CORR1:CKIT	420
SENS:CORR1:CKIT:LIST	421
SENS:CORR1:CKIT:STAN1:C	422
SENS:CORR1:CKIT:STAN1:G	423
SENS:CORR1:CKIT:STAN1:LIST:B	424
SENS:CORR1:CKIT:STAN1:LIST:G	425
SENS:CORR1:CKIT:STAN2:L	426
SENS:CORR1:CKIT:STAN2:LIST:R	427
SENS:CORR1:CKIT:STAN2:LIST:X	428
SENS:CORR1:CKIT:STAN2:R	429
SENS:CORR1:CKIT:STAN3:L	430
SENS:CORR1:CKIT:STAN3:LIST:R	431
SENS:CORR1:CKIT:STAN3:LIST:X	432
SENS:CORR1:CKIT:STAN3:R	433
SENS:CORR1:CKIT:STAN7:PLF	434
SENS:CORR1:CKIT:STAN7:PRE	435
SENS:CORR1:CKIT:STAN7:THIC	436
SENS:CORR1:COLL	437
SENS:CORR1:COLL:FPO	438
SENS:CORR1:COLL:SAVE	439
SENS:CORR2:CKIT:LIST	440
SENS:CORR2:CKIT:STAN1:C	441
SENS:CORR2:CKIT:STAN1:G	442
SENS:CORR2:CKIT:STAN1:LIST:B	443
SENS:CORR2:CKIT:STAN1:LIST:G	444
SENS:CORR2:CKIT:STAN2:L	445
SENS:CORR2:CKIT:STAN2:LIST:R	446
SENS:CORR2:CKIT:STAN2:LIST:X	447
SENS:CORR2:CKIT:STAN2:R	448
SENS:CORR2:COLL	449
SENS:CORR2:COLL:FPO	450
SENS:CORR2:COLL:OPEN	451
SENS:CORR2:COLL:SAVE	451
SENS:CORR2:COLL:SHOR	452
SENS:CORR2:EDEL:TIME	453
SENS:CORR2:FIXT	454
SENS:CORR2:FIXT:EDEL:MODE:DIST?	455
SENS:CORR2:FIXT:EDEL:USER:DIST	456
SOUR:CURR	457
SOUR:CURR:CENT	458
SOUR:CURR:LIM:OFFS	459
SOUR:CURR:MODE	460
SOUR:CURR:OFFS	461
SOUR:CURR:OFFS:CENT	462
SOUR:CURR:OFFS:SPAN	463
SOUR:CURR:OFFS:STAR	464
SOUR:CURR:OFFS:STAT	465
SOUR:CURR:OFFS:STOP	466
SOUR:CURR:SPAN	467

---

## Contents

SOUR:CURR:STAR	468
SOUR:CURR:STOP	469
SOUR:POW	470
SOUR:POW:CENT	471
SOUR:POW:MODE	472
SOUR:POW:SPAN	473
SOUR:POW:STAR	474
SOUR:POW:STOP	475
SOUR:VOLT	476
SOUR:VOLT:CENT	477
SOUR:VOLT:LIM:OFFS	478
SOUR:VOLT:MODE	479
SOUR:VOLT:OFFS	480
SOUR:VOLT:OFFS:CENT	481
SOUR:VOLT:OFFS:SPAN	482
SOUR:VOLT:OFFS:STAR	483
SOUR:VOLT:OFFS:STAT	484
SOUR:VOLT:OFFS:STOP	485
SOUR:VOLT:SPAN	486
SOUR:VOLT:STAR	487
SOUR:VOLT:STOP	488
STAT:OPER?	489
STAT:OPER:COND?	489
STAT:OPER:ENAB	490
STAT:OPER:NTR	491
STAT:OPER:PTR	492
STAT:PRES	493
STAT:QUES?	493
STAT:QUES:COND?	493
STAT:QUES:ENAB	494
STAT:QUES:HARD?	495
STAT:QUES:HARD:COND?	495
STAT:QUES:HARD:ENAB	496
STAT:QUES:HARD:NTR	497
STAT:QUES:HARD:PTR	498
STAT:QUES:LIM?	499
STAT:QUES:LIM:COND?	499
STAT:QUES:LIM:ENAB	500
STAT:QUES:LIM:NTR	501
STAT:QUES:LIM:PTR	502
STAT:QUES:NTR	503
STAT:QUES:PTR	504
STAT:QUES:SEAR?	504
STAT:QUES:SEAR:COND?	505
STAT:QUES:SEAR:ENAB	505
STAT:QUES:SEAR:NTR	506
STAT:QUES:SEAR:PTR	507
SWE:DIR	508
SWE:DWEL1	508

SWE:DWEL2	509
SWE:DWEL3	510
SWE:POIN	511
SWE:STIM{1-4}?	512
SWE:TIME	513
SWE:TIME:AUTO	514
SWE:TYPE	515
SYST:BEEP	516
SYST:BEEP:STAT	516
SYST:DATE	517
SYST:ERR?	517
SYST:ERR:COUN?	518
SYST:EXTR?	518
SYST:IND:POIN:SET	519
SYST:IND:SWE:SET	519
SYST:IND:TIME	520
SYST:IND:TIME:SET	521
SYST:KLOC	522
SYST:KLOC:KBD	522
SYST:KLOC:MOUS.	523
SYST:POFF	523
SYST:PRES	523
SYST:TIME	524
SYST:VERS?	524
TRIG	525
TRIG:EVEN	525
TRIG:SLOP	526
TRIG:SOUR	526
<b>18. COM Interface Reference</b>	
Conventions of COM Interface	528
Explanation	528
VB Syntax	528
Parameter	528
Response	529
Examples	529
Application object	530
Name property	530
VBVersion property	530
Connection property	531
SingleMeasure method	532
CalMeasure method	533
CompenMeasure method	534
GetTextData method	535
GetScreenImage method	535
WaitForEvent method	536
SweepEnd event	537
SweepStart event	538
CompleteSweepAveraging event	538

---

# Contents

Unlocked event . . . . .	539
DcBiasOverload event . . . . .	539
RfOverload event . . . . .	540
SCPI object . . . . .	541
Name property . . . . .	541
Enter method . . . . .	542
Output method . . . . .	543
Query method . . . . .	543
How to read array data . . . . .	544
Option parameters offered in Enter method . . . . .	544
Not specifying option parameter . . . . .	544
Specifying option parameters . . . . .	546
<b>A. Manual Changes</b>	
Manual Changes . . . . .	550
<b>B. GPIB Status Report System</b>	
General Model of Status Registers . . . . .	552
Event Registers . . . . .	553
Enable Registers . . . . .	553
Status Byte Register . . . . .	554
Transition Filter and Condition Register . . . . .	555
Status Register Structure . . . . .	556
<b>C. GPIB Command List By Function</b>	
GPIB Command List By Function . . . . .	566
<b>D. Table of corresponding 4291B vs. E4991A GPIB commands</b>	
Table of Corresponding GPIB Commands . . . . .	580
<b>E. Complex Operation Programs</b>	
Complex Operation Programs . . . . .	600
Sample Implementation in Visual Basic . . . . .	600
Sample Implementation in HTBasic . . . . .	601
<b>F. List of Responses to Measurement Failure</b>	
Behavior under Abnormal Measurement Conditions . . . . .	604
<b>G. Messages</b>	
Order of Error Number . . . . .	606
Messages indicating the internal status of the equipment . . . . .	618
Messages indicating the measurement failure . . . . .	618
Messages indicating the results of processing (elapsing) . . . . .	619





---

# **1 To Make Effective Use of This Manual**

This chapter describes the contents of this programming manual and how to use it.

## Contents of this manual

This is the programming manual of the E4991A RF Impedance/Material Analyzer. The contents of each chapter in this manual are as follows.

### Chapter 1, “To Make Effective Use of This Manual”

This chapter describes the contents of this programming manual and how to use it.

### Chapter 2, “Outline of Remote Control”

This chapter explains the system structures, required equipment, and set up methods needed to structure the remote control system of the E4991A.

### Chapter 3, “Setting Measurement Conditions”

This chapter explains how to set the measurement conditions of the Agilent E4991A.

### Chapter 4, “Preparation for Accurate Measurement”

This chapter explains how to perform calibration as well as electrical length and fixture compensation for the Agilent E4991A.

### Chapter 5, “Measurement Start and Detection of Measurement End”

This chapter explains how to prepare a trigger for starting measurement and detecting the end of measurement with the Agilent E4991A.

### Chapter 6, “Read and Write Measurement Data”

This chapter explains how to read and write Agilent E4991A measurement data.

### Chapter 7, “Measurement Result Processing”

This chapter explains how to process measurement results by using the Agilent E4991A’s marker function and equivalent circuit analysis function.

### Chapter 8, “Save and Recall Files”

This chapter explains how to save the Agilent E4991A’s measurement condition settings or measurement results to a file and how to later recall them from the file.

### Chapter 9, “Using Printer”

This chapter explains how to use a printer connected to the Agilent E4991A to print out measurement results and other information from the instrument.

### Chapter 10, “Setting the Display”

This chapter explains how to set the display screen of the Agilent E4991A.

### Chapter 11, “Error Handling”

This chapter describes how the Agilent E4991A handles errors in program execution.

### Chapter 12, “Shutting Down the Instrument”

This chapter explains how to properly shut down the Agilent E4991A.



#### Chapter 13, “Use of Macros”

This chapter explains how to use the macro function of the Agilent E4991A to create macro programs with the Visual Basic editor. Information is also given on how to execute produced macros.

#### Chapter 14, “Outline of Programming Using COM”

This chapter gives the required information for programming with the COM interface of the Agilent E4991A. For more basic information on the COM interface, refer to Chapter 18, “COM Interface Reference.”

#### Chapter 15, “Controlling Peripherals”

This chapter explains how to control peripherals connected to the Agilent E4991A by using the software (VISA) installed in the instrument.

#### Chapter 16, “Application Programs”

This chapter gives measurement examples (sample programs) using the HTBasic program and the instrument’s macro program (E4991A VBA).

#### Chapter 17, “GPIB Command Reference”

This chapter provides the GPIB command reference of the Agilent E4991A. The command references are written in abbreviated form and listed in alphabetic order.

#### Chapter 18, “COM Interface Reference”

This chapter gives COM interface references of the Agilent E4991A classified according to object.

#### Appendix A, “Manual Changes”

This appendix contains the information required to adapt this manual to versions or configurations of the Agilent E4991A manufactured earlier than the current printing date of this manual. The information contained elsewhere in this manual applies directly to E4991A units bearing the serial number printed on this manual’s title page.

#### Appendix B, “GPIB Status Report System”

This appendix describes the status report system in the Agilent E4991A GPIB system.

#### Appendix C, “GPIB Command List By Function”

This appendix lists the Agilent E4991A GPIB commands according to function.

#### Appendix D, “Table of corresponding 4291B vs. E4991A GPIB commands”

This appendix lists each Agilent E4991A GPIB command along with its corresponding Agilent 4291B GPIB command. Note that the simple commands prepared for the 4291B do not have equivalent E4991A commands.

#### Appendix E, “Complex Operation Programs”

This appendix shows sample programs for implementing complex operations in Visual Basic and HTBasic.

To Make Effective Use of This Manual  
**Contents of this manual**

Appendix F, “List of Responses to Measurement Failure”

This appendix lists the Agilent E4991A’s responses to various types of measurement failure.

Appendix G, “Messages”

The Agilent E4991A provides error messages as well as messages that indicate the internal operating status of the equipment. This appendix describes such messages in order of error number. To search for E4991A error messages in alphabetical order, please refer to the Operation Manual.

---

## How to use this manual

When writing programs, it is not necessarily required to use all the information in this manual. Basically, the structure of remote control system that the user decides will determine required equipment, programming language that is necessary to understand, and command set to control the E4991A.

### Selecting the structure of remote control system

First, select the remote control system to suit the purpose from the following remote control system structures, and read this manual according to the contents written there.

1. Manual operation

Operating the E4991A through the front panel of the E4991A or keyboard/mouse. This doesn't suit the measurement of complex setting combination while it doesn't require the preparation of external controller separately or the knowledge of programming to control the E4991A. Refer to the operation manual for how to operate E4991A through the front panel or keyboard/mouse.

2. Manual operation using remote user interface function

If remote user interface function is used, it becomes possible to operate the E4991A from Personal Computer by providing the environment of the E4991A user interface (keyboard/mouse connected to the E4991A) for the Personal Computer connected to the E4991A on LAN. Refer to the operation manual for the set-up and usage of remote user interface function.

3. GPIB remote control system

The E4991A can be controlled from external controller (for example, computers like a Personal Computer, Work Station, etc.) through GPIB interface. The outline of the system is explained in "Outline of GPIB remote control system" on page 26.

4. Remote control using macros in the E4991A

The E4991A and peripheral equipment can be controlled by using the macros (Visual Basic for Application) which is installed in the E4991A. The outline of the system is explained in "Remote control using E4991A macros" on page 32.

5. Remote control using remote user interface function and application software.

The E4991A can be controlled from the Personal Computer that is connected to the E4991A by the remote user interface function, using application software (Microsoft Visual Basic, and etc.). The outline of the system is explained in "Remote control using remote user interface function and application software" on page 35.

To Make Effective Use of This Manual  
**How to use this manual**

**Sample programs**

The sample program disk (Agilent Parts No. E4991-180x0) and CD-ROM (Agilent Parts No. E4991-905x0) contain HTBasic sample programs and E4991A VBA sample programs shown in this manual. These sample program disks are DOS formatted.

**How to load the sample program**

To use the sample program on HTBasic, load it by GET command on HTBasic. The following is an example of loading a sample program, "setup.htb".

```
GET "setup.htb"
```

To use the sample program on the E4991A VBA which file extension is \*.lcr, load the macro program after the following front panel operation from the E4991A.

**Utility - Load Program...**

Or, to use the sample program on the E4991A VBA which file extension is \*.bas or \*.cls, import the macro program from the Visual Basic Editor.

---

## 2

# Outline of Remote Control

This chapter explains the system structures, required equipment, and set up methods needed to structure the remote control system of the E4991A.

## Outline of GPIB remote control system

This section explains the system structures and required equipment for sending GPIB command messages. In Chapter 17, you can also find more on the GPIB commands used to control the E4991A from an external computer through the GPIB interface.

### System structure

Connect the E4991A to an external computer and peripheral equipment with a GPIB cable. Figure 2-1 outlines the system structure for the GPIB remote control system.

Figure 2-1

Structure example of GPIB remote control system

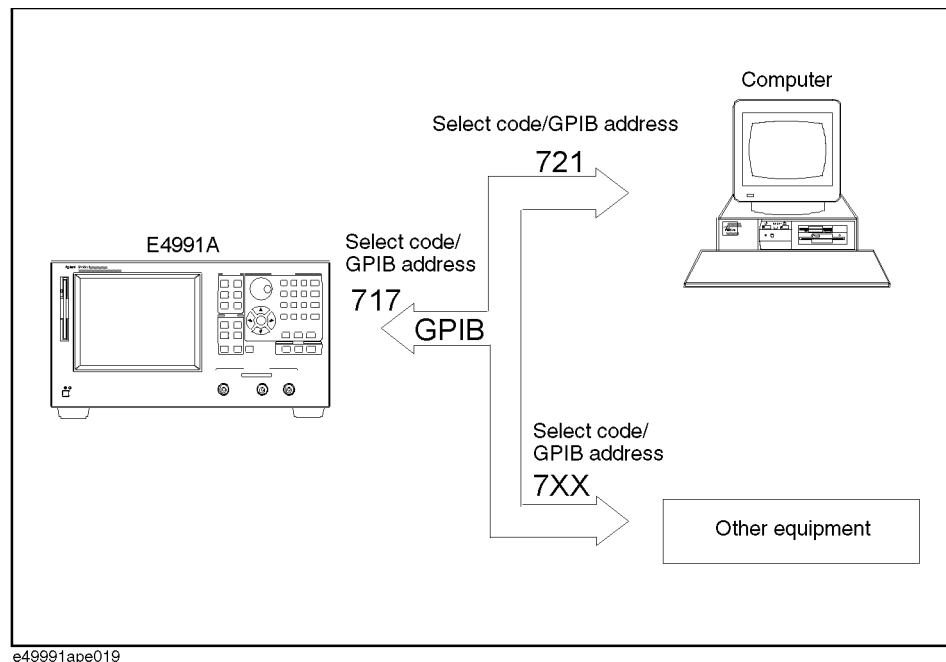

### What is GPIB?

GPIB (General-Purpose Interface Bus) is an interface standard for connecting computers and peripheral equipment. It supports worldwide standards such as IEEE 488.1, IEC-625, IEEE 488.2 and JIS-C1901. By using the GPIB interface, the E4991A can be controlled from an external computer. The computer sends commands and instructions to the E4991A and receives data sent from it through GPIB.

## Required equipment

1. The Agilent E4991A RF Impedance/Material Analyzer and the accessories required to measure a DUT



When using an external computer as the system controller, it is necessary to set the E4991A in addressable-only mode and set the GPIB address as required. This setting is made by the following front panel operation.

- a. Set the E4991A in addressable-only mode.

**System - GPIB Setup...** - Control Mode [Addressable Only]

- b. Set the GPIB address of the E4991A.

**System - GPIB Setup...** - E4991A Address: (drop-down box)

- c. Turn the E4991A's main power off and then back on again.

2. GPIB system controller



To use an external computer as the system controller, a Personal Computer (IBM compatible) or work station with a GPIB interface is required. Also, software such as Agilent VEE, Microsoft Visual Basic, or HTBasic is required to control the E4991A through GPIB.

3. Peripheral equipment depending on the user's purpose
4. GPIB cable (10833A/B/C/D) to connect the computer to the E4991A and peripheral equipment

### The sizes and configurations of possible GPIB systems

- A maximum of 15 devices can be connected to one GPIB system.
- Keep the length of cable between devices within 1 m. The total length of connecting cable in a single GPIB system should not exceed  $2 \text{ m} \times$  the number of connected devices (the controller is counted as one device). Also, you cannot construct a system having more than 20 m in total cable length.
- The number of connectors on a single device should not exceed 4. More than that will cause strain on the connector parts, which could lead to equipment breakdown.
- The pattern of connection can be star topology, linear topology or a combination of both. However, loop topology cannot be used.

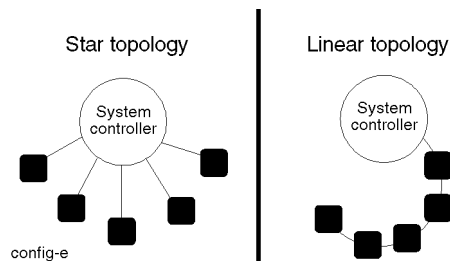

### Controller

The device that allows talk (data output) or listen (data receipt) by the GPIB device is called the controller.

An active controller can control other devices on the bus (if multiple controllers are connected). Only one controller can be active at any one time. By executing the pass control, the active controller can pass the controlling right to another controller (pass control function).

---

### NOTE

When the E4991A is used in system controller mode, the controlling right cannot be passed to another controller or cannot be received from another computer because the E4991A does not support the pass control function.

---

### Device selector

Device control of GPIB is performed by sending a command by the active controller. The active controller can choose the target device by specifying the device selector.



## Sending GPIB command messages

### Learning about GPIB commands

To find information on a particular GPIB command, refer to the following sections in this book.

- The procedures used to write basic programs for the E4991A are explained from Chapter 2 to Chapter 11. Program examples using HTBasic are also given.
- Appendix C, “GPIB Command List By Function,” on page 565 provides a convenient list of GPIB commands according to the measurement or general-purpose functions they perform.
- “List of Functions by Menu” in the *Operation Manual* shows the correspondence of GPIB Commands to the front panel operation of the E4991A.
- Chapter 16, “Application Programs,” on page 253 shows E4991A application examples produced by using HTBasic.
- Chapter 17, “GPIB Command Reference,” on page 275 lists all of the GPIB commands used with the E4991A in alphabetical order.

### Type and structure of commands

The GPIB commands that can be used with the E4991A are classified into the following two groups.

#### E4991A commands

These commands are unique to the E4991A. They cover all of the instrument’s measurement functions and some of its general-purpose functions. The commands in this group have a hierarchical structure called a command tree. Each command is structured by a character string (mnemonic) to indicate the hierarchy and uses a colon (:) as a divisional marker between hierarchical levels.

#### IEEE common commands

These are the commands used to cover the general purpose functions defined by IEEE488.2. These can be commonly used by measurement equipment that support this standard. The commands in this group always start with an asterisk (\*). The commands in this group do not have a hierarchical structure.

**The concept of command tree**

The command at the highest-level position in the command tree hierarchy is called “root command” or simply “root.” To access a lower command in the tree structure’s hierarchy, a particular “path” has to be specified in the same way as a directory path in the DOS file system. The current path is set as “root” after the power is turned on or a reset is executed. Depending on the special symbols in the message, the setting of the path changes as follows.

**Message terminator**

A message terminator such as <new line> sets the current path as the “root.”

**Colon (:)**

When a colon is located between two command mnemonics, the colon lowers the level of the current path on the command tree. When it is used as the first character of a command, it specifies the command mnemonic to follow it as the command of root level.

**Semi-colon (;)**

A semi-colon divides two commands within one message without changing the current path.

Figure 2-2 shows an example of using the colon and semi-colon for efficient access of various commands within the command tree.

**Figure 2-2**

**Usage of colon and semi-colon**

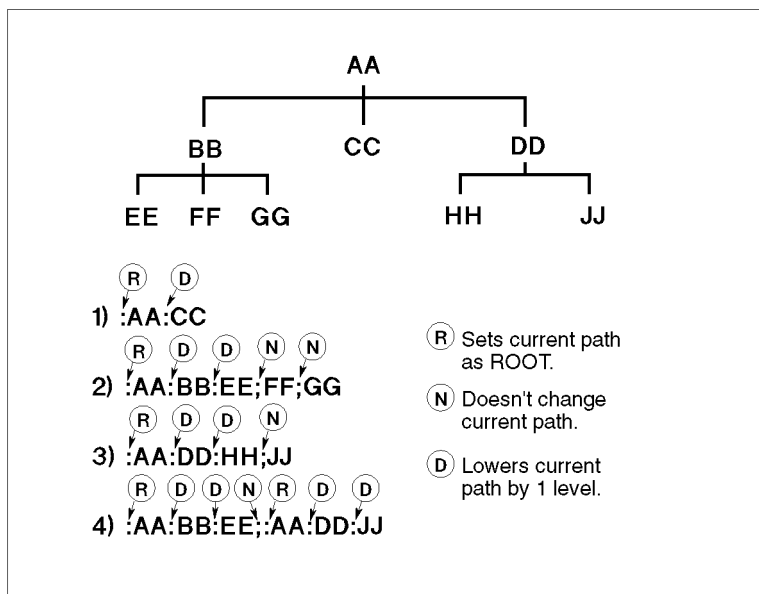

### Grammar for messages

The grammar used for sending program messages by GPIB is described below. Program message means a message sent to the measurement equipment by the user through an external computer for controlling the measurement equipment. A program message contains one or more commands and the parameters required for them.

### Handling of capital/small letters

No differentiation between capital and small letters

### Program message terminator

Program messages have to end with any one of these three program message terminators: <new line>, <^END>, and <new line><^END>. <END> means that EOI becomes the active level on the GPIB interface when the immediately preceding data byte is sent out. For example, the OUTPUT command of HTBasic automatically sends the message terminator after the last data byte.

### Parameter

A space (ASCII code 32) is required between a command and the first parameter. When multiple parameters are sent with one command, the parameters have to be divided by commas (.).

### Message that includes multiple commands

When sending two or more commands in one message, the commands have to be divided by semi-colons (;). The following is an example of sending the **\*CLS** command and the **INIT** command in the same message by HTBasic.

```
OUTPUT 717;"*CLS;:INIT"
```

### Remote mode

The E4991A doesn't have a remote mode. Therefore, it doesn't switch to remote mode even if it receives the relevant GPIB command. Also, there is no local key to release the remote mode.

When it is necessary to prevent operational error caused by mistaken input through the front panel or keyboard/mouse of the E4991A under remote control, use one of the following GPIB commands to lock the input device.

- **SYST:KLOC** on page 522 (locks front panel)
- **SYST:KLOC:KBD** on page 522 (locks keyboard)
- **SYST:KLOC:MOUS** on page 523 (locks mouse)

## Remote control using E4991A macros

This section describes the system structures and command sets used for controlling the E4991A and peripheral equipment with the instrument's macro functions.

### NOTE

The E4991A is shipped with a macro function. A macro allows you to automatically execute a series of multiple commands with a single command. Using a macro allows you to combine the steps of a complicated procedure into a single step for a wide variety of applications. A macro can also be used to control peripheral equipment. The E4991A VBA (Visual Basic for Application) is the programming language used to execute macro functions.

### System structure

Connect the E4991A to any peripheral equipment that can be connected with a GPIB cable. An outline of a remote control system using the macro functions is shown in Figure 2-3.

Figure 2-3

Structure example of GPIB remote control system

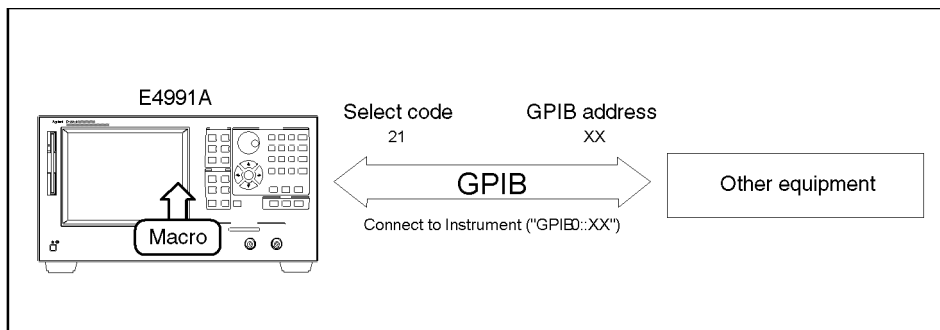

e4991ape020

## Required equipment

1. The Agilent E4991A RF Impedance/Material Analyzer and the accessories required to measure a DUT

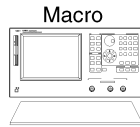

When using macro functions to control the E4991A, it is not necessary to select the system-controller mode or the addressable-only mode of the GPIB system.

However, to control peripheral equipment other than the E4991A, you must set the E4991A to the system-controller mode because control is done through the internal GPIB bus.

When the E4991A is used as the system controller, set the E4991A to system-controller mode and set the GPIB address as the system controller. This setting is made by the following front panel operation.

- a. Set the E4991A to system-controller mode.

**System - GPIB Setup...** - Control Mode [System Controller]

- b. Set the GPIB address of the system controller.

**System - GPIB Setup...** - Control Address: (drop-down box)

- c. Turn the E4991A's main power off and then back on again.

2. Peripheral equipment depending on the user's purpose
3. GPIB cable (10833A/B/C/D) to connect the E4991A and peripheral equipment

## Size and configuration of possible GPIB systems

For information on the type of GPIB system that can be constructed for controlling peripheral equipment, refer to "The sizes and configurations of possible GPIB systems" on page 28.

## How to operate macros

It is necessary to understand the basics of E4991A VBA, which is the programming language used for writing and executing macros. E4991A VBA is briefly explained in Chapter 13, "Use of Macros," on page 211. Refer to E4991A VBA help for more detailed information on the basics of E4991A VBA programming, standard control, and functions.

## **Sending command messages**

When controlling the E4991A or peripheral equipment by macro functions, the command set differs depending on the target of control.

### **Commands to control E4991A**

The command used to control the E4991A is written in the E4991A COM interface. The following two types of E4991A COM interfaces can be used. For combined use of the COM interface and a GPIB command provided by the E4991A, it is necessary to understand how to use the GPIB command.

- COM interface
- COM interface combined with GPIB command of the E4991A

For the basic method of using the E4991A COM interface, refer to Chapter 14, “Outline of Programming Using COM,” on page 237 and Chapter 18, “COM Interface Reference,” on page 527.

To find a GPIB command provided by the E4991A, refer to “Learning about GPIB commands” on page 29.

### **Commands to control peripheral equipment**

The macro used to control peripheral equipment is written by using the VISA library.

For the basic method of using the functions provided by the VISA library, refer to Chapter 15 on page 245. For details on how to use the VISA library, refer to the on-line help for VISA (accessible by opening the file named visa.hlp on the supplied CD-ROM (Agilent Parts No. E4991-90500)).

For how to use the GPIB commands of peripheral equipment, refer to the operation manual of the peripheral equipment.

## **Remote mode**

Unlike previous Agilent models, the E4991A does not have a “Remote mode” that automatically locks up operation of the front panel’s hardkeys when it is controlled through E4991A COM object. If necessary, the E4991A’s front panel can be locked by a command.

## Remote control using remote user interface function and application software

This section explains the system structures and command sets for controlling the E4991A by using a macro (E4991A VBA) installed in your personal computer with the remote user interface function.

### System structure

Connect the E4991A to a personal computer with a LAN cable. Figure 2-4 outlines the system structure for using the remote user interface function.

Figure 2-4

Structure of remote control system using remote U/I function

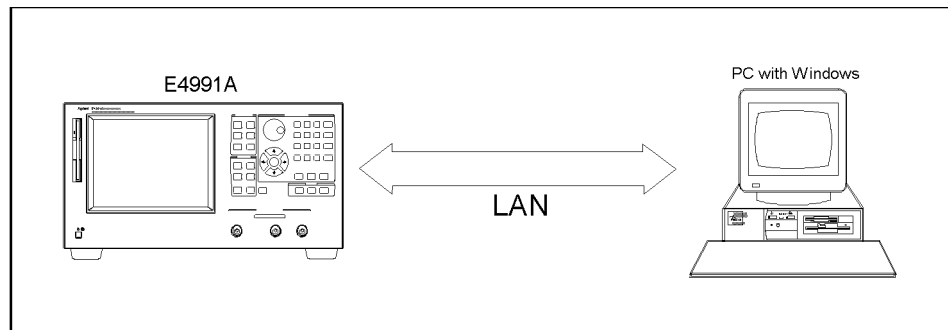

e4991apj021

**NOTE** Refer to the *Operation Manual* for setup instructions of the E4991A remote user interface function.

**NOTE** Peripheral equipment connected to the E4991A through GPIB cannot be controlled.

## Outline of Remote Control

### Remote control using remote user interface function and application software

#### Required equipment

1. The Agilent E4991A RF Impedance/Material Analyzer and the accessories required to measure a DUT

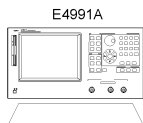

It is not necessary to select the system-controller mode or the addressable-only mode of the GPIB system.

2. Personal Computer



A personal computer (IBM compatible personal computer) with a LAN interface is required.

3. LAN cable to connect the E4991A and personal computer

#### How to use the application software

It is necessary to understand E4991A VBA in order to install and use the supplied E4991A VBA program on your personal computer. E4991A VBA is briefly explained in Chapter 13, “Use of Macros,” on page 211. Refer to E4991A VBA help for more detailed information on the basics of E4991A VBA programming, standard control, and functions.

---

**NOTE**

Refer to the operation manual for instructions on installing the E4991A VBA program on your personal computer.

---

**NOTE**

Agilent Technologies shall not guarantee operation of the E4991A COM if the customer uses application software other than E4991A VBA (Visual Basic for Application).



## **Sending command messages**

Basically, the commands used to control the E4991A are written in the E4991A COM interface. The following two types of E4991A COM interfaces can be used. To use the COM interface in combination with the GPIB command offered by the E4991A, it is necessary to understand how to use GPIB command.

- COM interface
- COM interface combined with GPIB command

For the basic method of using the E4991A COM interface, refer to Chapter 14, “Outline of Programming Using COM,” on page 237 and Chapter 18, “COM Interface Reference,” on page 527.

To find a GPIB command provided by the E4991A, refer to “Learning about GPIB commands” on page 29.

## **Remote mode**

Unlike previous Agilent models, the E4991A does not have a “Remote mode” that automatically locks up operation of the front panel’s hardkeys when it is controlled through E4991A COM object. If necessary, the E4991A’s front panel can be locked by a command.

Outline of Remote Control

**Remote control using remote user interface function and application software**

---

## **3**      **Setting Measurement Conditions**

This chapter explains how to set the measurement conditions of the Agilent E4991A.

## Set Measurement Parameter

The measurement mode (Impedance/Magnetic/Dielectric measurement) and the display trace type (Scalar/Complex trace) determine the parameters available. The following section explains how to set the measurement parameters.

### Measurement Mode

#### Selection

When material measurement is performed by using the E4991A with option 002 (Material Measurement), use the following GPIB command to set the measurement mode to magnetic measurement or dielectric measurement. The E4991A without Option 002 sets the measurement mode to impedance.

- **MODE** on page 393

#### Parameters for Material Measurement

Before dielectric material measurement can be performed, the following GPIB command must be used to set the thickness of the device under test.

- **CALC:FORM:PAR:DIE** on page 300

Before magnetic material measurement can be performed, the following GPIB command must be used to set the sizes (inner and outer diameters and height) of the device under test.

- **CALC:FORM:PAR:MAG** on page 302

### Display Trace

The E4991A allows the user to display up to five traces. Use the following GPIB command to display a trace.

- **DISP:TRAC{1-5}** on page 356

Of the five traces, Traces 1-3 are for scalar traces and Traces 4 -5 are for complex traces.

### Parameters for Scalar Trace

#### Measurement Parameters

Table 3-1 shows measurement parameters available for a scalar trace. Use the following GPIB command to specify a trace number (1, 2, or 3) and select measurement parameters. Note that up to three measurement parameters can be displayed at a time.

- **CALC{1-5}:FORM** on page 298

Table 3-1

Measurement Parameters for Scalar Trace

Measurement parameter	GPIB parameter	Description
Z	Z	Absolute value of impedance
Y	Y	Absolute value of admittance
Ls	LS	Equivalent serial inductance
Lp	LP	Equivalent parallel inductance
Cs	CS	Equivalent serial capacitance
Cp	CP	Equivalent parallel capacitance
Rs	RS	Equivalent serial resistance
Rp	RP	Equivalent parallel resistance
D	D	Dissipation factor
Q	Q	Quality factor (reciprocal of dissipation factor)
R	R	Serial resistance
X	X	Reactance
G	G	Conductance
B	B	Susceptance
$\theta_z$	ZPH	Phase of impedance
$\theta_y$	YPH	Phase of admittance
$\Gamma$	RC	Absolute value of reflection coefficient
$\theta_\gamma$	RCPH	Phase of reflection coefficient
$\Gamma_x$	RCX	Real part of reflection coefficient
$\Gamma_y$	RCY	Imaginary part of reflection coefficient
$ \mu_r $	P	Absolute value of complex permeability *1
$\mu_r'$	PRE	Real part of complex permeability *1
$\mu_r''$	PLF	Imaginary part of complex permeability *1 *1
$\tan\delta(\mu)$	PLT	Magnetic loss tangent *1
$ \epsilon_r $	DC	Absolute value of complex permittivity *2

**Table 3-1**

**Measurement Parameters for Scalar Trace**

Measurement parameter	GPIB parameter	Description
$\epsilon_r'$	DCR	Real part of complex permittivity* <sup>2</sup>
$\epsilon_r''$	DCLF	Imaginary part of complex permittivity *1* <sup>2</sup>
$\tan\delta(\epsilon)$	DCLT	Dielectric loss tangent* <sup>2</sup>

\*1. Parameters selectable when the Magnetic Material measurement mode is selected.

\*2. Parameters selectable when the Dielectric Material measurement mode is selected.

### Display Format

Use the following GPIB command to set the display format to Rectangular format:

- **DISP:TRAC{1-5}:GRAT:FORM** on page 357

If the Rectangular format is selected, the following GPIB command can be used to set the Y-axis scale to either Liner or Log.

- **DISP:TRAC{1-3}:Y:SPAC** on page 371

### Phase Display for Scalar Trace

When the measurement parameter is phase for a scalar trace, use the following GPIB commands to set the unit and to turn on/off expanded phase display.

#### Set Unit

Use the following GPIB command to set the unit (degree or radian) in which phase is displayed:

- **CALC{1-5}:FORM:UNIT:ANGL** on page 303

#### Expanded Phase Display

The following GPIB command can be used to turn on/off the expanded phase display (in which phases less than -180 degree and more than +180 degree are not folded):

- **CALC{1-3}:FORM:PAR:EPH** on page 301

**Parameters for Complex Trace**

**Measurement parameters**

Table 3-2 shows measurement parameters available for a complex trace. Use the following GPIB command to specify a trace number (4 or 5) and select measurement parameters. Note that up to two measurement parameters can be displayed at any one time.

- **CALC{1-5}:FORM** on page 298

**Table 3-2**

**Measurement Parameters for Complex Trace**

Measurement parameter	GPIB parameter	Description
Z	Z	Impedance
Y	Y	Admittance
$\Gamma$	RC	Reflection coefficient
$\mu r$	P	Complex permeability *1
$\epsilon r$	DC	Complex permittivity *2

\*1. Parameters selectable when the Magnetic Material measurement mode is selected.  
 \*2. Parameters selectable when the Dielectric Material measurement mode is selected.

**Display Format**

Table 3-3 shows display formats available for a complex trace. Use the following GPIB command to select a display format from Complex plane format, Polar format, Smith chart, or Admittance chart.

- **DISP:TRAC{1-5}:GRAT:FORM** on page 357

**Table 3-3**

**Display Format for Complex Trace**

Measurement parameters	Display format
Z,Y, $\mu r$ , $\epsilon r$	Complex plane or Polar format
$\Gamma$	Complex plane format, Polar format, Smith chart, or Admittance chart

## Set Sweep Conditions

The following section explains how to set the sweep conditions. The sweep condition is a common parameter to all of traces.

### Select Sweep Parameter

The user must select a desired combination of a sweep parameter and a sweep type. E4991A provides the following combinations of four sweep parameters and three sweep types.

- Frequency sweep (Linear sweep)
- Frequency sweep (Log sweep)
- Frequency sweep (Segment sweep)
- Oscillator level sweep (Linear sweep)
- dc bias voltage sweep<sup>\*1</sup> (Linear sweep)
- dc bias current sweep<sup>\*1</sup> (Linear sweep)

Use the following GPIB command to select both sweep parameter and sweep type.

- **SWE:TYPE** on page 515

---

#### NOTE

Segment conditions must be set in the segment sweep table before the sweep type is set to Segment sweep. For details on how to create the segment sweep table, see “Combination of Several Sweep Conditions (Segment Sweep)” on page 64.

---

### Set Number of Measurement Points

Use the following GPIB command to set the number of measurement points for one sweep.

- **SWE:POIN** on page 511

### Set Sweep Direction

Use the following GPIB command to set the sweep direction to UP or DOWN.

- **SWE:DIR** on page 508

---

\*1. Selectable when the E4991A has option 001 (dc bias function) installed.



### Set Sweep Range

Sweep range can be set in two ways: by specifying the center value and span value of the sweep range or by specifying the sweep start value and sweep stop value. Use the following GPIB commands to set a sweep range.

**NOTE**

When sweep start or stop values are changed, center and span values are also changed accordingly.

The E4991A provides a GPIB command to specify the sweep range for each sweep parameter.

#### Frequency Sweep (Linear/Log Sweep)

If frequency sweep is selected as the sweep parameter, use the following GPIB commands to set a sweep range.

Sweep parameter	Sweep range	GPIB command
Frequency sweep	Start value	<b>FREQ:STAR</b> on page 378
	Stop value	<b>FREQ:STOP</b> on page 379
	Center value	<b>FREQ:CENT</b> on page 376
	Span value	<b>FREQ:SPAN</b> on page 377
	Full span value	<b>FREQ:SPAN:FULL</b> on page 377

#### Oscillator Level Sweep

When oscillator level sweep is selected as the sweep parameter, note that the GPIB command used to set the sweep range depends on the unit in which an oscillator level is set (current/voltage/dBm). From the following table, select the appropriate GPIB commands to set the sweep range and to set the oscillator level mode to sweep mode.

Sweep parameter	Mode/sweep range	GPIB command	
Oscillator level sweep	Set in current	Mode	<b>SOUR:CURR:MODE</b> on page 460
		Start value	<b>SOUR:CURR:STAR</b> on page 468
		Stop value	<b>SOUR:CURR:STOP</b> on page 469
		Center value	<b>SOUR:CURR:CENT</b> on page 458
		Span value	<b>SOUR:CURR:SPAN</b> on page 467
	Set in voltage	Mode	<b>SOUR:VOLT:MODE</b> on page 479
		Start value	<b>SOUR:VOLT:STAR</b> on page 487
		Stop value	<b>SOUR:VOLT:STOP</b> on page 488
		Center value	<b>SOUR:VOLT:CENT</b> on page 477
		Span value	<b>SOUR:VOLT:SPAN</b> on page 486
	Set in dBm	Mode	<b>SOUR:POW:MODE</b> on page 472
		Start value	<b>SOUR:POW:STAR</b> on page 474
		Stop value	<b>SOUR:POW:STOP</b> on page 475
		Center value	<b>SOUR:POW:CENT</b> on page 471
		Span value	<b>SOUR:POW:SPAN</b> on page 473

## Setting Measurement Conditions

### Set Sweep Conditions

#### DC Bias Voltage Sweep

If dc bias voltage sweep is selected as the sweep parameter, use one of the following GPIB commands to set the sweep range.

Sweep parameter	Sweep range	GPIB command
dc bias voltage sweep	Start value	<b>SOUR:VOLT:OFFS:STAR</b> on page 483
	Stop value	<b>SOUR:VOLT:OFFS:STOP</b> on page 485
	Center value	<b>SOUR:VOLT:OFFS:CENT</b> on page 481
	Span value	<b>SOUR:VOLT:OFFS:SPAN</b> on page 482

After setting up a sweep range, use the following GPIB command to set the dc bias current limit maximum value.

- **SOUR:CURR:LIM:OFFS** on page 459

Use the following GPIB command to turn on or off the dc bias output. When the dc bias output is turned on from off, the sweep mode is automatically set to hold mode.

- **SOUR:VOLT:OFFS:STAT** on page 484

#### DC Bias Current Sweep

If dc bias current sweep is selected as a sweep parameter, use one of the following GPIB commands to set the sweep range.

Sweep parameter	Sweep range	GPIB command
dc bias current sweep	Start value	<b>SOUR:CURR:OFFS:STAR</b> on page 464
	Stop value	<b>SOUR:CURR:OFFS:STOP</b> on page 466
	Center value	<b>SOUR:CURR:OFFS:CENT</b> on page 462
	Span value	<b>SOUR:CURR:OFFS:SPAN</b> on page 463

After setting the sweep range, use the following GPIB command to set the maximum value of the dc bias voltage limit.

- **SOUR:VOLT:LIM:OFFS** on page 478

Use the following GPIB command to turn on or off the dc bias output. When the dc bias output is turned on from off, the sweep mode is automatically set to hold mode.

- **SOUR:CURR:OFFS:STAT** on page 465

## Set Sweep Time

Use the following GPIB command to select whether the sweep time is set to automatic setting or manual setting. If automatic setting is selected, this sets the shortest sweep time from among all of the E4991A pre-defined sweep times.

- **SWE:TIME:AUTO** on page 514

If manual setting is selected, use the following GPIB command to perform sweep within the specified sweep time.

- **SWE:TIME** on page 513

## Set Delay Time

The delay time can be set at the sweep start or at each measurement point, if necessary.

### Set Sweep Delay Time at Sweep Start

The following GPIB command can be used to delay the sweep start by the specified time. Note that when the sweep time is set to automatic setting, the delay time at the sweep start is set to 0 second.

- **SWE:DWEL1** on page 508

### Set Delay Time at Each Measurement Point

The following GPIB command can be used to delay the measurement at each measurement point by the specified time. Note that when the sweep time is set to automatic setting, the delay time at each measurement point is set to 0 second.

- **SWE:DWEL2** on page 509

### Set Delay Time at Each Segment (only segment sweep)

The following GPIB command can be used to delay the sweep start for each segment by the specified time. Note that when the sweep time is set to automatic setting, the delay time at each segment is set to 0 second.

- **SWE:DWEL3** on page 510

## Set Frequency Span (only segment sweep)

The following GPIB command can be used to select whether a frequency span during segment sweep is displayed for each segment or the minimum and maximum frequencies are selected from all segments. The new span between the minimum and maximum frequencies is displayed as a frequency span during segment sweep.

- **DISP:TRAC{1-5}:X:SPAC** on page 363

## Set Measurement Source

The following section explains how to set a measurement source. The measurement source is a parameter common to all of the traces.

### Set Source

#### Set CW Frequency

If the sweep parameter is set to oscillator level sweep, dc bias voltage sweep, or dc bias current sweep, use the following GPIB command to set the CW frequency.

- **FREQ** on page 375

#### Set Oscillator Level

If the sweep parameter is set to frequency sweep, dc bias voltage sweep, or dc bias current sweep, note that the GPIB command used to set the oscillator level depends on the unit in which the oscillator level is set (current/voltage/power). Select the appropriate GPIB commands to set the oscillator mode to fixed mode and to set an output level value.

Oscillator level	Parameter to be set	GPIB command
Set in voltage	Mode	<b>SOUR:VOLT:MODE</b> on page 479
	Output level value	<b>SOUR:VOLT</b> on page 476
Set in current	Mode	<b>SOUR:CURR:MODE</b> on page 460
	Output level value	<b>SOUR:CURR</b> on page 457
Set in power (dBm)	Mode	<b>SOUR:POW:MODE</b> on page 472
	Output level value	<b>SOUR:POW</b> on page 470

### Set DC Bias (DC Bias Function)

If the sweep parameter is set to frequency sweep or oscillator level sweep, the following GPIB command can be used to apply the dc bias to the DUT in either fixed voltage or current source mode.

#### Set in Fixed Voltage Source Mode

Output mode	Parameter to be set	GPIB command
Fixed voltage source	Output voltage level	<b>SOUR:VOLT:OFFS</b> on page 480
	Current limit maximum value	<b>SOUR:CURR:LIM:OFFS</b> on page 459

Use the following GPIB command to turn on or off the dc bias output. Note that when the dc bias is turned on from off, the sweep mode is automatically set to hold mode.

- **SOUR:VOLT:OFFS:STAT** on page 484

#### Set in Fixed Current Source Mode

Output mode	Parameter to be set	GPIB command
Fixed current source	Output current level	<b>SOUR:CURR:OFFS</b> on page 461
	Voltage limit maximum value	<b>SOUR:VOLT:LIM:OFFS</b> on page 478

Use the following GPIB command to turn on or off the dc bias output. Note that when the dc bias is turned on from off, the sweep mode is automatically set to hold mode.

- **SOUR:CURR:OFFS:STAT** on page 465

#### DC Bias Monitor Function

The following GPIB command can be used to display a dc bias monitor value.

- **CALC:BMON** on page 291

---

#### NOTE

The dc bias monitor value displayed on the screen is that of the stimulus at an active marker position. Therefore, the marker must be turned on and the marker must be set to the specified stimulus value before the dc bias monitor function can be used.

---

## Set Averaging

The E4991A has two types of averaging functions: sweep averaging and point averaging (Figure 3-1).

### Sweep Averaging

Use the following GPIB command to turn sweep averaging on or off.

- **CALC:AVER** on page 289

After enabling sweep averaging, use the following GPIB command to set the averaging factor.

- **CALC:AVER:COUN** on page 290

The following GPIB command can be used to restart the sweep.

- **CALC:AVER:CLE** on page 289

### Point Averaging

Use the following GPIB command to turn point averaging on or off.

- **AVER** on page 287

After enabling point averaging, use the following GPIB command to set the averaging factor.

- **AVER:COUN** on page 288

Figure 3-1

Sweep Averaging and Point Averaging

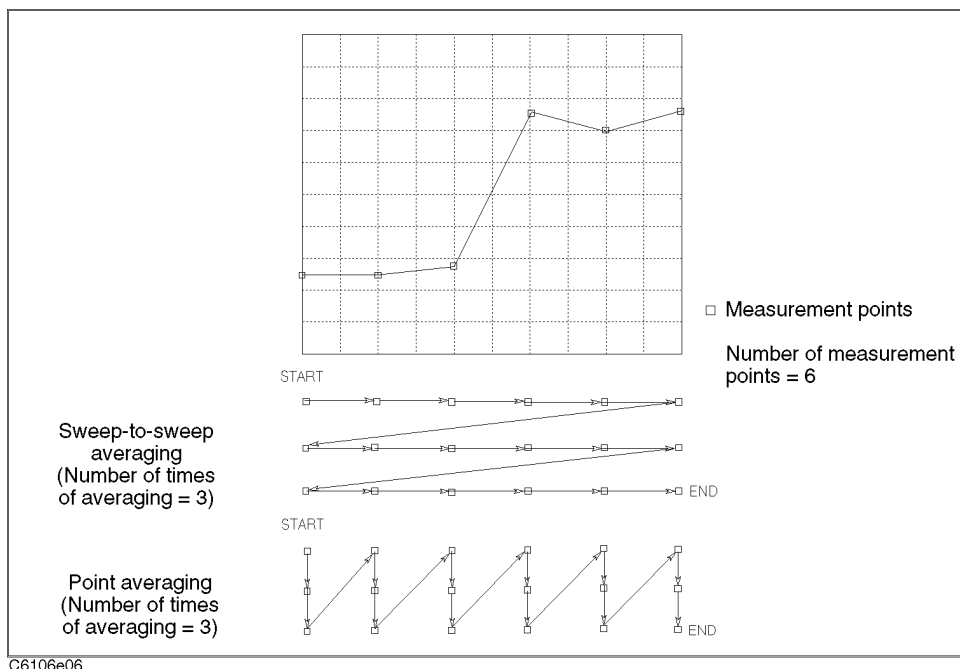

## Set Display Scale

When the measurement screen is set to display a graph, the display scale for the specified trace can be set automatically to the most appropriate value or can be set manually to a desired value.

### Select Trace for Which Scale Is Set

If both data and memory traces are displayed on the screen, use the following GPIB command to select the trace (data trace, memory trace, or both traces) for which the scale is to be set.

- **DISP:TRAC{1-5}:Y:FOR** on page 366

### Automatic Scale Adjustment

When a trace goes out of the scale range, use the following GPIB command to adjust the scale automatically so that the trace stays within the scale range.

- **DISP:TRAC{1-5}:Y:AUTO** on page 364
- **DISP:TRAC:Y:AUTO:ALL** on page 364

### Manual Setting of Scale

In addition to automatic scale adjustment, the E4991A provides a way to manually set the scale values. As shown in Figure 3-2, scale parameters depend on the display format of a trace.

#### Linear Y-Axis Format

The display scale can be set in two ways: by using full-scale and reference values or by using maximum and minimum values. Use the following GPIB commands to set the scale parameters.

Display format	Parameter to be set	GPIB command
Linear Y-axis format (Using max and min values)	Maximum value	<b>DISP:TRAC{1-3}:Y:TOP</b> on page 372
	Minimum value	<b>DISP:TRAC{1-3}:Y:BOTT</b> on page 365
	Reference line's position	<b>DISP:TRAC{1-3}:Y:RPOS</b> on page 370
Linear Y-axis format (Using full-scale)	Full-scale value	<b>DISP:TRAC{1-5}:Y:FULL</b> on page 367
	Reference line's value	<b>DISP:TRAC{1-5}:Y:RLEV</b> on page 369
	Reference line's position	<b>DISP:TRAC{1-3}:Y:RPOS</b> on page 370

## Setting Measurement Conditions

### Set Display Scale

#### Log Y-Axis Format

Use the following GPIB commands to set the maximum and minimum values of the scale.

Display format	Parameter to be set	GPIB command
Log Y-axis format	Maximum value	<b>DISP:TRAC{1-3}:Y:TOP</b> on page 372
	Minimum value	<b>DISP:TRAC{1-3}:Y:BOTT</b> on page 365

#### Polar Format

Use the following GPIB command to set the scale value of the outermost circle.

- **DISP:TRAC{1-5}:Y:FULL** on page 367

#### Complex Plane Format

Use the following GPIB commands to set the X-axis and Y-axis reference values and a full-scale value.

Display format	Parameter to be set	GPIB command
Complex plane format	X-axis reference value	<b>DISP:TRAC{4-5}:X:RLEV</b> on page 362
	Y-axis reference value	<b>DISP:TRAC{1-5}:Y:RLEV</b> on page 369
	Full-scale value	<b>DISP:TRAC{1-5}:Y:FULL</b> on page 367

#### Smith Chart and Admittance Chart

The scales of these formats are fixed and thus cannot be changed.



Figure 3-2

Display Scale Parameters

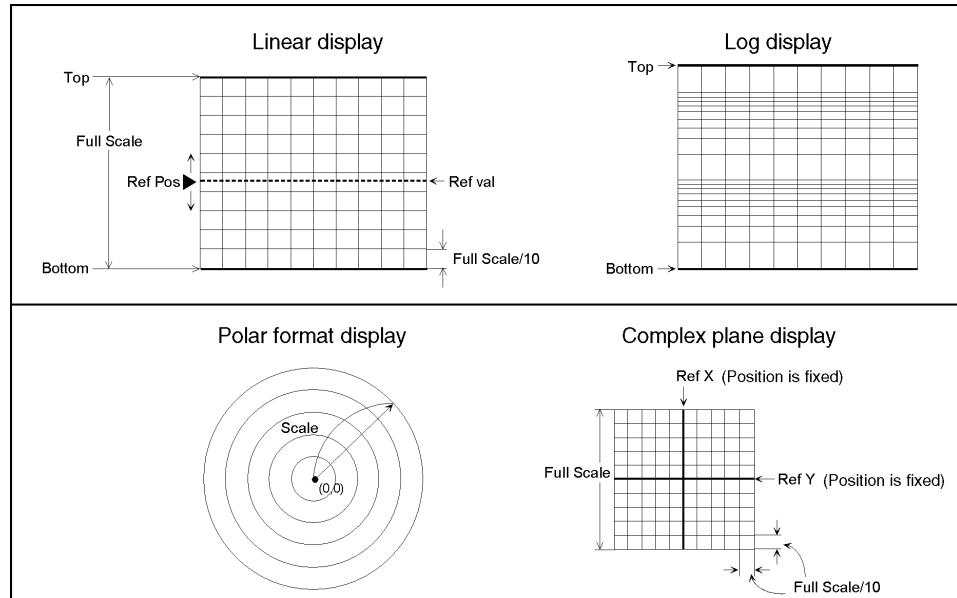

e4991ape022

Use the following GPIB commands to set the scale parameters shown in Figure 3-2.

Full Scale	<b>DISP:TRAC{1-5}:Y:FULL</b> on page 367
Full Scale/10 <sup>*1</sup>	<b>DISP:TRAC{1-5}:Y:PDIV</b> on page 368
Top	<b>DISP:TRAC{1-3}:Y:TOP</b> on page 372
Bottom	<b>DISP:TRAC{1-3}:Y:BOTT</b> on page 365
Ref Pos	<b>DISP:TRAC{1-3}:Y:RPOS</b> on page 370
Ref Val	<b>DISP:TRAC{1-5}:Y:RLEV</b> on page 369
Ref X	<b>DISP:TRAC{4-5}:X:RLEV</b> on page 362
Ref Y	<b>DISP:TRAC{1-5}:Y:RLEV</b> on page 369

\*1. With the display format set to Linear display or Complex plane, one-tenth of the full-scale value can be used instead. However, one-tenth of the full-scale does not always correspond to a grid width (Grid lines are not always displayed at an interval of one-tenth of the full-scale).

## Example program for setting the measuring conditions

An example program for setting the measuring conditions is shown below. This program sets the E4991A as follows after resetting it. When the setting is complete, a completion message is displayed.

Setting item	Trace 1	Trace 2	Trace 4
Measurement mode	Impedance measurement		
Display trace	Scalar	Scalar	Complex
Measurement parameter	Z	$\theta_z$	$\Gamma$
Display format	Log Y-axis	Linear Y-axis	Smith
Phase display unit	---	° (degrees)	---
Expanded phase display	---	On	---
Sweep parameter (sweep type)	Frequency sweep (log sweep)		
Start frequency	100 MHz		
Stop frequency	3 GHz		
Number of measurement points	201		
Measurement direction	Up		
Sweep averaging factor	16		
Point averaging factor	0 (off)		
Sweep time	Auto		
Delay time at the start of sweep	0 seconds		
Delay time at each measurement point	0 seconds (When the sweep time is auto, the delay time is 0 seconds)		
Oscillator level	1 mA		
dc bias output voltage level	15 V		
dc bias current limit maximum value	10 mA		
Full-scale value	---	500	---
Reference value	---	0	---
Reference position	---	50	---
Maximum scale	100	---	---
Minimum scale	0.1	---	---

### Example program using HTBasic

The program shown in Example 3-1 is saved under the filename setup.htb on the sample programs disk. The details of this program are explained as follows.

Line 230	Sets the GPIB address of the E4991A.
Lines 250 - 290	Substitutes a variable for the trace number.
Lines 310 - 450	Substitutes variables for the on/off status of each trace display, measurement parameter, trace display format, and Y-axis display format. In addition, when the measurement parameter is a phase (Trace 2), substitutes variables for the expanded phase display and the phase display format display unit.
Lines 470 - 510	Substitutes variables for the sweep-related parameter values (sweep parameter/type, sweep range, number of measurement points, and sweep direction).
Lines 520 - 540	Substitutes variables for the average-related parameter values (sweep averaging and point averaging).
Lines 550 - 560	Substitutes variables for the auto/manual setting of the sweep time and sweep delay time.
Lines 570 - 580	Substitutes variables for the oscillator level-related parameters.
Lines 590 - 600	Substitutes variables for the dc bias-related parameter values.
Lines 620 - 670	Substitutes variables for the on/off status of the list display of the measurement screen and the object of the display trace (data trace/memory trace).
Lines 680 - 720	Substitutes variables for the display scale-related parameter values.
Line 740	Resets the E4991A.
Line 780	Sets the E4991A to impedance measurement mode.
Lines 800 - 940	Sets the measurement parameters for Traces 1, 2, and 4, the trace display format, and the Y-axis display format. In addition, for Trace 2, sets the expanded phase display as well as the display units of the phase display format.
Lines 960 - 970	Turns off Traces 3 and 5.
Line 1010	Sets the sweep parameter (type).
Lines 1030 - 1040	Sets the sweep range for the frequency sweep range.
Lines 1060 - 1120	Sets the measurement point, sweep direction, Sweep averaging function on/off status, averaging factor, point averaging function on/off status, auto/manual setting of the sweep time, and sweep delay time.
Lines 1060 - 1120	Selects the fixed mode for oscillator current mode and sets the oscillator current level. Next, sets the voltage level in the dc bias fixed mode and sets the maximum value of the dc bias current limit.
Lines 1230 - 1390	Sets the display scales of Traces 1, 2, and 4.
Line 1430	Turns on the dc bias output.
Line 1470	Displays a setting completion message.

## Setting Measurement Conditions

### Example program for setting the measuring conditions

#### Example 3-1

#### Setting measuring conditions (HTBasic)

```
10     INTEGER Trc1,Trc2,Trc3,Trc4,Trc5
20     INTEGER Nop,Sweep_avg_coun
30     REAL Start_freq,Stop_freq,Sweep_delay
40     REAL Sour_curr,Dc_bias_v,Dc_bias_i_lim
50     REAL Full_sacle1,Full_scale2,Full_scale4
60     REAL Ref_val1,Ref_val2,Ref_val4
70     REAL Ref_pos1,Ref_pos2,Ref_pos4
80     REAL Top_scale1,Top_scale2,Top_scale4
90     REAL Bottom_scale1,Bottom_scale2,Bottom_scale4
100    DIM Trac1$(3),Trac2$(3),Trac3$(3),Trac4$(3),Trac5$(3)
110    DIM M_para1$(4),M_para2$(4),M_para4$(4)
120    DIM Disp_form1$(10),Disp_form2$(10),Disp_form4$(10)
130    DIM Disp_y_spac1$(11),Disp_y_spac2$(11),Disp_y_spac4$(11)
140    DIM Phase_unit1$(3),Phase_unit2$(3),Phase_unit4$(3)
150    DIM Phase_exp1$(3),Phase_exp2$(3),Phase_exp4$(3)
160    DIM
Sweep_type$(11),Sweep_dir$(4),Sweep_avg$(3),Point_avg$(3)
170    DIM Sweep_t_auto$(3),Sour_curr_mode$(5)
180    DIM List_page1$(3),List_page2$(3),List_page4$(3)
190    DIM Disp_trac1$(4),Disp_trac2$(4),Disp_trac4$(4)
200    DIM Buff$(9)
210    !
220    CLEAR SCREEN
230    ASSIGN @Agte4991a TO 717
240    !
250    Trc1=1
260    Trc2=2
270    Trc3=3
280    Trc4=4
290    Trc5=5
300    !
310    Trac1$="ON"
320    Trac2$="ON"
330    Trac3$="OFF"
340    Trac4$="ON"
350    Trac5$="OFF"
360    M_para1$="Z"
370    M_para2$="ZPH"
380    M_para4$="RC"
390    Disp_form1$="RECT"
400    Disp_form2$="RECT"
410    Disp_form4$="SMIT"
420    Disp_y_spac1$="LOG"
430    Disp_y_spac2$="LIN"
440    Phase_unit2$="DEG"
450    Phase_exp2$="ON"
460    !
470    Sweep_type$="LOG"
480    Start_freq=1.00E+8
490    Stop_freq=3.E+9
500    Nop=201
510    Sweep_dir$="UP"
520    Sweep_avg_coun=16
530    Sweep_avg$="ON"
540    Point_avg$="OFF"
```

## Setting Measurement Conditions

### Example program for setting the measuring conditions

```
550 Sweep_t_auto$="ON"
560 Sweep_delay=0
570 Sour_curr_mode$="FIX"
580 Sour_curr=1.E-3
590 Dc_bias_v=15
600 Dc_bias_i_lim=1.0E-2
610 !
620 List_page1$="OFF"
630 List_page2$="OFF"
640 List_page4$="OFF"
650 Disp_trac1$="DATA"
660 Disp_trac2$="DATA"
670 Disp_trac4$="DATA"
680 Top_scale1=100
690 Bottom_scale1=.1
700 Full_scale2=500
710 Ref_val2=0
720 Ref_pos2=50
730 !
740 OUTPUT @Agte4991a;"SYST:PRES"
750 !
760 ! Measurement Mode & Parameter & Disp Format Setting
770 !
780 OUTPUT @Agte4991a;"MODE IMP"
790 !
800 OUTPUT @Agte4991a;"DISP:TRAC"&VAL$(Trc1) & " "&Trac1$
810 OUTPUT @Agte4991a;"CALC"&VAL$(Trc1) & ":FORM "&M_para1$
820 OUTPUT @Agte4991a;"DISP:TRAC"&VAL$(Trc1) & ":GRAT:FORM
"&Disp_form1$
830 OUTPUT @Agte4991a;"DISP:TRAC"&VAL$(Trc1) & ":Y:SPAC
"&Disp_y_spac1$
840 !
850 OUTPUT @Agte4991a;"DISP:TRAC"&VAL$(Trc2) & " "&Trac2$
860 OUTPUT @Agte4991a;"CALC"&VAL$(Trc2) & ":FORM "&M_para2$
870 OUTPUT @Agte4991a;"DISP:TRAC"&VAL$(Trc2) & ":GRAT:FORM
"&Disp_form2$
880 OUTPUT @Agte4991a;"DISP:TRAC"&VAL$(Trc2) & ":Y:SPAC
"&Disp_y_spac2$
890 OUTPUT @Agte4991a;"CALC"&VAL$(Trc2) & ":FORM:UNIT:ANGL
"&Phase_unit2$
900 OUTPUT @Agte4991a;"CALC"&VAL$(Trc2) & ":FORM:PAR:EPH
"&Phase_exp2$
910 !
920 OUTPUT @Agte4991a;"DISP:TRAC"&VAL$(Trc4) & " "&Trac4$
930 OUTPUT @Agte4991a;"CALC"&VAL$(Trc4) & ":FORM "&M_para4$
940 OUTPUT @Agte4991a;"DISP:TRAC"&VAL$(Trc4) & ":GRAT:FORM
"&Disp_form4$
950 !
960 OUTPUT @Agte4991a;"DISP:TRAC"&VAL$(Trc3) & " "&Trac3$
970 OUTPUT @Agte4991a;"DISP:TRAC"&VAL$(Trc5) & " "&Trac5$
980 !
990 ! Sweep & Average Setting
1000 !
1010 OUTPUT @Agte4991a;"SWE:TYPE "&Sweep_type$
1020 !
1030 OUTPUT @Agte4991a;"FREQ:STAR "&VAL$(Start_freq)
1040 OUTPUT @Agte4991a;"FREQ:STOP "&VAL$(Stop_freq)
1050 !
```

## Setting Measurement Conditions

### Example program for setting the measuring conditions

```
1060 OUTPUT @Agte4991a;"SWE:POIN "&VAL$(Nop)
1070 OUTPUT @Agte4991a;"SWE:DIR "&Sweep_dir$
1080 OUTPUT @Agte4991a;"CALC:AVER:COUN "&VAL$(Sweep_avg_coun)
1090 OUTPUT @Agte4991a;"CALC:AVER "&Sweep_avg$
1100 OUTPUT @Agte4991a;"AVER "&Point_avg$
1110 OUTPUT @Agte4991a;"SWE:TIME:AUTO "&Sweep_t_auto$
1120 OUTPUT @Agte4991a;"SWE:DWEL1 "&VAL$(Sweep_delay)
1130 !
1140 ! Source Setting
1150 !
1160 OUTPUT @Agte4991a;"SOUR:CURR:MODE "&Sour_curr_mode$
1170 OUTPUT @Agte4991a;"SOUR:CURR "&VAL$(Sour_curr)
1180 OUTPUT @Agte4991a;"SOUR:VOLT:OFFS "&VAL$(Dc_bias_v)
1190 OUTPUT @Agte4991a;"SOUR:CURR:LIM:OFFS "&VAL$(Dc_bias_i_lim)
1200 !
1210 ! Trace1 Setting
1220 !
1230 OUTPUT @Agte4991a;"DISP:TRAC"&VAL$(Trc1)&":TEXT
"&List_page1$
1240 OUTPUT @Agte4991a;"CALC"&VAL$(Trc1)&":MATH:FUNC
"&Disp_trac1$
1250 OUTPUT @Agte4991a;"DISP:TRAC"&VAL$(Trc1)&":Y:TOP
"&VAL$(Top_scale1)
1260 OUTPUT @Agte4991a;"DISP:TRAC"&VAL$(Trc1)&":Y:BOT
"&VAL$(Bottom_scale1)
1270 !
1280 ! Trace2 Setting
1290 !
1300 OUTPUT @Agte4991a;"DISP:TRAC"&VAL$(Trc2)&":TEXT
"&List_page2$
1310 OUTPUT @Agte4991a;"CALC"&VAL$(Trc2)&":MATH:FUNC
"&Disp_trac2$
1320 OUTPUT @Agte4991a;"DISP:TRAC"&VAL$(Trc2)&":Y:FULL
"&VAL$(Full_scale2)
1330 OUTPUT @Agte4991a;"DISP:TRAC"&VAL$(Trc2)&":Y:RLEV
"&VAL$(Ref_val2)
1340 OUTPUT @Agte4991a;"DISP:TRAC"&VAL$(Trc2)&":Y:RPOS
"&VAL$(Ref_pos2)
1350 !
1360 ! Trace4 Setting
1370 !
1380 OUTPUT @Agte4991a;"DISP:TRAC"&VAL$(Trc4)&":TEXT
"&List_page4$
1390 OUTPUT @Agte4991a;"CALC"&VAL$(Trc4)&":MATH:FUNC
"&Disp_trac4$
1400 !
1410 ! DC Bias ON
1420 !
1430 OUTPUT @Agte4991a;"SOUR:VOLT:OFFS:STAT ON"
1440 !
1450 OUTPUT @Agte4991a;"*OPC?"
1460 ENTER @Agte4991a;Buff$
1470 PRINT "Measurement Condition Setup Complete"
1480 !
1490 END
```

### Example program using macro (E4991A VBA)

The program shown in Example 3-2 is saved under the filename setup.bas on the sample programs disk. The details of this program are explained as follows.

- Lines 260 - 300     Substitutes a variable for the trace number.
- Lines 320 - 460     Substitutes variables for the on/off status of each trace display, measurement parameter, trace display format, and Y-axis display format. In addition, when the measurement parameter is a phase (Trace 2), substitutes variables for the expanded phase display and the phase display format display unit.
- Lines 480 - 520     Substitutes variables for the sweep-related parameter values (sweep parameter/type, sweep range, number of measurement points, and sweep direction).
- Lines 530 - 550     Substitutes variables for the average-related parameter values (sweep averaging and point averaging).
- Lines 560 - 570     Substitutes variables for the auto/manual setting of the sweep time and sweep delay time.
- Lines 580 - 590     Substitutes variables for the oscillator level-related parameters.
- Lines 600 - 610     Substitutes variables for the dc bias-related parameter values.
- Lines 630 - 680     Substitutes variables for the on/off status of the list display of the measurement screen and the object of the display trace (data trace/memory trace).
- Lines 690 - 730     Substitutes variables for the display scale-related parameter values.
- Line 750             Resets the E4991A.
- Line 790             Sets the E4991A to the impedance measurement mode.
- Lines 810 - 950     Sets the measurement parameters for Traces 1, 2, and 4, the trace display format, and the Y-axis display format. In addition, for Trace 2, sets the expanded phase display, as well as the display units of the phase display format.
- Lines 970 - 980     Turns off the Traces 3 and 5.
- Line 1020            Sets the sweep parameter (type).
- Lines 1040 - 1050   Sets the sweep range for the frequency sweep range.
- Lines 1070 - 1130   Sets the measurement point, sweep direction, Sweep averaging function on/off status, averaging factor, point averaging function on/off status, auto/manual setting of the sweep time, and sweep delay time.
- Lines 1170 - 1200   Selects the fixed mode of oscillator current mode and sets the oscillator current level. Next, sets the voltage level in the dc bias fixed mode and sets the maximum value of the dc bias current limit.
- Lines 1240 - 1410   Sets the display scales of Traces 1, 2, and 4.
- Line 1450            Turns on the dc bias output.
- Line 1510            Stops the execution of the macro.

## Setting Measurement Conditions

### Example program for setting the measuring conditions

#### Example 3-2

#### Setting measuring conditions (macro)

```
10      Sub Main()
20          Dim trc1 As Integer, trc2 As Integer, trc3 As Integer
30          Dim trc4 As Integer, trc5 As Integer
40          Dim nop As Integer, sweep_avg_coun As Integer
50          Dim start_freq As Double, stop_freq As Double, sweep_delay
As Double
60          Dim sour_curr As Double, dc_bias_v As Double,
dc_bias_i_lim As Double
70          Dim full_scale1 As Double, full_scale2 As Double,
full_scale4 As Double
80          Dim ref_val1 As Double, ref_val2 As Double, ref_val4 As
Double
90          Dim ref_pos1 As Double, ref_pos2 As Double, ref_pos4 As
Double
100         Dim top_scale1 As Double, top_scale2 As Double, top_scale4
As Double
110         Dim bottom_scale1 As Double, bottom_scale2 As Double,
bottom_scale4 As Double
120         Dim trac1 As String, trac2 As String, trac3 As String
130         Dim trac4 As String, trac5 As String
140         Dim m_para1 As String, m_para2 As String, m_para4 As
String
150         Dim disp_form1 As String, disp_form2 As String, disp_form4
As String
160         Dim disp_y_spac1 As String, disp_y_spac2 As String,
disp_y_spac4 As String
170         Dim phase_unit1 As String, phase_unit2 As String,
phase_unit4 As String
180         Dim phase_exp1 As String, phase_exp2 As String, phase_exp4
As String
190         Dim sweep_type As String, sweep_dir As String
200         Dim sweep_avg As String, point_avg As String
210         Dim sweep_t_auto As String, sour_curr_mode As String
220         Dim list_page1 As String, list_page2 As String, list_page4
As String
230         Dim disp_trac1 As String, disp_trac2 As String, disp_trac4
As String
240         Dim buff As String
250
260         trc1 = 1
270         trc2 = 2
280         trc3 = 3
290         trc4 = 4
300         trc5 = 5
310
320         trac1 = "ON"
330         trac2 = "ON"
340         trac3 = "OFF"
350         trac4 = "ON"
360         trac5 = "OFF"
370         m_para1 = "Z"
380         m_para2 = "ZPH"
390         m_para4 = "RC"
400         disp_form1 = "RECT"
410         disp_form2 = "RECT"
```



## Setting Measurement Conditions

### Example program for setting the measuring conditions

```
420     disp_form4 = "SMIT"
430     disp_y_spac1 = "LOG"
440     disp_y_spac2 = "LIN"
450     phase_unit2 = "DEG"
460     phase_exp2 = "ON"
470
480     sweep_type = "LOG"
490     start_freq = 100000000#
500     stop_freq = 3000000000#
510     nop = 201
520     sweep_dir = "UP"
530     sweep_avg_coun = 16
540     sweep_avg = "ON"
550     point_avg = "ON"
560     sweep_t_auto = "ON"
570     sweep_delay = 0
580     sour_curr_mode = "FIX"
590     sour_curr = 0.001
600     dc_bias_v = 15
610     dc_bias_i_lim = 0.01
620
630     list_page1 = "OFF"
640     list_page2 = "OFF"
650     list_page4 = "OFF"
660     disp_trac1 = "DATA"
670     disp_trac2 = "DATA"
680     disp_trac4 = "DATA"
690     top_scale1 = 100
700     bottom_scale1 = 0.1
710     full_scale2 = 500
720     ref_val2 = 0
730     ref = pos2 = 50
740
750     SCPI.Output "SYST:PRES"
760
770     ' Measurement Mode & Parameter & Disp Format Setting
780
790     SCPI.Output "MODE IMP"
800
810     SCPI.Output "DISP:TRAC" & CStr(trc1) & " " & trac1
820     SCPI.Output "CALC" & CStr(trc1) & ":FORM " & m_para1
830     SCPI.Output "DISP:TRAC" & CStr(trc1) & ":GRAT:FORM " &
disp_form1
840     SCPI.Output "DISP:TRAC" & CStr(trc1) & ":Y:SPAC " &
disp_y_spac1
850
860     SCPI.Output "DISP:TRAC" & CStr(trc2) & " " & trac2
870     SCPI.Output "CALC" & CStr(trc2) & ":FORM " & m_para2
880     SCPI.Output "DISP:TRAC" & CStr(trc2) & ":GRAT:FORM " &
disp_form2
890     SCPI.Output "DISP:TRAC" & CStr(trc2) & ":Y:SPAC " &
disp_y_spac2
900     SCPI.Output "CALC" & CStr(trc2) & ":FORM:UNIT:ANGL " &
phase_unit2
910     SCPI.Output "CALC" & CStr(trc2) & ":FORM:PAR:EPH " &
phase_exp2
920
930     SCPI.Output "DISP:TRAC" & CStr(trc4) & " " & trac4
```

## Setting Measurement Conditions

### Example program for setting the measuring conditions

```
940      SCPI.Output "CALC" & CStr(trc4) & ":FORM " & m_para4
950      SCPI.Output "DISP:TRAC" & CStr(trc4) & ":GRAT:FORM " &
disp_form4
960
970      SCPI.Output "DISP:TRAC" & CStr(trc3) & " " & trac3
980      SCPI.Output "DISP:TRAC" & CStr(trc5) & " " & trac5
990
1000     ' Sweep & Average Setting
1010
1020     SCPI.Output "SWE:TYPE " & sweep_type
1030
1040     SCPI.Output "FREQ:STAR " & CStr(start_freq)
1050     SCPI.Output "FREQ:STOP " & CStr(stop_freq)
1060
1070     SCPI.Output "SWE:POIN " & CStr(nop)
1080     SCPI.Output "SWE:DIR " & sweep_dir
1090     SCPI.Output "CALC:AVER:COUN " & CStr(sweep_avg_coun)
1100     SCPI.Output "CALC:AVER " & sweep_avg
1110     SCPI.Output "AVER " & point_avg
1120     SCPI.Output "SWE:TIME:AUTO " & sweep_t_auto
1130     SCPI.Output "SWE:DWEL1 " & CStr(sweep_delay)
1140
1150     ' Source Setting
1160
1170     SCPI.Output "SOUR:CURR:MODE " & sour_curr_mode
1180     SCPI.Output "SOUR:CURR " & CStr(sour_curr)
1190     SCPI.Output "SOUR:VOLT:OFFS " & CStr(dc_bias_v)
1200     SCPI.Output "SOUR:CURR:LIM:OFFS " & CStr(dc_bias_i_lim)
1210     '
1220     ' Trace1 Setting
1230     '
1240     SCPI.Output "DISP:TRAC" & CStr(trc1) & ":TEXT " &
list_page1
1250
1260     SCPI.Output "CALC" & CStr(trc1) & ":MATH:FUNC " &
disp_trac1
1270     SCPI.Output "DISP:TRAC" & CStr(trc1) & ":Y:TOP " &
CStr(top_scale1)
1280     SCPI.Output "DISP:TRAC" & CStr(trc1) & ":Y:BOTT " &
CStr(bottom_scale1)
1290
1300     ' Trace2 Setting
1310
1320     SCPI.Output "DISP:TRAC" & CStr(trc2) & ":TEXT " &
list_page2
1330     SCPI.Output "CALC" & CStr(trc2) & ":MATH:FUNC " &
disp_trac2
1340     SCPI.Output "DISP:TRAC" & CStr(trc2) & ":Y:FULL " &
CStr(full_scale2)
1350     SCPI.Output "DISP:TRAC" & CStr(trc2) & ":Y:RLEV " &
CStr(ref_val2)
1360     SCPI.Output "DISP:TRAC" & CStr(trc2) & ":Y:RPOS " &
CStr(ref_pos2)
1370
1380     ' Trace4 Setting
1390
1400     SCPI.Output "DISP:TRAC" & CStr(trc4) & ":TEXT " &
list_page4
```

## Setting Measurement Conditions

### Example program for setting the measuring conditions

```
1410     SCPI.Output "CALC" & CStr(trc4) & ":MATH:FUNC " &  
disp_trac4  
1420  
1430     ' DC Bias ON  
1440  
1450     SCPI.Output "SOUR:VOLT:OFFS:STAT ON"  
1460  
1470     buff = SCPI.Query("*OPC?")  
1480  
1490     MsgBox ("Measurement Condition Setup Complete")  
1500  
1510     End  
1520  
1530 End Sub
```

---

## Combination of Several Sweep Conditions (Segment Sweep)

The Agilent E4991A allows you to set combinations of up to 16 segments, each with its own sweep conditions, to perform segment sweep. A segment sweep table must be created before segment sweep can be performed.

### Create/Edit Segment Sweep Table

The segment sweep table can be created or edited in two ways: specifying each segment parameter individually or specifying parameters collectively.

### Display Segment Sweep Table

Use the following GPIB command to display the sweep conditions on the segment sweep table.

- **DISP:TEXT{1-3}:SET** on page 356

### Create Segments and Read Total Number of Segments

To create a segment, use the following GPIB command to create the specified number of segments in the segment sweep table to make them available for editing. This command clears the existing segments and creates new segments. When this command is used in the query format, the total number of segments contained in the table is read.

- **SEGM:COUN** on page 397

### Delete All Segments

Use the following GPIB command to delete all of the segments in the segment sweep table.

- **SEGM:DEL:ALL** on page 406

### Select Oscillator Level Unit

Use the one of the following GPIB commands to select the unit (current/voltage/power) in which the oscillator level is set when the segment sweep table is created.

Oscillator level	GPIB command
Set in current	<b>SEGM:CURR:STAT</b> on page 402
Set in voltage	<b>SEGM:VOLT:STAT</b> on page 418
Set in power (dBm)	<b>SEGM:POW:STAT</b> on page 412

### Select DC Bias Output Mode (DC Bias Function)

When the dc bias function is used, use one of the following GPIB commands to select whether the dc bias output level is set to the fixed voltage or fixed current source mode when the segment sweep table is created.

Output mode	GPIB command
Fixed current source mode	<b>SEGM:CURR:OFFS:STAT</b> on page 399
Fixed voltage source mode	<b>SEGM:VOLT:OFFS:STAT</b> on page 417

### Set Each Segment Parameter Individually

Use the following GPIB command to set each parameter in the segment sweep table.

**Table 3-4 Set of Parameters in Segment Sweep Table**

Parameter		GPIB command
Frequency sweep range	Start value	<b>SEGM{1-16}:FREQ:STAR</b> on page 409
	Stop value	<b>SEGM{1-16}:FREQ:STOP</b> on page 410
	Center value	<b>SEGM{1-16}:FREQ:CENT</b> on page 407
	Span value	<b>SEGM{1-16}:FREQ:SPAN</b> on page 408
Number of measurement points <sup>*1</sup>		<b>SEGM{1-16}:SWE:POIN</b> on page 413
Point averaging factor		<b>SEGM{1-16}:AVER:COUN</b> on page 396
Oscillator level	Current value	<b>SEGM{1-16}:CURR</b> on page 398
	Voltage value	<b>SEGM{1-16}:VOLT</b> on page 414
	Power (dBm) value	<b>SEGM{1-16}:POW</b> on page 411
dc bias (Fixed voltage source)	Output voltage level	<b>SEGM{1-16}:VOLT:OFFS</b> on page 416
	Current limit maximum value	<b>SEGM{1-16}:CURR:LIM</b> on page 400
dc bias (Fixed current source)	Output current level	<b>SEGM{1-16}:CURR:OFFS</b> on page 401
	Voltage limit maximum value	<b>SEGM{1-16}:VOLT:LIM</b> on page 415

\*1. The total number of measurement points for each segment cannot exceed 801. The **SWE:POIN** command can be used to read the total number of measurement points for each segment.

### Set Segment Parameters Collectively

Use the following GPIB command to collectively set all of the parameters required to create the segment sweep table for each segment.

- **SEGM{1-16}:DATA** on page 403

The following GPIB command can be used to apply the same parameter values to all of the segments on the segment sweep table.

- **SEGM:DATA:ALL** on page 405

### Turn On/Off DC Bias Output (DC Bias Function)

If dc bias is applied to the DUT during segment sweep, use the following GPIB command to turn on or off the dc bias output. When the output is switched from off to on, sweep is automatically set to the hold mode.

Use the following GPIB command to turn on or off the dc bias output in the fixed voltage source mode.

- **SOUR:VOLT:OFFS:STAT** on page 484

Use the following GPIB command to turn on or off the dc bias output in the fixed current source mode.

- **SOUR:CURR:OFFS:STAT** on page 465

## Example program for setting the segment sweep conditions

An example program for setting the segment sweep conditions is described below. This program sets the segment sweep conditions as follows after resetting the E4991A. When the setting is complete, a completion message is displayed.

Segment sweep table setting item	Segment 1	Segment 2	Segment 3
Start frequency	1 MHz	100 MHz	1 GHz
Stop frequency	100 MHz	1 GHz	3 GHz
Number of measurement points	101	101	51
Oscillator output level	100 mV	100 mV	100 mV
dc bias output voltage level	10 V	10 V	10 V
dc bias current limit maximum value	10 mA	10 mA	10 mA
Number of point averaging	32	4	4
Sweep type	Segment sweep		
Delay time at each segment	0.1 sec		
X-axis span display format	Each segment		

## Example program using HTBasic

The program shown in Example 3-3 is saved under the filename `segm_set.htb` on the sample programs disk. The details of this program are explained as follows.

- Line 60            Sets the GPIB address of the E4991A.
- Lines 80 - 100    Substitutes a variable for the total number of segments to be created. In addition, substitutes variables for the oscillator level and the setting units of the dc bias. However, when the dc bias function is not installed in the E4991A, enters "OFF" for the variable `Dcbias_units$`.
- Line 140           Resets the E4991A.
- Lines 150 - 180   Creates a segment in the segment sweep table and displays the table. In addition, sets the setting units of the oscillator level.
- Line 200           Branches the program for either the condition in which the dc bias function is installed or that in which it is not installed in the E4991A.
- Lines 250 - 270   Declares the parameters (start/stop frequency, number of measurement points, point averaging factor, oscillator output level, dc bias output voltage level, and dc bias current limit maximum value) that are necessary for setting the segment sweep table.
- Line 290           Sets the dc bias setting units for creating the segment sweep table.
- Lines 300 - 340   When the dc bias function is installed, reads the setting parameters necessary for creating the segment sweep table while looping for the total number of segments in the section and then provides the setting parameters to the sub-program.
- Lines 400 - 480   When the dc bias function is not installed, calls the sub-program to create the segment sweep table in this section.

## Example program for setting the segment sweep conditions

- Lines 520 - 540 Reads out the total number of segments created and indicates that the creation of the segment sweep table is complete.
- Line 600 -760 When the dc bias function is installed, this sub program sets the start/stop frequency, number of measurement points, point averaging factor, and the oscillator output level. Sets the necessary setting parameters for each dc bias mode (fixed voltage source/fixed current source).
- Lines 800 - 880 When the dc bias function is not installed, this sub-program sets the start/stop frequency, number of measurement points, point averaging factor, and oscillator output level for non-dc bias setting parameters.

## Example 3-3

## Setting segment sweep conditions (HTBasic)

```

10     INTEGER No_of_segment,Nop,Point_avg,Segm_no
20     REAL Start_f,Stop_f,Osc,Dcbias,Dcbias_lim
30     DIM Osc_unit$(7),Dcbias_unit$(6)
40     !
50     CLEAR SCREEN
60     ASSIGN @Agte4991a TO 717
70     !
80     No_of_segment=3
90     Osc_unit$="VOLT"                ! CURR/VOLT/POW
100    Dcbias_unit$="VOLT"            ! CURR/VOLT/OFF
110    !
120    ! Initial Setting
130    !
140    OUTPUT @Agte4991a;"SYST:PRES"
150    OUTPUT @Agte4991a;"SEGM:COUN "&VAL$(No_of_segment)
160    OUTPUT @Agte4991a;"DISP:TEXT:STAT ON"
170    OUTPUT @Agte4991a;"DISP:TEXT1:SET"
180    OUTPUT @Agte4991a;"SEGM:"&Osc_unit$&":STAT ON"
190    !
200    IF Dcbias_unit$="CURR" OR Dcbias_unit$="VOLT" THEN
210    !
220    ! Entry Segment Data with DC Bias
230    !
240    Data_w_bias:!
250        DATA 1E6, 100E6, 101, 32, 0.1, 10, 0.01
260        DATA 100E6, 1E9, 101, 4, 0.1, 10, 0.01
270        DATA 1E9, 3E9, 51, 4, 0.1, 10, 0.01
280        !
290        OUTPUT @Agte4991a;"SEGM:"&Dcbias_unit$&":OFFS:STAT ON"
300        RESTORE Data_w_bias
310        FOR Segm_no=1 TO No_of_segment
320            READ
Start_f,Stop_f,Nop,Point_avg,Osc,Dcbias,Dcbias_lim
330            CALL
Segm_tbl_bias(@Agte4991a,Segm_no,Start_f,Stop_f,Nop,Point_avg,Osc_u
nit$,Osc,Dcbias_unit$,Dcbias,Dcbias_lim)
340            NEXT Segm_no
350        ELSE
360        !
370        ! Entry Segment Data w/o DC Bias
380        !
390    Data_wo_bias:!
400        DATA 1E6, 100E6, 101, 32, 0.1

```

## Setting Measurement Conditions

### Example program for setting the segment sweep conditions

```
410      DATA 100E6,    1E9,  101,  4,  0.1
420      DATA  1E9,    3E9,  51,  4,  0.1
430      !
440      RESTORE Data_wo_bias
450      FOR Segm_no=1 TO No_of_segment
460          READ Start_f,Stop_f,Nop,Point_avg,Osc
470          CALL
Segm_tbl(@Agte4991a,Segm_no,Start_f,Stop_f,Nop,Point_avg,Osc_unit$,
Osc)
480      NEXT Segm_no
490      END IF
500      !
510      Finish_entry:!
520      OUTPUT @Agte4991a;"SEGM:COUN?"
530      ENTER @Agte4991a;Seg_count
540      PRINT "Preparation of Segment Table finished. (No. of
Segmnet: "&VAL$(Seg_count)&") "
550      !
560      END
570      !
580      ! Segment Table Setting with DC Bias
590      !
600      SUB Segm_tbl_bias(@Agte4991a,INTEGER Seg_no,REAL
Start_f,Stop_f,INTEGER Nop,Point_avg,Osc_unit$,REAL
Osc,Dcbias_unit$,REAL Dcbias,Dcbias_lim)
610      !
620          OUTPUT @Agte4991a;"SEGM"&VAL$(Seg_no)&":FREQ:STAR
"&VAL$(Start_f)
630          OUTPUT @Agte4991a;"SEGM"&VAL$(Seg_no)&":FREQ:STOP
"&VAL$(Stop_f)
640          OUTPUT @Agte4991a;"SEGM"&VAL$(Seg_no)&":SWE:POIN
"&VAL$(Nop)
650          OUTPUT @Agte4991a;"SEGM"&VAL$(Seg_no)&":AVER:COUN
"&VAL$(Point_avg)
660          OUTPUT @Agte4991a;"SEGM"&VAL$(Seg_no)&":&Osc_unit$&
"&VAL$(Osc)
670          SELECT Dcbias_unit$
680          CASE "VOLT"
690              OUTPUT @Agte4991a;"SEGM"&VAL$(Seg_no)&":VOLT:OFFS
"&VAL$(Dcbias)
700              OUTPUT @Agte4991a;"SEGM"&VAL$(Seg_no)&":CURR:LIM
"&VAL$(Dcbias_lim)
710              CASE "CURR"
720              OUTPUT @Agte4991a;"SEGM"&VAL$(Seg_no)&":CURR:OFFS
"&VAL$(Dcbias)
730              OUTPUT @Agte4991a;"SEGM"&VAL$(Seg_no)&":VOLT:LIM
"&VAL$(Dcbias_lim)
740          END SELECT
750          !
760      SUBEND
770      !
780      ! Segment Table Setting w/o DC Bias
790      !
800      SUB Segm_tbl(@Agte4991a,INTEGER Seg_no,REAL
Start_f,Stop_f,INTEGER Nop,Point_avg,Osc_unit$,REAL Osc)
810      !
820          OUTPUT @Agte4991a;"SEGM"&VAL$(Seg_no)&":FREQ:STAR
"&VAL$(Start_f)
```



## Setting Measurement Conditions

### Example program for setting the segment sweep conditions

```
830      OUTPUT @Agte4991a;"SEGM"&VAL$(Seg_no) &":FREQ:STOP
"&VAL$(Stop_f)
840      OUTPUT @Agte4991a;"SEGM"&VAL$(Seg_no) &":SWE:POIN
"&VAL$(Nop)
850      OUTPUT @Agte4991a;"SEGM"&VAL$(Seg_no) &":AVER:COUN
"&VAL$(Point_avg)
860      OUTPUT @Agte4991a;"SEGM"&VAL$(Seg_no) &":&Osc_unit$&"
"&VAL$(Osc)
870      !
880      SUBEND
```

### Example program using macro (E4991A VBA)

The program shown in Example 3-4 is saved under the filename `segm_set.bas` on the sample programs disk. The details of this program are explained as follows.

Lines 90 - 110	Substitutes a variable for the total number of segments to be created. In addition, substitutes variables for the oscillator level and the setting units of the dc bias. However, when the dc bias function is not installed in the E4991A, enters "OFF" for the variable <code>Dcbias_units\$</code> .
Lines 130 - 330	Substitutes a variable for the parameters (start/stop frequency, number of measurement points, point averaging factor, oscillator output level, dc bias output voltage level, and dc bias current limit maximum value) that are necessary for setting the segment sweep table.
Line 370	Resets the E4991A.
Lines 380 - 400	Creates a segment in the segment sweep table and displays the segment table. In addition, sets the setting units of the oscillator level.
Line 420	Branches the program for either the condition in which the dc bias function is installed or that in which it is not installed in the E4991A.
Line 430	Sets the dc bias setting units for creating the segment sweep table.
Lines 440 - 460	When the dc bias function is installed, reads the setting parameters necessary for creating the segment sweep table while looping for the total number of the segments in the section and then provides the setting parameters to the sub-program.
Lines 480 - 480	When the dc bias function is not installed, reads the setting parameters necessary for creating the segment sweep table while looping for the total number of the segments in section and then provides the setting parameters to the sub-program.
Lines 530 - 550	Reads out the total number of segments created and displays a message reading "Preparation of Segment Table Finished."
Line 570	Stops the execution of the macro.
Line 610 -770	When the dc bias function is installed, this sub-program ( <code>segm_tbl_bias</code> ) sets the start/stop frequency, number of measurement points, point averaging factor, and the oscillator output level. Sets the necessary setting parameters for each dc bias mode (fixed voltage source/fixed current source).
Lines 790 - 870	When the dc bias function is not installed, this sub-program ( <code>segm_tbl</code> ) sets the start/stop frequency, number of measurement points, point averaging factor, and oscillator output level except for dc bias setting parameters.

#### Example 3-4

#### Setting segment sweep conditions (macro)

```
10 Sub Main()  
20 Dim no_of_segment As Integer, segm_no As Integer  
30 Dim nop(3) As Integer, point_avg(3) As Integer  
40 Dim start_f(3) As Double, stop_f(3) As Double  
50 Dim osc(3) As Double, dcbias(3) As Double, dcbias_lim(3)  
As Double  
60 Dim segm_count As Integer
```

## Setting Measurement Conditions

### Example program for setting the segment sweep conditions

```
70     Dim osc_unit As String, dcbias_unit As String
80
90     no_of_segment = 3
100    osc_unit = "VOLT"
110    dcbias_unit = "CURR"
120
130    start_f(1) = 1000000#
140    stop_f(1) = 100000000#
150    nop(1) = 101
160    point_avg(1) = 32
170    osc(1) = 0.1
180    dcbias(1) = 10
190    dcbias_lim(1) = 0.01
200    start_f(2) = 100000000#
210    stop_f(2) = 1000000000#
220    nop(2) = 101
230    point_avg(2) = 4
240    osc(2) = 0.1
250    dcbias(2) = 10
260    dcbias_lim(2) = 0.01
270    start_f(3) = 1000000000#
280    stop_f(3) = 3000000000#
290    nop(3) = 51
300    point_avg(3) = 4
310    osc(3) = 0.1
320    dcbias(3) = 10
330    dcbias_lim(3) = 0.01
340
350    ' Initial Setting
360
370    SCPI.Output "SYST:PRES"
380    SCPI.Output "SEGM:COUN " & CStr(no_of_segment)
390    SCPI.Output "DISP:TEXT:STAT ON"
400    SCPI.Output "SEGM:" & osc_unit & ":STAT ON"
410
420    If dcbias_unit = "VOLT" Or dcbias_unit = "CURR" Then
430        SCPI.Output "SEGM:" & dcbias_unit & ":OFFS:STAT ON"
440        For segm_no = 1 To no_of_segment
450            Call segm_tbl_bias(segm_no, start_f(segm_no),
stop_f(segm_no), nop(segm_no), point_avg(segm_no), osc_unit,
osc(segm_no), dcbias_unit, dcbias(segm_no), dcbias_lim(segm_no))
460        Next segm_no
470        ElseIf dcbias_unit = "OFF" Then
480            For segm_no = 1 To no_of_segment
490                Call segm_tbl(segm_no, start_f(segm_no),
stop_f(segm_no), nop(segm_no), point_avg(segm_no), osc_unit,
osc(segm_no))
500            Next segm_no
510        End If
520
530        segm_coun = SCPI.Query("SEGM:COUN?")
540        SCPI.Output "DISP:TEXT1:SET"
550        MsgBox ("Preparation of Segment Table Finished. (No. of
Segment: " & CStr(segm_coun)) & ")")
560
570    End
580
590    End Sub
```

## Setting Measurement Conditions

### Example program for setting the segment sweep conditions

```
600
610     Sub segm_tbl_bias(seg_m_no As Integer, start_f, stop_f As
Double, nop, point_avg As Integer, osc_unit As String, osc As
Double, dcbias_unit As String, dcbias, dcbias_lim As Double)
620
630         SCPI.Output "SEGM" & CStr(seg_m_no) & ":FREQ:STAR " &
CStr(start_f)
640         SCPI.Output "SEGM" & CStr(seg_m_no) & ":FREQ:STOP " &
CStr(stop_f)
650         SCPI.Output "SEGM" & CStr(seg_m_no) & ":SWE:POIN " &
CStr(nop)
660         SCPI.Output "SEGM" & CStr(seg_m_no) & ":AVER:COUN " &
CStr(point_avg)
670         SCPI.Output "SEGM" & CStr(seg_m_no) & ":" & osc_unit & " "
& CStr(osc)
680         Select Case dcbias_unit
690             Case "VOLT"
700                 SCPI.Output "SEGM" & CStr(seg_m_no) & ":VOLT:OFFS " &
CStr(dcbias)
710                 SCPI.Output "SEGM" & CStr(seg_m_no) & ":CURR:LIM " &
CStr(dcbias_lim)
720             Case "CURR"
730                 SCPI.Output "SEGM" & CStr(seg_m_no) & ":CURR:OFFS " &
CStr(dcbias)
740                 SCPI.Output "SEGM" & CStr(seg_m_no) & ":VOLT:LIM " &
CStr(dcbias_lim)
750         End Select
760
770     End Sub
780
790     Sub segm_tbl(seg_m_no As Integer, start_f, stop_f As Double,
nop, point_avg As Integer, osc_unit As String, osc As Double)
800
810         SCPI.Output "SEGM" & CStr(seg_m_no) & ":FREQ:STAR " &
CStr(start_f)
820         SCPI.Output "SEGM" & CStr(seg_m_no) & ":FREQ:STOP " &
CStr(stop_f)
830         SCPI.Output "SEGM" & CStr(seg_m_no) & ":SWE:POIN " &
CStr(nop)
840         SCPI.Output "SEGM" & CStr(seg_m_no) & ":AVER:COUN " &
CStr(point_avg)
850         SCPI.Output "SEGM" & CStr(seg_m_no) & ":" & osc_unit & " "
& CStr(osc)
860
870     End Sub
```

---

## **4 Preparation for Accurate Measurement**

This chapter explains how to perform calibration as well as electrical length and fixture compensation for the Agilent E4991A.

## Calibration

To assure accurate measurements, calibration must be performed on the DUT port on the test head. In the Dielectric Material measurement mode, calibration should be performed on the surface of the test fixture that makes contact with the DUT. The following section explains how to perform calibration.

### Define Calibration Kit

#### Selection

Use the following GPIB command to select whether the 7-mm calibration kit included with the E4991A or a user-defined calibration kit is used for calibration.

- **SENS:CORR1:CKIT** on page 420

#### How to Enter Standard Values for User-Defined Calibration Kit

When a user-defined calibration kit is used to perform calibration, use the following GPIB command to select whether the Open/Short/Load standard values are set to a single value or different values for each frequency.

- **SENS:CORR1:CKIT:LIST** on page 421

#### Standard Value for User-Defined Calibration Kit (Single Value)

Use the following GPIB commands to define the Open/Short/Load standard values as a single value common to each frequency.

Standard	Parameter	GPIB command
Open	Conductance value (G)	<b>SENS:CORR1:CKIT:STAN1:G</b> on page 423
	Capacitance value (C)	<b>SENS:CORR1:CKIT:STAN1:C</b> on page 422
Short	Resistance value (R)	<b>SENS:CORR1:CKIT:STAN2:R</b> on page 429
	Inductance value (L)	<b>SENS:CORR1:CKIT:STAN2:L</b> on page 426
Load	Resistance value (R)	<b>SENS:CORR1:CKIT:STAN3:R</b> on page 433
	Inductance value (L)	<b>SENS:CORR1:CKIT:STAN3:L</b> on page 430

#### Standard Value Array for User-Defined Calibration Kit (Frequency)

By defining the Open/Short/Load standard values of the calibration kit as an array for each frequency, errors due to frequency characteristics of the Open/Short/Load standard can be removed. Use the following GPIB commands to define standard values as an array for each frequency.

Standard	Parameter	GPIB command
Open	Conductance value (G)	<b>SENS:CORR1:CKIT:STAN1:LIST:G</b> on page 425
	Susceptance value (B)	<b>SENS:CORR1:CKIT:STAN1:LIST:B</b> on page 424
Short	Resistance value (R)	<b>SENS:CORR1:CKIT:STAN2:LIST:R</b> on page 427
	Reactance value (X)	<b>SENS:CORR1:CKIT:STAN2:LIST:X</b> on page 428
Load	Resistance value (R)	<b>SENS:CORR1:CKIT:STAN3:LIST:R</b> on page 431
	Reactance value (X)	<b>SENS:CORR1:CKIT:STAN3:LIST:X</b> on page 432

## Define Load Standard Value Used for Measurement of Dielectric Material

### Selection

When performing calibration in the dielectric material measurement mode, use the following GPIB command to select whether the Load standard included with the Agilent 16453A or a user-defined Load standard is used.

- **SENS:CORR1:CKIT** on page 420

### User-Defined Load Standard Value

If the Load standard included with the Agilent 16453A is used, each parameter of the Load standard is set to the E4991A predefined value. When a user-defined Load standard is used to perform calibration, the following GPIB commands must be used to define the parameters for the Load standard.

Standard	Parameter	GPIB command
Load	Relative permittivity	<b>SENS:CORR1:CKIT:STAN7:PRE</b> on page 435
	Dielectric loss factor	<b>SENS:CORR1:CKIT:STAN7:PLF</b> on page 434
	Thickness	<b>SENS:CORR1:CKIT:STAN7:THIC</b> on page 436

## Select Calibration Data Measurement Points

Select calibration data measurement points from the following table. Note that when fixed points are used to measure calibration data, calibration coefficients are calculated through interpolation.

Measurement points	Description
Fixed frequency / fixed power points calibration	Measures calibration data at the predefined fixed frequency points and over the entire oscillator level range.
Fixed frequency / user defined power points calibration	Measures calibration data at the predefined fixed frequency points and at user defined oscillator level.
User defined frequency / user defined power points calibration	Measures calibration data at user defined frequency points and at user defined oscillator level.

Use the following GPIB command to select calibration data measurement points.

- **SENS:CORR1:COLL:FPO** on page 438

### NOTE

Calibration data measurement points are set in coordination with fixture compensation data measurement points. To select fixture compensation data measurement points, use the **SENS:CORR2:COLL:FPO** command.

## Measure Calibration Data

### Perform Measurement

Use the following GPIB command to measure Open/Short/Load and, if necessary, Low-loss capacitor calibration data used to calculate calibration coefficients.

- **SENS:CORR1:COLL** on page 437

---

**NOTE** If a trigger source is set to an external trigger, execution of the above command does not start calibration data measurement. After executing this command, prepare a trigger.

---

---

**NOTE** In the dielectric material measurement mode, an Open/Short/Load standard is used on the DUT-connect surface of the test fixture to measure calibration data. If the dielectric material measurement mode is selected, the test fixture is automatically set to Agilent 16543A, eliminating the need to select a test fixture in advance. In addition, fixture compensation is disabled in this mode.

---

Completion of calibration data measurement can be detected by monitoring when the status bit 0 of the Operation Status Event Register changes. Use one of the following GPIB commands to monitor the status bit.

- **STAT:OPER:PTR** on page 492
- **STAT:OPER:NTR** on page 491
- **STAT:OPER:ENAB** on page 490
- **\*SRE** on page 283

### Enable Calibration

After measuring calibration data, use the following GPIB command to calculate calibration coefficients. This GPIB command automatically enables calibration.

- **SENS:CORR1:COLL:SAVE** on page 439

---

**NOTE** Calculation of calibration coefficients requires all of the Open/Short/Load measurement data. If the above command is executed before data measurement is complete, an error occurs and the command is ignored.

---

The following GPIB command can be used to disable the calibration function. However, this command cannot be used to enable calibration.

- **SENS:CORR1** on page 419

---

**NOTE** When the calibration function is disabled, calibration data arrays and calibration coefficient arrays are cleared.

---



## Calibration Data Array/Calibration Coefficient Array

The calibration data array contains Open/Short/Load/Low-loss capacitor measurement data in the complex format. This measurement data is used for calculating calibration coefficients. The calibration coefficient array contains calibration coefficients in the complex format. They are calculated by using the calibration data array.

The calibration data and coefficient arrays can be read. The calibration coefficient array, once read, can be written back again.

### Read Calibration Data Array

For details on how to read the calibration data array, refer to “Read Calibration Data Array” on page 77.

### Read and Write Calibration Coefficient Array

For details on how to read and write the calibration coefficient array, refer to “Read and Write Calibration Coefficient Array” on page 77.

### Clear Calibration Data and Coefficient Arrays

The following GPIB command can be used to clear the calibration data and coefficient arrays and disable the calibration function.

- **SENS:CORR1** on page 419

### Example program for execution of calibration

The example program described below is used to measure each standard of the calibration kit to make the calibration function effective. When a user-defined calibration kit is used, after defining standard values, the calibration function is enabled by measuring each standard for Open, Short, Load, and Low-loss capacitor. Moreover, when the calibration function is enabled, the internally calculated calibration coefficient is saved in the external controller.

### Example program using HTBasic

The program shown in Example 4-1 is saved under the filename cal\_meas.htb on the sample programs disk. The details of this program are explained as follows.

Line 100	Sets the GPIB address.
Lines 140 - 150	Substitutes a variable for the calibration kit type and the obtained calibration data point.
Lines 170 - 180	Sets the calibration kit type and selects the measurement point for calibration.
Line 200	When the user-defined calibration kit is selected, the program branches, and each standard for the calibration kit is defined.
Line 220	Selects a setting that defines each standard value at a common unique value at all frequencies without using the list-setting function in the calibration kit.
Lines 260 - 430	Defines the standard value for Open (G-C), Short (R-L), and Load (R-L) using the value prepared by the user. However, each standard is defined in the sub-program (Inp_data).
Lines 480 - 590	Measures calibration data for Open/Short/Load standards. Measurement of the calibration data, however, is performed in the sub-program (FNCal). If a GPIB error occurs during the calibration data measurement, a value of -1 is returned from the function sub-program, so the calibration is programmed to be halted at that point.
Lines 630 - 690	Chooses whether the Low-loss capacitor is measured. If yes, the measurement is executed.
Lines 730 - 770	Calculates the calibration coefficient and sets on the calibration function. After that, completion of the calibration is indicated.
Lines 810 - 850	Reads the number of points for a sweep, and using this value, resets the range of array variables used when the calibration coefficient is read.
Lines 870 - 990	Reads the six calibration coefficient arrays in ASCII transfer format.
Lines 1010 - 1080	Saves the calibration coefficient array read and then saves it in the external computer in binary format. Then, the completion of read and write operations of the calibration coefficient is displayed.
Lines 1180 - 1190	Prompts connection of the calibration measurement standard specified by the variable Standard\$ and waits for the input of [Y] or [y] after the connection.
Line 1210	Clears the status byte register and operation status event register.

- Lines 1220 - 1230 Sets the bit 0 of the operation status event register at 1 only when the operation status condition register bit 0 transits from 1 to 0 (negative transition).
- Lines 1240 - 1250 Sets bit 0 of the operation status event register as effective and, upon completion of calibration, sets bit 7 of the status byte register as effective.
- Lines 1260 - 1270 Sets the branch for the SRQ interruption and enables SRQ interruption.
- Lines 1280 - 1370 Sends the command for calibration of the standard specified by the variable Standard\$ and measures the calibration data.
- Lines 1380 - 1390 Displays a message indicating measurement that is in progress and waits for the completion of the measurement.
- Lines 1410 - 1570 Checks whether a GPIB error occurred in the E4991A during measurement. If no error occurred, displays a message indicating completion of measurement and returns a value of 0 from the function sub-program. However, if there was an error, an error message and a measurement halt message are displayed and a value of -1 is returned from the function sub-program.
- Lines 1620 - 1630 Prompts input of the standard value of the user-defined calibration kit specified by the variable Mes\$ and waits for the input.
- Lines 1640 - 1670 Displays the input value and waits for input (made by using the [Y/N] keys) on whether it is accurate. If a key other than [Y] or [y] is pressed, it returns to the first line of the input.

**Example 4-1**

**Measurement of data for calibration (HTBasic)**

```

10   DIM Inp_char$(9),Buff$(9),File$(20)
20   DIM Cal_kit$(7),Cal_point$(9)
30   DIM Cal_a1(1:801,1:2),Cal_a2(1:801,1:2)
40   DIM Cal_b1(1:801,1:2),Cal_b2(1:801,1:2)
50   DIM Cal_c1(1:801,1:2),Cal_c2(1:801,1:2)
60   REAL
Open_g,Open_c,Short_r,Short_l,Load_r,Load_l,Load_q,Load_c,Load_d
70   INTEGER Inp_no,Result,Nop_cal,Data_size
80   !
90   CLEAR SCREEN
100  ASSIGN @Agte4991a TO 717
110  !
120  ! Initial Setting
130  !
140  Cal_kit$="DEF"           ! DEF/USER
150  Cal_point$="FIX"       ! FIX/FUS/USER
160  !
170  OUTPUT @Agte4991a;"SENS:CORR1:CKIT "&Cal_kit$
180  OUTPUT @Agte4991a;"SENS:CORR1:COLL:FPO "&Cal_point$
190  !
200  IF Cal_kit$="USER" THEN      ! Entry Value of User Define Std.
210  !
220  OUTPUT @Agte4991a;"SENS:CORR1:CKIT:LIST OFF"
230  !
240  ! Entry Open Std. Value (G-C)
250  !

```

4. Preparation for Accurate Measurement

## Preparation for Accurate Measurement Calibration

```
260     CALL Inp_data("Open(G)",Open_g)
270     CALL Inp_data("Open(C)",Open_c)
280     OUTPUT @Agte4991a;"SENS:CORR1:CKIT:STAN1:G "&VAL$(Open_g)
290     OUTPUT @Agte4991a;"SENS:CORR1:CKIT:STAN1:C "&VAL$(Open_c)
300     !
310     ! Entry Short Std. Value (R-L)
320     !
330     CALL Inp_data("Short(R)",Short_r)
340     CALL Inp_data("Short(L)",Short_l)
350     OUTPUT @Agte4991a;"SENS:CORR1:CKIT:STAN2:R "&VAL$(Short_r)
360     OUTPUT @Agte4991a;"SENS:CORR1:CKIT:STAN2:L "&VAL$(Short_l)
370     !
380     ! Entry Load Std. Value (R-L)
390     !
400     CALL Inp_data("Load(R)",Load_r)
410     CALL Inp_data("Load(L)",Load_l)
420     OUTPUT @Agte4991a;"SENS:CORR1:CKIT:STAN3:R "&VAL$(Load_r)
430     OUTPUT @Agte4991a;"SENS:CORR1:CKIT:STAN3:L "&VAL$(Load_l)
440     END IF
450     !
460     ! Open Data Measurement
470     !
480     Result=FNCal(@Agte4991a,"Open")
490     IF Result<>0 THEN Prog_end
500     !
510     ! Short Data Measurement
520     !
530     Result=FNCal(@Agte4991a,"Short")
540     IF Result<>0 THEN Prog_end
550     !
560     ! Load Data Measurement
570     !
580     Result=FNCal(@Agte4991a,"Load")
590     IF Result<>0 THEN Prog_end
600     !
610     ! Low-Loss Capacitor Data Measurement
620     !
630     PRINT "Do you want to measure Low-Loss Capacitor?"
640     PRINT
650     INPUT "[Y/N]",Inp_char$
660     IF UPC$(Inp_char$)="Y" THEN
670         Result=FNCal(@Agte4991a,"Low-Loss C")
680         IF Result<>0 THEN Prog_end
690     END IF
700     !
710     ! Calibration Done
720     !
730     OUTPUT @Agte4991a;"SENS:CORR1:COLL:SAVE"
740     OUTPUT @Agte4991a;"*OPC?"
750     ENTER @Agte4991a;Buff$
760     PRINT "All Data Measurement Complete"
770     PRINT
780     !
790     ! Calibration Coefficient Array Reading & Saving
800     !
810     OUTPUT @Agte4991a;"SWE:POIN?"
820     ENTER @Agte4991a;Nop_cal
830     REDIM Cal_a1(1:Nop_cal,1:2),Cal_a2(1:Nop_cal,1:2)
```

```

840 REDIM Cal_b1(1:Nop_cal,1:2),Cal_b2(1:Nop_cal,1:2)
850 REDIM Cal_c1(1:Nop_cal,1:2),Cal_c2(1:Nop_cal,1:2)
860 !
870 OUTPUT @Agte4991a;"FORM:DATA ASC"
880 OUTPUT @Agte4991a;"DATA:CCO1?"
890 ENTER @Agte4991a;Cal_a1(*)
900 OUTPUT @Agte4991a;"DATA:CCO2?"
910 ENTER @Agte4991a;Cal_b1(*)
920 OUTPUT @Agte4991a;"DATA:CCO3?"
930 ENTER @Agte4991a;Cal_c1(*)
940 OUTPUT @Agte4991a;"DATA:CCO4?"
950 ENTER @Agte4991a;Cal_a2(*)
960 OUTPUT @Agte4991a;"DATA:CCO5?"
970 ENTER @Agte4991a;Cal_b2(*)
980 OUTPUT @Agte4991a;"DATA:CCO6?"
990 ENTER @Agte4991a;Cal_c2(*)
1000 !
1010 File$="CAL_COEF"
1020 Data_size=(Nop_cal*2*6)*8
1030 CREATE File$,Data_size
1040 ASSIGN @File TO File$;FORMAT OFF
1050 OUTPUT
@File;Cal_a1(*),Cal_b1(*),Cal_c1(*),Cal_a2(*),Cal_b2(*),Cal_c2(*)
1060 ASSIGN @File TO *
1070 !
1080 PRINT "Calibration Coefficient File Saving Complete"
1090 !
1100 Prog_end: END
1110 !
1120 ! Calibration Data Measurement Function
1130 !
1140 DEF FNCal(@Agte4991a,Standard$)
1150 DIM Inp_char$(9),Err_mes$(50)
1160 INTEGER Err_no
1170 !
1180 PRINT "Connect "&Standard$&" Standard to the DUT Port."
1190 INPUT "OK? [Y/N]",Inp_char$
1200 IF UPC$(Inp_char$)="Y" THEN
1210 OUTPUT @Agte4991a;"*CLS"
1220 OUTPUT @Agte4991a;"STAT:OPER:PTR 0"
1230 OUTPUT @Agte4991a;"STAT:OPER:NTR 1"
1240 OUTPUT @Agte4991a;"STAT:OPER:ENAB 1"
1250 OUTPUT @Agte4991a;"*SRE 128"
1260 ON INTR 7 GOTO Meas_end
1270 ENABLE INTR 7;2
1280 SELECT Standard$
1290 CASE "Open"
1300 OUTPUT @Agte4991a;"SENS:CORR1:COLL STAN1"
1310 CASE "Short"
1320 OUTPUT @Agte4991a;"SENS:CORR1:COLL STAN2"
1330 CASE "Load"
1340 OUTPUT @Agte4991a;"SENS:CORR1:COLL STAN3"
1350 CASE "Low-Loss C"
1360 OUTPUT @Agte4991a;"SENS:CORR1:COLL STAN4"
1370 END SELECT
1380 DISP "Now measuring..."
1390 Meas_wait: GOTO Meas_wait
1400 Meas_end: DISP

```

## Preparation for Accurate Measurement Calibration

```
1410     OUTPUT @Agte4991a;"SYST:ERR?"
1420     ENTER @Agte4991a;Err_no,Err_mes$
1430     IF Err_no=0 THEN
1440         PRINT Standard$&" data measurement completion"
1450         PRINT
1460         RETURN 0
1470     ELSE
1480         PRINT "Error: "&Err_mes$
1490         PRINT "Program interruption"
1500         PRINT
1510         RETURN -1
1520     END IF
1530 ELSE
1540     PRINT "Program interruption"
1550     PRINT
1560     RETURN -1
1570 END IF
1580 FNEND
1590 !
1600 SUB Inp_data(Mes$,Inp_val)
1610     DIM Inp_char$(9)
1620     PRINT "Input "&Mes$
1630 Inp_start: INPUT "Value?",Inp_val
1640     PRINT Mes$&" Value: ";Inp_val
1650     PRINT
1660     INPUT "OK? [Y/N]",Inp_char$
1670     IF UPC$(Inp_char$)<>"Y" THEN Inp_start
1680 SUBEND
```

**Example program using macro (E4991A VBA)**

The program shown in Example 4-2 is saved under the filename cal\_meas.bas on the sample programs disk. The details of this program are explained as follows.

- Lines 130 - 140     Substitutes a variable for the calibration kit type and the obtained calibration data point.
- Lines 160 - 170     Sets the calibration kit type and selects the measurement point for the calibration.
- Line 190             When the user-defined calibration kit is selected (defines variable of cal\_fix to USER), the program branches, and each standard for the calibration kit is defined.
- Line 210             Selects a setting where each calibration standard value is defined without using the list setting function.
- Lines 230 - 360     Defines the standard values for Open (G-C), Short (R-L), and Load (R-L) using the values prepared by the user. Defining each standard value is performed in the procedure (Inp\_data).
- Lines 400 - 470     Measures calibration data for Open/Short/Load standards. Measurement of the calibration data is performed in the function program (Cal). When measurement is aborted during the calibration, the function program returns a value of -1 and stops execution of the calibration.
- Lines 490 - 530     Decides whether to measure the Low-loss capacitor. If yes, the measurement is executed.
- Lines 550 - 570     Calculates the calibration coefficient and turns on the calibration function. After that, displays a message indicating completion of calibration.
- Lines 590 - 710     Reads the six calibration coefficient arrays in ASCII transfer format.
- Lines 730 - 740     Reads the number of measurements.
- Lines 760 - 1000    Saves the calibration coefficient array to a floppy disk. After that, displays a message indicating the completion of read and write operations of the calibration coefficient.
- Line 1020            Stops execution of the macro.
- Line 1100            Prompts connection of the calibration measurement standard.
- Lines 1150 - 1240   Measures the calibration data using the CalMeasure method after the standard is connected. The CalMeasure method returns the value of 1 when measurement is completed without problem but it returns the value of 0 when measurement is aborted during fixture compensation.
- Lines 1260 - 1310   Displays a message when measurement is aborted, and the function program returns the value of -1. When measurement is completed without problem, it returns the value of 0.
- Line 1330            When the standard is not connected, the function program returns the value of -1.
- Lines 1380 - 1420   Inputs the specified data.

**Example 4-2**

**Measurement of data for calibration (macro)**

4. Preparation for Accurate Measurement

## Preparation for Accurate Measurement Calibration

```
10 Sub Main()
20 Dim buff As String, file As String
30 Dim Cal_kit As String, Cal_point As String
40 Dim Cal_a1 As Variant, Cal_a2 As Variant
50 Dim Cal_b1 As Variant, Cal_b2 As Variant
60 Dim Cal_c1 As Variant, Cal_c2 As Variant
70 Dim Open_g As Double, Open_c As Double
80 Dim Short_r As Double, Short_l As Double
90 Dim Load_r As Double, Load_l As Double
100 Dim Result As Integer, Nop_cal As Integer, Inp_char As
Integer
110 Dim iFileNo As Integer, i As Integer
120
130 Cal_kit = "DEF" 'DEF/USER
140 Cal_point = "FIX" 'FIX/FUS/USER
150
160 SCPI.Output "SENS:CORR1:CKIT " & Cal_kit
170 SCPI.Output "SENS:CORR1:COLL:FPO " & Cal_point
180
190 If Cal_kit = "USER" Then
200
210 SCPI.Output "SENS:CORR1:CKIT:LIST OFF"
220
230 Call Inp_data("Open_G(S)", Open_g)
240 Call Inp_data("Open_C(F)", Open_c)
250 SCPI.Output "SENS:CORR1:CKIT:STAN1:G " & CStr(Open_g)
260 SCPI.Output "SENS:CORR1:CKIT:STAN1:C " & CStr(Open_c)
270
280 Call Inp_data("Short_R(ohm)", Short_r)
290 Call Inp_data("Short_L(H)", Short_l)
300 SCPI.Output "SENS:CORR1:CKIT:STAN2:R " & CStr(Short_r)
310 SCPI.Output "SENS:CORR1:CKIT:STAN2:L " & CStr(Short_l)
320
330 Call Inp_data("Load_R(ohm)", Load_r)
340 Call Inp_data("Load_L(H)", Load_l)
350 SCPI.Output "SENS:CORR1:CKIT:STAN3:R " & CStr(Load_r)
360 SCPI.Output "SENS:CORR1:CKIT:STAN3:L " & CStr(Load_l)
370
380 End If
390
400 Result = Cal("Open")
410 If Result <> 0 Then GoTo Prog_end
420
430 Result = Cal("Short")
440 If Result <> 0 Then GoTo Prog_end
450
460 Result = Cal("Load")
470 If Result <> 0 Then GoTo Prog_end
480
490 Inp_char = MsgBox("Do you want to measure a Low-Loss
Capacitor?", vbYesNo + vbQuestion, "Calibration")
500 If Inp_char = vbYes Then
510 Result = Cal("Low-loss C")
520 If Result <> 0 Then GoTo Prog_end
530 End If
540
550 SCPI.Output "SENS:CORR1:COLL:SAVE"
560 buff = SCPI.Query("*OPC?")
```



```

570     MsgBox "All cal-data measurement completion", vbOKOnly,
"Calibration"
580
590     SCPI.Output "FORM:DATA ASC"
600     SCPI.Output "DATA:CCO1?"
610     SCPI.Enter Cal_a1, "#"
620     SCPI.Output "DATA:CCO2?"
630     SCPI.Enter Cal_b1, "#"
640     SCPI.Output "DATA:CCO3?"
650     SCPI.Enter Cal_c1, "#"
660     SCPI.Output "DATA:CCO4?"
670     SCPI.Enter Cal_a2, "#"
680     SCPI.Output "DATA:CCO5?"
690     SCPI.Enter Cal_b2, "#"
700     SCPI.Output "DATA:CCO6?"
710     SCPI.Enter Cal_c2, "#"
720
730     SCPI.Output "SWE:POIN?"
740     SCPI.Enter Nop_cal
750
760     iFileNo = FreeFile
770     file = "a:\CAL_COEF"
780
790     Open file For Output As iFileNo
800     For i = 1 To Nop_cal * 2
810         Write #iFileNo, Val(Cal_a1(i - 1))
820     Next i
830     For i = 1 To Nop_cal * 2
840         Write #iFileNo, Val(Cal_b1(i - 1))
850     Next i
860     For i = 1 To Nop_cal * 2
870         Write #iFileNo, Val(Cal_c1(i - 1))
880     Next i
890     For i = 1 To Nop_cal * 2
900         Write #iFileNo, Val(Cal_a2(i - 1))
910     Next i
920     For i = 1 To Nop_cal * 2
930         Write #iFileNo, Val(Cal_b2(i - 1))
940     Next i
950     For i = 1 To Nop_cal * 2
960         Write #iFileNo, Val(Cal_c2(i - 1))
970     Next i
980     Close #iFileNo
990
1000    MsgBox "Saving Calibration Coefficient File Completion",
vbOKOnly, "Calibration"
1010
1020    Prog_end: End
1030
1040    End Sub
1050
1060    Function Cal(Standard As String) As Integer
1070        Dim Inp_char As Integer
1080        Dim bool As Long
1090
1100        Inp_char = MsgBox("Connect " & Standard & _
1110            " standard to DUT port.", _
1120            vbOKCancel, "Calibration")

```

## Preparation for Accurate Measurement Calibration

```
1130
1140     If Inp_char = vbOK Then
1150         Select Case Standard
1160             Case "Open"
1170                 bool = CalMeasure(CalOpen)
1180             Case "Short"
1190                 bool = CalMeasure(CalShort)
1200             Case "Load"
1210                 bool = CalMeasure(CalLoad)
1220             Case "Low-loss C"
1230                 bool = CalMeasure(CalLowLossC)
1240             End Select
1250
1260         If bool = 0 Then
1270             MsgBox Standard & " Calibration aborted!", vbOKOnly,
"Calibration"
1280             Cal = -1
1290         Else
1300             Cal = 0
1310         End If
1320     Else
1330         Cal = -1
1340     End If
1350
1360 End Function
1370
1380 Sub Inp_data(Mes As String, Inp_val As Double)
1390
1400     Inp_val = Val(InputBox(Mes, "Input values"))
1410
1420 End Sub
```

**Example program for calibration coefficient transfer**

The example program shown below is for transferring a saved calibration coefficient array.

**Example program using HTBasic**

Example 4-3 shows an example program that enables the calibration function by transferring the calibration coefficient array saved in Example 4-1. This program is saved under the filename cal\_inp.htb on the sample programs disk.

Line 70	Sets the GPIB address.
Line 90	Substitutes a variable for the file name for storing the calibration coefficient array.
Lines 110 - 180	Confirms whether the calibration function should be set to on. If yes, completes the program.
Lines 200 - 210	Reads the number of measurement points and substitutes a variable for it.
Lines 230 - 250	Re-allocates a value for the range of the calibration coefficient array using the number of measurement points.
Lines 300 - 320	Reads the calibration coefficient array stored in the external computer.
Lines 360 - 420	Transfers the calibration coefficient array from the external computer to the E4991A.

**Example 4-3****Transfer of calibration coefficient array (HTBasic)**

```

10   DIM File$(20)
20   DIM Cal_a1(1:801,1:2),Cal_a2(1:801,1:2)
30   DIM Cal_b1(1:801,1:2),Cal_b2(1:801,1:2)
40   DIM Cal_c1(1:801,1:2),Cal_c2(1:801,1:2)
50   INTEGER Nop,Corr
60   !
70   ASSIGN @Agte4991a TO 717
80   !
90   File$="CAL_COEF"
100  !
110  OUTPUT @Agte4991a;"SENS:CORR1?"
120  ENTER @Agte4991a;Corr
130  !
140  IF Corr=0 THEN
150    BEEP
160    PRINT " It is not available to transfer calibration
coefficient data to E4991A"
170    GOTO Prog_end
180  END IF
190  !
200  OUTPUT @Agte4991a;"SWE:POIN?"
210  ENTER @Agte4991a;Nop
220  !
230  REDIM Cal_a1(1:Nop,1:2),Cal_a2(1:Nop,1:2)
240  REDIM Cal_b1(1:Nop,1:2),Cal_b2(1:Nop,1:2)
250  REDIM Cal_c1(1:Nop,1:2),Cal_c2(1:Nop,1:2)
260  !
270  !
280  ! Load Data

```

## Preparation for Accurate Measurement Calibration

```
290      !
300      ASSIGN @File TO File$
310      ENTER
@File;Cal_a1(*),Cal_b1(*),Cal_c1(*),Cal_a2(*),Cal_b2(*),Cal_c2(*)
320      ASSIGN @File TO *
330      !
340      ! Input Calibration Data
350      !
360      OUTPUT @Agte4991a;"FORM:DATA ASC"
370      OUTPUT @Agte4991a;"DATA:CCO1 ";Cal_a1(*)
380      OUTPUT @Agte4991a;"DATA:CCO2 ";Cal_b1(*)
390      OUTPUT @Agte4991a;"DATA:CCO3 ";Cal_c1(*)
400      OUTPUT @Agte4991a;"DATA:CCO4 ";Cal_a2(*)
410      OUTPUT @Agte4991a;"DATA:CCO5 ";Cal_b2(*)
420      OUTPUT @Agte4991a;"DATA:CCO6 ";Cal_c2(*)
430      !
440      PRINT "Data writting succeed!"
450      !
460 Prog_end:~
470      END
```

### Example program using macro (E4991A VBA)

Example 4-4 shows an example program that enables the calibration function by transferring the calibration coefficient array saved in Example 4-2. This is saved under the filename cal\_inp.bas on the sample programs disk.

Line 70	Sets the GPIB address.
Line 90	Substitutes a variable for the file name for storing the calibration coefficient array.
Lines 110 - 180	Confirms whether the calibration function should be set to on. If yes, completes the program.
Lines 200 - 210	Reads the number of measurement points and substitutes a variable for it.
Lines 230 - 250	Re-allocates a value to the range of the calibration coefficient array using the number of measurement points.
Lines 300 - 320	Reads the calibration coefficient array stored in the external computer.
Lines 360 - 420	Transfers the calibration coefficient array from the external computer to the E4991A.

#### Example 4-4

#### Transfer of calibration coefficient array (macro)

```

10      Sub Main()
20          Dim file As String
30          Dim Cal_a1() As Double, Cal_a2() As Double
40          Dim Cal_b1() As Double, Cal_b2() As Double
50          Dim Cal_c1() As Double, Cal_c2() As Double
60          Dim a1_data As String, a2_data As String
70          Dim b1_data As String, b2_data As String
80          Dim c1_data As String, c2_data As String
90          Dim Corr As Integer, Nop_cal As Integer
100         Dim iFileNo As Integer, i As Integer
110
120         SCPI.Output "SENS:CORR1?"
130         SCPI.Enter Corr
140         If Corr = 0 Then
150             MsgBox "It is unable to transfer calibration coefficient
data to E4991A", vbOKOnly + vbExclamation, "Transfer"
160             GoTo Prog_end
170         End If
180
190         SCPI.Output "SWE:POIN?"
200         SCPI.Enter Nop_cal
210
220         ReDim Cal_a1(1 To Nop_cal * 2), Cal_a2(1 To Nop_cal * 2)
230         ReDim Cal_b1(1 To Nop_cal * 2), Cal_b2(1 To Nop_cal * 2)
240         ReDim Cal_c1(1 To Nop_cal * 2), Cal_c2(1 To Nop_cal * 2)
250
260         ' -> Load Data
270
280         file = "a:\CAL_COEF"
290         iFileNo = FreeFile
300
310         Open file For Input As iFileNo

```

## Preparation for Accurate Measurement Calibration

```
320     For i = 1 To Nop_cal * 2
330         Input #iFileNo, Cal_a1(i)
340     Next i
350     For i = 1 To Nop_cal * 2
360         Input #iFileNo, Cal_b1(i)
370     Next i
380     For i = 1 To Nop_cal * 2
390         Input #iFileNo, Cal_c1(i)
400     Next i
410     For i = 1 To Nop_cal * 2
420         Input #iFileNo, Cal_a2(i)
430     Next i
440     For i = 1 To Nop_cal * 2
450         Input #iFileNo, Cal_b2(i)
460     Next i
470     For i = 1 To Nop_cal * 2
480         Input #iFileNo, Cal_c2(i)
490     Next i
500
510     Close #iFileNo
520
530     data_a1 = Cal_a1(1)
540     data_b1 = Cal_b1(1)
550     data_c1 = Cal_c1(1)
560     data_a2 = Cal_a2(1)
570     data_b2 = Cal_b2(1)
580     data_c2 = Cal_c2(1)
590     For i = 2 To Nop_cal * 2
600         data_a1 = data_a1 & "," & Cal_a1(i)
610         data_b1 = data_b1 & "," & Cal_b1(i)
620         data_c1 = data_c1 & "," & Cal_c1(i)
630         data_a2 = data_a2 & "," & Cal_a2(i)
640         data_b2 = data_b2 & "," & Cal_b2(i)
650         data_c2 = data_c2 & "," & Cal_c2(i)
660     Next i
670
680     ' -> Input Calibration Data
690
700     SCPI.Output "FORM:DATA ASC"
710     SCPI.Output "DATA:CC01 " & data_a1
720     SCPI.Output "DATA:CC02 " & data_b1
730     SCPI.Output "DATA:CC03 " & data_c1
740     SCPI.Output "DATA:CC04 " & data_a2
750     SCPI.Output "DATA:CC05 " & data_b2
760     SCPI.Output "DATA:CC06 " & data_c2
770
780     MsgBox "Data Writing succeed!", vbOKOnly, "Transfer"
790
800     End
810
820 Prog_end: End Sub
```

## Electrical Length Compensation

### Test Fixture

#### Selection (Set Electrical Length)

Use the following GPIB command to select whether to use the Agilent test fixture or a custom test fixture.

- **SENS:CORR2:FIXT** on page 454

Table 4-1 lists the valid combination of test fixtures, the need for Option 002 (Material Measurement option), and measurement modes.

Table 4-1

Test Fixture List

Test Fixture	Material measurement option	Measurement mode
Agilent 16191A	Not needed	Impedance
Agilent 16192A		
Agilent 16193A		
Agilent 16194A		
Agilent 16196A		
Agilent 16196B		
Agilent 16196C		
Agilent 16197A		
Agilent 16453A	Needed	Dielectric material
Agilent 16454S		Magnetic material
Agilent 16454L		
Custom (User-created)	Not needed	Impedance

If the Agilent test fixture is used, the electrical length of the test fixture is set to the E4991A's predefined value, eliminating the need to enter the value. Use the following GPIB command to read the electrical length of the Agilent test fixture.

- **SENS:CORR2:FIXT:EDEL:MODE:DIST?** on page 455

#### Custom Test Fixture (Enter Electrical Length)

When you use a custom test fixture, use the following GPIB command to define the electrical length of the test fixture.

- **SENS:CORR2:FIXT:EDEL:USER:DIST** on page 456

### **Add Offset Delay Time (Port Extension Compensation)**

In addition to the electrical length of the test fixture, if offset delay time occurs due to port extension, use the following GPIB command to remove the offset delay time.

- **SENS:CORR2:EDEL:TIME** on page 453



## Fixture Compensation

The following section explains how to perform fixture compensation.

### Define Fixture Compensation Kit

The values of the Open/Short standard included with the fixture compensation kit can be set to any values.

#### How to Enter Standard Values

Use the following GPIB command to select whether the values of the Open/Short standard included with the fixture compensation kit should be set to a single value or to a different value for each frequency.

- **SENS:CORR2:CKIT:LIST** on page 440

#### Standard Value (Single Value)

Use the following GPIB commands to define the Open/Short standard values as a single value common to each frequency.

Standard	Parameter	GPIB command
Open	Conductance value (G)	<b>SENS:CORR2:CKIT:STAN1:G</b> on page 442
	Capacitance value (C)	<b>SENS:CORR2:CKIT:STAN1:C</b> on page 441
Short	Resistance value (R)	<b>SENS:CORR2:CKIT:STAN2:R</b> on page 448
	Inductance value (L)	<b>SENS:CORR2:CKIT:STAN2:L</b> on page 445

#### Standard Value Array (For Each Frequency)

By defining Open/Short standard values of the fixture compensation kit as an array for each frequency, errors due to frequency characteristics of the standard can be removed. Use the following GPIB commands to define standard values as an array for each frequency.

Standard	Parameter	GPIB command
Open	Conductance value (G)	<b>SENS:CORR2:CKIT:STAN1:LIST:G</b> on page 444
	Susceptance value (B)	<b>SENS:CORR2:CKIT:STAN1:LIST:B</b> on page 443
Short	Resistance value (R)	<b>SENS:CORR2:CKIT:STAN2:LIST:R</b> on page 446
	Reactance value (X)	<b>SENS:CORR2:CKIT:STAN2:LIST:X</b> on page 447

### Select Fixture Compensation Data Measurement Points

Select fixture compensation data measurement points from the following table. Note that when fixed points are used to measure fixture compensation data, fixture compensation coefficients are calculated through interpolation.

Measurement points	Description
Fixed frequency / fixed power points compensation	Measures fixture compensation data at the E4991A predefined fixed frequency points and over the entire oscillator range.
Fixed frequency / user defined power points compensation	Measures fixture compensation data at the E4991A predefined fixed frequency points and at user-defined oscillator level.
User-defined frequency / user defined power points compensation	Measures fixture compensation data at user defined frequency points and at user defined oscillator level.

Use the following GPIB command to select fixture compensation data measurement points.

- **SENS:CORR2:COLL:FPO** on page 450

---

**NOTE**

Calibration data measurement points are set in coordination with fixture compensation data measurement points. To select calibration data measurement points, use the **SENS:CORR1:COLL:FPO** command.

---

## Measure Fixture Compensation Data

### Perform Measurement

Use the following GPIB command to measure the Open/Short fixture compensation data used to calculate fixture compensation coefficients.

- **SENS:CORR2:COLL** on page 449

---

#### NOTE

With a trigger source is set to an external trigger, the above command does not start measurement of fixture compensation data. After executing this command, prepare a trigger.

Completion of fixture compensation data measurement can be detected by monitoring when status bit 7 of the Operation Status Event Register changes. Use one of the following GPIB commands to monitor the status bit.

- **STAT:OPER:PTR** on page 492
- **STAT:OPER:NTR** on page 491
- **STAT:OPER:ENAB** on page 490
- **\*SRE** on page 283

### Enable Fixture Compensation Function

After measuring Open/Short fixture compensation data, use the following GPIB command to calculate fixture compensation coefficients. This GPIB command automatically enables the fixture compensation function.

- **SENS:CORR2:COLL:SAVE** on page 451

---

#### NOTE

Calculation of fixture compensation coefficients requires Open and Short measurement data. If the above command is executed before all data measurement is complete, an error occurs and the command is ignored.

The following GPIB commands disable/enable Open and Short fixture compensation, respectively.

- **SENS:CORR2:COLL:OPEN** on page 451
- **SENS:CORR2:COLL:SHOR** on page 452

---

#### NOTE

If the above commands are used to enable the Open/Short compensation function before Open /Short compensation data is measured, an error occurs and the command is ignored.

### **Fixture Compensation Data Array/Fixture Compensation Coefficient Array**

The fixture compensation data array contains Open or Short measurement data in the complex format. This data is used for calculating fixture compensation coefficients. The fixture compensation coefficient array contains fixture compensation coefficients in the complex format. These coefficients are calculated by using the Open or Short measurement data.

The fixture compensation data and coefficient arrays can be read. The fixture compensation coefficient array, once read, can be written back again.

#### **Read Fixture Compensation Data Array**

For details on how to read the fixture compensation data array, refer to “Fixture Compensation Data Arrays” on page 127.

#### **Read and Write Fixture Compensation Coefficient Array**

For details on how to read and write the fixture compensation coefficient array, refer to “Fixture Compensation Coefficient Arrays” on page 128.

## Example program for execution of fixture compensation

After connecting a text fixture, the program shown below enables the fixture compensation function of the fixture compensation kit. In this program, after defining the standard values for the Open/Short state of the fixture compensation kit by using values prepared by the user, the fixture compensation function is enabled by measuring each standard. In addition, when the fixture compensation function is enabled, the internally calculated fixture compensation coefficient is saved in the external controller.

### Example program using HTBasic

The program shown in Example 4-5 is saved under the filename `com_meas.htb` on the programs disk. The details of this program are explained as follows.

Line 80	Sets the GPIB address.
Lines 120 - 130	Substitutes a variable for the type of text fixture and the obtained fixture compensation data point.
Lines 150 - 160	Sets the type of text fixture and the obtained fixture compensation data point.
Lines 200 - 230	When a custom test fixture is selected, defines the electrical length of the test fixture.
Lines 250 - 270	Asks whether to define the standard values for the fixture compensation kit with the values prepared by the user.
Line 280	When each standard value is defined with a value prepared by the user, the program branches to define each standard value for the fixture compensation kit.
Line 300	Without using the list-setting function of the fixture compensation kit, selects a setting that defines each standard value at a common unique value over all frequencies.
Lines 340 - 440	Defines the values of Open (G-C) and Short (R-L). However, each standard value is defined in the sub-program ( <code>Inp_data</code> ).
Lines 490 - 550	Measures the fixture compensation data for the Open/Short state standard. However, measurement of the fixture compensation data is performed in the function sub-program ( <code>FNFixt_comp</code> ). Despite whether there is any GPIB error during measurement of the fixture compensation data that comes back as a return value of the function sub-program, when an error is detected, the execution of the fixture compensation is halted at that point.
Lines 590 - 630	Calculates the fixture compensation coefficient and turns on the fixture compensation function. After that, displays completion of execution of the fixture compensation.
Lines 670 - 690	Reads the number of points in a sweep and, using those values, resets the range of array variables used when the fixture compensation coefficient is read.
Lines 710 - 750	Reads the two arrays of fixture compensation coefficients in ASCII transfer format.
Lines 770 - 840	Saves the read arrays of the fixture compensation coefficient in binary format in the external computer. After that, displays completion of

## Preparation for Accurate Measurement Fixture Compensation

	read and write operations of the fixture compensation coefficient.
Lines 940 - 950	Prompts connection of the standard for fixture compensation measurement specified by the variable Standard\$ and waits for the input of <b>[Y]</b> or <b>[y]</b> after the connection.
Line 970	Clears the status byte register and operation status event register.
Lines 980 - 990	Sets the operation status event register bit 7 to 1 only when the operation status condition register bit 7 transits from 1 to 0 (negative transition).
Lines 1000 - 1010	Sets the operation status condition so that register bit 7 is enabled and, upon completion of fixture compensation, sets it so that status byte register bit 7 is enabled.
Lines 1020 - 1030	Sets the branch for SRQ interruption and enables SRQ interruption.
Lines 1040 - 1090	Sends the execute command for the fixture compensation of the standard specified by the variable Standard\$ and measures the fixture compensation data.
Lines 1100 - 1110	Displays a message indicating measurement is in progress and waits for completion of the measuring.
Lines 1130 - 1290	Checks whether a GPIB error occurred in the E4991A during measurement. If no error occurred, displays a message indicating completion of measurement and returns a value of 0 from the function sub-program. If an error occurred, displays an error message and a measurement halt message and returns a value of -1 from the function sub-program.
Lines 1340 - 1350	Prompts the input of the standard value of the user-defined fixture compensation kit specified by the variable Mes\$ and waits for the input.
Lines 1360 - 1390	Displays the input value and waits for input (made by using the <b>[Y/N]</b> keys) on whether it is accurate. If a key other than <b>[Y]</b> or <b>[y]</b> is pressed, it returns to the first line of the input.

### Example 4-5

#### Measurement of fixture compensation data (HTBasic)

```
10 DIM Inp_char$(9),Buff$(9),File$(20)
20 DIM Fix_type$(9),Cal_point$(9)
30 DIM Comp_a(1:801,1:2),Comp_b(1:801,1:2)
40 REAL E_length,Open_g,Open_c,Short_r,Short_l
50 INTEGER Result,Nop_comp,Data_size
60 !
70 CLEAR SCREEN
80 ASSIGN @Agte4991a TO 717
90 !
100 ! Initial Setting
110 !
120 Fix_type$="USER" !
USER/FXT16191A/FXT16192A/.....
130 Cal_point$="FIX" ! FIX/FUS/USER
140 !
150 OUTPUT @Agte4991a;"SENS:CORR2:FIXT "&Fix_type$
160 OUTPUT @Agte4991a;"SENS:CORR2:COLL:FPO "&Cal_point$
170 !
```

```

180      ! Entry Electrical Length of User's Test Fixture
190      !
200      IF Fix_type$="USER" THEN
210          CALL Inp_data("User's Fixture Electrical
Delay(m)",E_length)
220          OUTPUT @Agte4991a;"SENS:CORR2:FIXT:EDEL:USER:DIST
"&VAL$(E_length)
230      END IF
240      !
250      PRINT "Do you want to entry the comp. standard values?"
260      PRINT
270      INPUT "[Y/N]",Inp_char$
280      IF UPC$(Inp_char$)="Y" THEN
290          !
300          OUTPUT @Agte4991a;"SENS:CORR2:CKIT:LIST OFF"
310          !
320          ! Entry Open Std. Value (G-C)
330          !
340          CALL Inp_data("Open(G)",Open_g)
350          CALL Inp_data("Open(C)",Open_c)
360          OUTPUT @Agte4991a;"SENS:CORR2:CKIT:STAN1:G "&VAL$(Open_g)
370          OUTPUT @Agte4991a;"SENS:CORR2:CKIT:STAN1:C "&VAL$(Open_c)
380          !
390          ! Entry Short Std. Value (R-L)
400          !
410          CALL Inp_data("Short(R)",Short_r)
420          CALL Inp_data("Short(L)",Short_l)
430          OUTPUT @Agte4991a;"SENS:CORR2:CKIT:STAN2:R "&VAL$(Short_r)
440          OUTPUT @Agte4991a;"SENS:CORR2:CKIT:STAN2:L "&VAL$(Short_l)
450      END IF
460      !
470      ! Open Data Measurement
480      !
490      Result=FNFixt_comp(@Agte4991a,"Open")
500      IF Result<>0 THEN Prog_end
510      !
520      ! Short Data Measurement
530      !
540      Result=FNFixt_comp(@Agte4991a,"Short")
550      IF Result<>0 THEN Prog_end
560      !
570      ! Fixture Compensation Done
580      !
590      OUTPUT @Agte4991a;"SENS:CORR2:COLL:SAVE"
600      OUTPUT @Agte4991a;"*OPC?"
610      ENTER @Agte4991a;Buff$
620      PRINT "All Data Measurement Complete"
630      PRINT
640      !
650      ! Fixture Compensation Coefficient Array Reading & Saving
660      !
670      OUTPUT @Agte4991a;"SWE:POIN?"
680      ENTER @Agte4991a;Nop_comp
690      REDIM Comp_a(1:Nop_comp,1:2),Comp_b(1:Nop_comp,1:2)
700      !
710      OUTPUT @Agte4991a;"FORM:DATA ASC"
720      OUTPUT @Agte4991a;"DATA:CMPL?"
730      ENTER @Agte4991a;Comp_a(*)

```

## Preparation for Accurate Measurement Fixture Compensation

```
740 OUTPUT @Agte4991a;"DATA:COMP2?"
750 ENTER @Agte4991a;Comp_b(*)
760 !
770 File$="COMP_COEF"
780 Data_size=(Nop_comp*2*2)*8
790 CREATE File$,Data_size
800 ASSIGN @File TO File$;FORMAT OFF
810 OUTPUT @File;Comp_a(*),Comp_b(*)
820 ASSIGN @File TO *
830 !
840 PRINT "Compensation Coefficient File Saving Complete"
850 !
860 Prog_end: END
870 !
880 ! Fixture Compensation Data Measurement Function
890 !
900 DEF FNFixt_comp(@Agte4991a,Standard$)
910 DIM Inp_char$(9),Err_mes$(50)
920 INTEGER Err_no
930 !
940 PRINT "Connect "&Standard$&" Standard to electrodde plate
on the fixture."
950 INPUT "OK? [Y/N]",Inp_char$
960 IF UPC$(Inp_char$)="Y" THEN
970 OUTPUT @Agte4991a;"*CLS"
980 OUTPUT @Agte4991a;"STAT:OPER:PTR 0"
990 OUTPUT @Agte4991a;"STAT:OPER:NTR 128"
1000 OUTPUT @Agte4991a;"STAT:OPER:ENAB 128"
1010 OUTPUT @Agte4991a;"*SRE 128"
1020 ON INTR 7 GOTO Meas_end
1030 ENABLE INTR 7;2
1040 SELECT Standard$
1050 CASE "Open"
1060 OUTPUT @Agte4991a;"SENS:CORR2:COLL STAN1"
1070 CASE "Short"
1080 OUTPUT @Agte4991a;"SENS:CORR2:COLL STAN2"
1090 END SELECT
1100 DISP "Now measuring..."
1110 Meas_wait: GOTO Meas_wait
1120 Meas_end: DISP
1130 OUTPUT @Agte4991a;"SYST:ERR?"
1140 ENTER @Agte4991a;Err_no,Err_mes$
1150 IF Err_no=0 THEN
1160 PRINT Standard$&" data measurement completion"
1170 PRINT
1180 RETURN 0
1190 ELSE
1200 PRINT "Error: "&Err_mes$
1210 PRINT "Program interruption"
1220 PRINT
1230 RETURN -1
1240 END IF
1250 ELSE
1260 PRINT "Program interruption"
1270 PRINT
1280 RETURN -1
1290 END IF
1300 FNEND
```



```
1310  !
1320  SUB Inp_data(Mes$,Inp_val)
1330    DIM Inp_char$(9)
1340    PRINT "Input "&Mes$
1350  Inp_start: INPUT "Value?",Inp_val
1360    PRINT Mes$&" Value: ";Inp_val
1370    PRINT
1380    INPUT "OK? [Y/N]",Inp_char$
1390    IF UPC$(Inp_char$)<>"Y" THEN Inp_start
1400  SUBEND
```

## Preparation for Accurate Measurement Fixture Compensation

### Example program using macro (E4991A VBA)

The program shown in Example 4-6 is saved under the filename com\_meas.bas on the programs disk. The details of this program are explained as follows.

Lines 110 - 120	Substitutes a variable for the type of text fixture and the obtained fixture compensation data point.
Lines 140 - 150	Sets the type of test fixture and the obtained fixture compensation data point.
Lines 170 - 200	When a custom test fixture is selected (defines variable of Fixt_type to USER), defines the electrical length of the test fixture.
Line 220	Asks whether to define the standard values for the fixture compensation kit with the values prepared by the user.
Line 230	When the standard value is defined with the values prepared by the user, the program branches to define each standard value of the fixture compensation kit.
Line 250	Without using the list-setting function of the fixture compensation kit, selects a setting that defines each standard value at a common unique value over all frequencies.
Lines 270 - 350	Defines the standard values of Open (G-C) and Short (R-L). The definition of each standard value is performed in the procedure (Inp_data).
Lines 390 - 430	Measures the fixture compensation data for the Open/Short standard. This measurement is performed in the function program (Fixt_comp). When measurement is aborted during fixture compensation, the function program returns the value of -1 and stops execution of the fixture compensation.
Lines 450 - 470	Calculates the fixture compensation coefficient and turns on the fixture compensation function. After that, displays completion of fixture compensation.
Lines 490 - 530	Reads the two arrays of the fixture compensation coefficients in ASCII transfer format.
Lines 550 - 560	Reads the number of measurement points.
Lines 580 - 690	Saves the two fixture compensation coefficient arrays to a floppy disk. After that, displays completion of transferring the fixture compensation coefficient arrays.
Line 710	Stops the execution of the macro.
Line 790	Prompts connection of the standard for fixture compensation measurement specified by the variable of the Standard.
Lines 840 - 890	Measures the fixture compensation data by the CompenMeasure method after the standard is connected. The CompenMeasure method returns the value of 1 when measurement is completed without problem and the value of 0 when measurement is aborted during fixture compensation.
Lines 900 - 950	Displays a message when measurement is aborted, and the function program returns the value of -1. When measurement is completed

without problem, it returns the value of 0.

Line 970 When the standard is not connected, the function program returns the value of -1.

Lines 1020 - 1060 Inputs the specified data.

#### Example 4-6

#### Measurement of fixture compensation data (macro)

```

10      Sub Main()
20          Dim buff As String, file As String
30          Dim Fixt_type As String, Cal_point As String
40          Dim Comp_a As Variant, Comp_b As Variant
50          Dim E_length As Double
60          Dim Open_g As Double, Open_c As Double
70          Dim Short_r As Double, Short_l As Double
80          Dim Result As Integer, Nop_comp As Integer, Inp_char As
Integer
90          Dim iFileNo As Integer, i As Integer
100
110         Fixt_type = "USER"      'USER/FXT16191A/FXT16192A/...
120         Cal_point = "FIX"      'FIX/FUS/USER
130
140         SCPI.Output "SENS:CORR2:FIXT " & Fixt_type
150         SCPI.Output "SENS:CORR2:COLL:FPO " & Cal_point
160
170         If Fixt_type = "USER" Then
180             Call Inp_data("User's Test Fixture Electrical
Length(m)", E_length)
190             SCPI.Output "SENS:CORR2:FIXT:EDEL:USER:DIST " &
CStr(E_length)
200         End If
210
220         Inp_char = MsgBox("Do you want to entry the comp. standard
values?", vbYesNo + vbQuestion, "Compensation")
230         If Inp_char = vbYes Then
240
250             SCPI.Output "SENS:CORR2:CKIT:LIST OFF"
260
270             Call Inp_data("Open_G(S)", Open_g)
280             Call Inp_data("Open_C(F)", Open_c)
290             SCPI.Output "SENS:CORR2:CKIT:STAN1:G " & CStr(Open_g)
300             SCPI.Output "SENS:CORR2:CKIT:STAN1:C " & CStr(Open_c)
310
320             Call Inp_data("Short_R(ohm)", Short_r)
330             Call Inp_data("Short_L(H)", Short_l)
340             SCPI.Output "SENS:CORR2:CKIT:STAN2:R " & CStr(Short_r)
350             SCPI.Output "SENS:CORR2:CKIT:STAN2:L " & CStr(Short_l)
360
370         End If
380
390         Result = Fixt_comp("Open")
400         If Result <> 0 Then GoTo Prog_end
410
420         Result = Fixt_comp("Short")
430         If Result <> 0 Then GoTo Prog_end
440
450         SCPI.Output "SENS:CORR2:COLL:SAVE"
460         buff = SCPI.Query("*OPC?")

```

## Preparation for Accurate Measurement Fixture Compensation

```
470     MsgBox "All compen-data measurement completion", vbOKOnly,
"Compensation"
480
490     SCPI.Output "FORM:DATA ASC"
500     SCPI.Output "DATA:COMP1?"
510     SCPI.Enter Comp_a, "#"
520     SCPI.Output "DATA:COMP2?"
530     SCPI.Enter Comp_b, "#"
540
550     SCPI.Output "SWE:POIN?"
560     SCPI.Enter Nop_comp
570
580     iFileNo = FreeFile
590     file = "COMP_COEF"
600     Open file For Output As iFileNo
610     For i = 0 To Nop_comp - 1
620         Write #iFileNo, Val(Comp_a(2 * i)), Val(Comp_a(2 * i +
1))
630     Next i
640
650     For i = 0 To Nop_comp - 1
660         Write #iFileNo, Val(Comp_b(2 * i)), Val(Comp_b(2 * i +
1))
670     Next i
680     Close #iFileNo
690     MsgBox "Saving Compensation Coefficient File Completion",
vbOKOnly, "Compensation"
700
710     Prog_end: End
720
730     End Sub
740
750     Function Fixt_comp(Standard As String) As Integer
760         Dim Inp_char As Integer
770         Dim bool As Long
780
790         Inp_char = MsgBox("Connect " & Standard & _
800             " standard to electrode plate on the test
fixture.", _
810             vbOKCancel, "Compensation")
820
830         If Inp_char = vbOK Then
840             Select Case Standard
850                 Case "Open"
860                     bool = CompenMeasure(CompenOpen)
870                 Case "Short"
880                     bool = CompenMeasure(CompenShort)
890             End Select
900             If bool = 0 Then
910                 MsgBox Standard & " Compensation aborted!", vbOKOnly,
"Compensation"
920                 Fixt_comp = -1
930             Else
940                 Fixt_comp = 0
950             End If
960         Else
970             Fixt_comp = -1
980         End If
```

```
990  
1000 End Function  
1010  
1020 Sub Inp_data(Mes As String, Inp_val As Double)  
1030  
1040     Inp_val = Val(InputBox(Mes, "Input values"))  
1050  
1060 End Sub
```

Preparation for Accurate Measurement  
**Fixture Compensation**

---

## **5 Measurement Start and Detection of Measurement End**

This chapter explains how to prepare a trigger for starting measurement and detecting the end of measurement with the Agilent E4991A.

## Measurement Trigger (Measurement Start)

### Trigger System

The E4991A trigger system has three states: “Idle,” “Waiting for trigger,” and “Measuring,” as shown in Figure 5-1.

Figure 5-1

### Trigger System

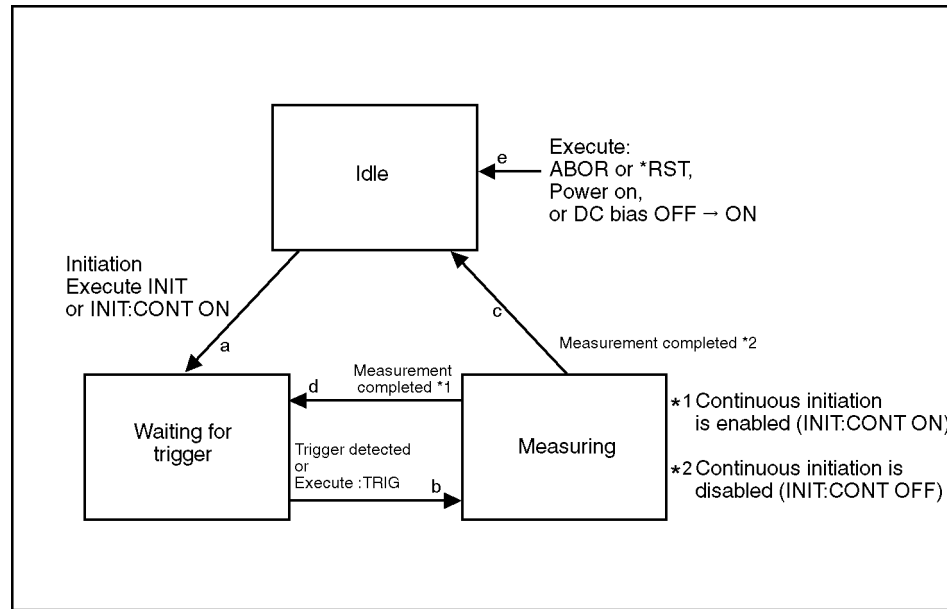

e4991ape026

The following section explains the state transitions of the trigger system.

### Idle State

Immediately after the E4991A is powered on, the trigger system is in the Idle state. However, the trigger system soon transits to the Waiting for trigger state because the trigger system’s continuous initiation feature is enabled and the trigger source is set to internal trigger. After that, the E4991A transits between the Measuring and Waiting for trigger states. Also, when one of the following GPIB commands is executed, the trigger system transits to the Idle state.

- **\*RST** on page 282
- **ABOR** on page 286

When the dc bias function has been switched from disabled to enabled, the trigger system transits to the Idle state.

If the trigger system has been initiated using the following GPIB command, the state changes from Idle to Waiting for trigger.

- **INIT** on page 382
- **INIT:CONT** on page 382



**Waiting for Trigger State (Trigger Detection State)**

When a trigger is made (detected) or the command for **TRIG** on page 525 is executed during Waiting for trigger, the trigger system transits to the Measurement state and measurement (sweep) starts. How a trigger is made depends on the trigger source setting. Use the following GPIB command to set the trigger source.

- **TRIG:SOUR** on page 526

Trigger source setting	How to make a trigger
Internal trigger (INT)	An internal trigger is made automatically.
External trigger (EXT) *1	When a trigger signal is input via the EXT TRIGGER connector on the rear panel, a trigger is made.
GPIB trigger (BUS)	When <b>*TRG</b> on page 284 is executed, a trigger is made.
Manual trigger (MAN)	When the <b>[Trigger]</b> key is pressed on the front panel, a trigger is made.

\*1. When an external trigger is selected, the command for **TRIG:SLOP** on page 526 can be used to set the polarity (positive/negative) of a trigger signal input through the EXT TRIGGER connector.

Use the following GPIB command to set the trigger detection points.

- **TRIG:EVENT** on page 525

Trigger detection points	Description
For each sweep	When a trigger event is detected, sweep is performed once. If sweep averaging is enabled, sweep is performed the same number of times as that of sweep averaging.
For each measurement point	When a trigger event is detected, measurement is performed at each measurement point.
For each segment	When a trigger event is detected during segment sweep, sweep is performed for each segment.

**NOTE**

Even with sweep averaging set to enabled and the trigger detection point set to “for each sweep,” by making a trigger first or by executing the **TRIG** command, sweep is repeated until the number of times specified for sweep averaging is completed.

## Measurement Start and Detection of Measurement End Measurement Trigger (Measurement Start)

Figure 5-2

### Transition from Waiting for Trigger to Measuring

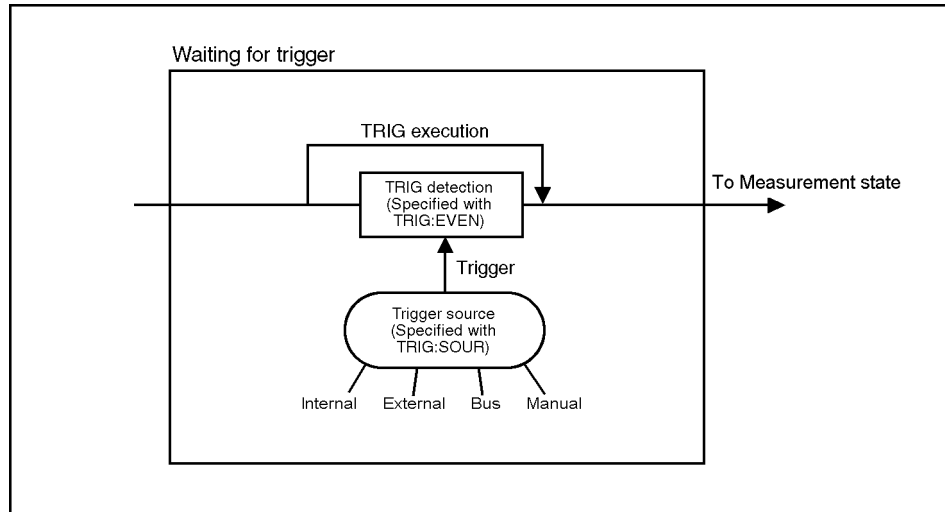

e4991ape034

### Measurement State

If delay time is specified in the Measurement state, measurement (sweep) starts after the specified delay time has elapsed.

When all of the measurements are completed, depending on the setting of the trigger system's continuous initiation (**INIT:CONT**), the trigger system transits as follows.

Continuous initiation OFF: Transits to Idle state.

Continuous initiation ON: Transits to Waiting for trigger state.

## Trigger Measurement

### Continuous Measurement (making a trigger automatically and continuously)

- Step 1.** Use the **TRIG:SOUR** command to set the trigger source to internal trigger.
- Step 2.** If the trigger system is not initiated (in Idle state), use the **INIT:CONT** command to enable the trigger system's continuous initiation.

### Measurement at any time (making a trigger from an external controller)

- Step 1.** Use the **TRIG:SOUR** command to set the trigger source to GPIB trigger.
- Step 2.** If the trigger system is not initiated (in Idle state), use the **INIT:CONT** command to enable the trigger system's continuous initiation.
- Step 3.** Make a trigger at any time. The following two GPIB commands can be used to make a trigger from an external controller as shown in the following table.

Command	Trigger source setting
*TRG on page 284	GPIB (BUS) trigger
TRIG on page 525	Manual, External or GPIB (BUS) trigger

- Step 4.** Repeat Step 3 to repeat measurement.  
Alternatively, you can follow the procedure below to perform measurement at any time.
- Step 1.** If the trigger system is already initiated (in a state other than Idle), use the **ABOR** command to terminate the trigger system.
- Step 2.** Use the **TRIG:SOUR** command to set the trigger source to internal trigger.
- Step 3.** Use the **INIT** command at any time to initiate the trigger system; a trigger is automatically made by an internal source and measurement is performed once.
- Step 4.** Repeat Step 3 to repeat measurement.

## Waiting for Measurement End (Detection of Sweep End)

### Using the Status Register

The state of the E4991A can be monitored through status registers. This section explains how to detect measurement end by using status registers. For details on the status report system, including bit configuration of status registers, see B, “GPIB Status Report System,” on page 551.

The Operation Status Event Register (see Table B-3 on page 561) indicates a measurement state. A Service Request (SRQ) is useful for detecting a measurement termination based on this information.

Use one of the following commands to detect a measurement end by using SRQ.

- **\*SRE** on page 283
- **STAT:OPER:ENAB** on page 490
- **STAT:OPER:PTR** on page 492
- **STAT:OPER:NTR** on page 491

Perform the following procedure to detect a measurement end.

- Step 1.** Configure the E4991A to generate an SRQ when the Measuring bit (set to 1 during measurement) in the Operation Status Event Register changes from 1 to 0.
- Step 2.** Make a trigger to start measurement.
- Step 3.** When the SRQ is generated, an interrupt is executed in the program.

---

#### NOTE

If sweep averaging is enabled, the E4991A generates an SRQ after measurement is made the same number of times as that of the sweep averaging specified.

Figure 5-3 SRQ Generation Sequence (at measurement end)

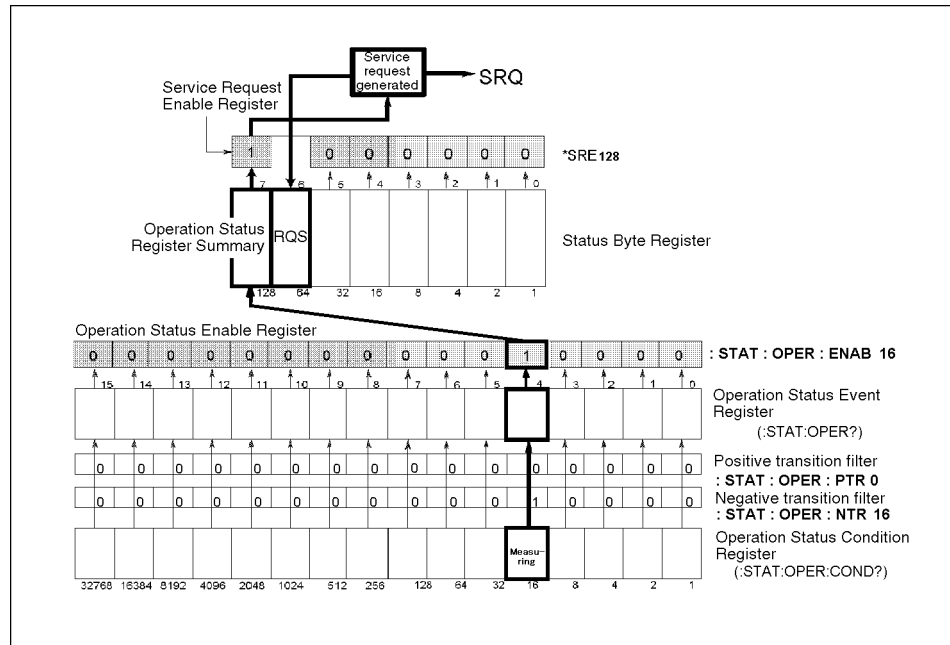

e4991ape031

### Adding Wait Time

The user can have a controller wait until the E4991A completes measurement by using, for example, the WAIT command in HTBasic. Using this command is very simple, but if the wait time is improperly set, an unexpected error may result.

## Example Programs for Detecting Measurement End

The following example programs can be used for the detection of measurement end.

### Example program using HTBasic (SRQ)

Example 5-1 shows an example program for detecting measurement end by using an SRQ. After setting the number of times for sweep averaging at 4 and setting the SRQ, a sweep is performed four times. Then, when the SRQ for the measurement end occurs, a message indicating completion is displayed and the program ends. This program is saved under the filename swp\_srq.htb on the sample programs disk. The details of the program are explained below.

Line 50	Sets the GPIB address of the E4991A.
Lines 70 - 80	Substitutes variables for the trace number and the number of sweep averaging.
Lines 100 - 120	Turns on Trace 1 and activates the sweep averaging function.
Lines 140 - 160	Sets the trigger source for the internal trigger and turns off the continuous activation of the trigger system. Then, resets the trigger system and sets the trigger sequence to the idle state.
Line 180	Performs a sweep and calls the sub-program for detecting measurement end.
Lines 260 - 280	Reads the on/off status of the sweep averaging function and substitutes a variable for the status. Next, when the sweep averaging function is turned on, resets the averaging and returns the averaging counter to zero.
Lines 300 - 310	Set so that only when the operation status condition register bit 4 transits from 1 to 0 (negative transition), the operation status event register bit 4 is set at 1.
Lines 320 - 330	Sets the instrument so that the operation status event register bit 4 is enabled and the status byte register bit 7 is effective.

---

**NOTE** The bit indicating measurement in progress when calibration and fixture compensation data are measured is prepared separately from other bits indicating a measurement in progress. To detect the completion of these, set the instrument so that the operation status condition register bit 0 is enabled.

---

**NOTE** When the sweep averaging function is set on, the measurement end is detected upon completion of the specified number of times for averaging.

---

Lines 340 -360	Clears the status byte register and operation status register.
Lines 380 - 390	Sets the branch for the SRQ interruption and enables the SRQ interruption.
Line 400	Starts measurement.
Line 420	Waits for the completion of measurement.

Lines 430 - 440 Indicates measurement end and disables the SRQ interruption.

**Example 5-1**

**Detection of measurement end using the SRQ**

```
10 DIM Buff$[9]
20 INTEGER Trc, Swp_count
30 !
40 CLEAR SCREEN
50 ASSIGN @Agte4991a TO 717
60 !
70 Trc=1
80 Swp_count=4
90 !
100 OUTPUT @Agte4991a;"DISP:TRAC"&VAL$(Trc)&" ON"
110 OUTPUT @Agte4991a;"CALC:AVER:COUN "&VAL$(Swp_count)
120 OUTPUT @Agte4991a;"CALC:AVER ON"
130 !
140 OUTPUT @Agte4991a;"TRIG:SOUR INT"
150 OUTPUT @Agte4991a;"INIT:CONT OFF"
160 OUTPUT @Agte4991a;"ABOR"
170 !
180 CALL Sweep(@Agte4991a)
190 !
200 END
210 !
220 SUB Sweep(@Agte4991a)
230 DIM Buff$[9]
240 INTEGER Swp_bool
250 !
260 OUTPUT @Agte4991a;"CALC:AVER?"
270 ENTER @Agte4991a;Swp_bool
280 IF Swp_bool=1 THEN OUTPUT @Agte4991a;"CALC:AVER:CLE"
290 !
300 OUTPUT @Agte4991a;"STAT:OPER:PTR 0"
310 OUTPUT @Agte4991a;"STAT:OPER:NTR 16"
320 OUTPUT @Agte4991a;"STAT:OPER:ENAB 16"
330 OUTPUT @Agte4991a;"*SRE 128"
340 OUTPUT @Agte4991a;"*CLS"
350 OUTPUT @Agte4991a;"*OPC?"
360 ENTER @Agte4991a;Buff$
370 !
380 ON INTR 7 GOTO Swp_end
390 ENABLE INTR 7;2
400 OUTPUT @Agte4991a;"INIT"
410 DISP "Now Measuring..."
420 Swp_wait: GOTO Swp_wait
430 Swp_end: DISP "Sweep Complete"
440 OFF INTR 7
450 SUBEND
```

### Example program using macro (E4991A VBA)

You are not able to use an SRQ in the macro program (E4991A VBA), which uses the **SingleMeasure method** instead of an SRQ. Example 5-2 shows an example program for detecting measurement end by using the **SingleMeasure method**. After setting the number of sweep averaging to 4, start a sweep by executing **SingleMeasure method**. **SingleMeasure method** waits until sweep has been completed. Then, when the sweep is completed, a message of completion is displayed, and the program ends. This program is saved under the filename sweep.bas on the sample programs disk. Below is an explanation of the details of the program.

Lines 50 - 60	Substitutes variables for the trace number and the number of sweep averaging.
Lines 100 - 130	Turns on Trace 1 and activates the sweep averaging function.
Lines 150 - 170	Sets the trigger source for the internal trigger and turns off the continuous activation of the trigger system. Then, resets the trigger system and sets the trigger sequence to the idle state.
Lines 190 - 200	Resets sweep averaging when the sweep averaging function is set to on.
Line 220	Starts the sweep and substitutes a variable of "bool" for sweep completion.

---

**NOTE**

---

When the sweep averaging function is set on, the measurement end is detected upon completion of the specified number of averaging.

Line 230	Displays a message of "Sweep Aborted" when sweep is aborted (bool=0) during the measurement.
Line 250	Stops the execution of the macro.

### Example 5-2

#### Detection of measurement end using the **SingleMeasure method**

```
10 Sub Sweep()  
20 Dim trc As Integer  
30 Dim swp_count As Integer, swp_bool As Integer, bool As  
Integer  
40  
50 trc = 1  
60 swp_count = 4  
70  
80 ' E4991A settings  
90  
100 SCPI.Output "*CLS"  
110 SCPI.Output "DISP:TRAC" & CStr(trc) & " ON"  
120 SCPI.Output "CALC:AVER:COUN " & CStr(swp_count)  
130 SCPI.Output "CALC:AVER ON"  
140  
150 SCPI.Output "TRIG:SOUR INT"  
160 SCPI.Output "INIT:CONT OFF"  
170 SCPI.Output "ABOR"  
180  
190 swp_bool = SCPI.Query("CALC:AVER?")  
200 If swp_bool = 1 Then SCPI.Output "CALC:AVER:CLE"  
210
```



## Measurement Start and Detection of Measurement End Example Programs for Detecting Measurement End

```
220     bool = SingleMeasure
230     If bool = 0 Then MsgBox ("Sweep Aborted")
240
250     End
260
270 End Sub
```

Measurement Start and Detection of Measurement End  
**Example Programs for Detecting Measurement End**

---

## **6 Read and Write Measurement Data**

This chapter explains how to read and write Agilent E4991A measurement data.

## Data Transfer Format

When a measurement condition setting is read from the E4991A, for example, when the **FREQ:STAR** command in the query format is used to read a sweep start frequency value, the ASCII format is used regardless of the data transfer format setting.

On the other hand, when simulation results of frequency characteristics are read during data measurement or equivalent circuit analysis, for example, when the **CALC{1-5}:DATA?** command is used to read a data trace array, either the ASCII (default) or binary format can be used. The binary formats include IEEE 32- and 64-bit floating point formats. Depending on the controller used, choose the appropriate format. Use the following GPIB command to select a data transfer format. When the binary format is selected, byte transfer order (byte order) can be specified.

- **FORM:DATA** on page 374

### ASCII Format

When data is read in the ASCII data transfer format, numeric values are transferred as ASCII bytes in one of the following formats. They are delimited by commas (,) in accordance with the IEEE488.2 specifications.

#### NOTE

Strings representing numeric values vary in length. Therefore, when each string is read from a comma-delimited list, commas do not appear in fixed positions.

- Integer Format

Figure 6-1 shows the integer format. A numeric value is represented as an integer. For example, a numeric 201 is expressed as “+201” or “201”.

Figure 6-1

### Integer Format

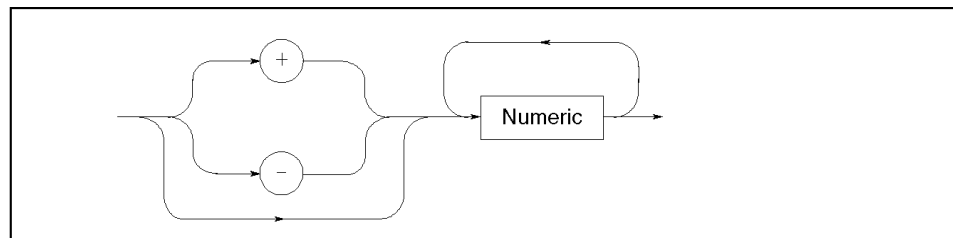

lb005013e

- Floating Point Format

Figure 6-2 shows the floating point format. A numeric value is represented as a floating point. For example, the numeric 1000 is expressed as “1.0E3”.

Figure 6-2

**Floating Point Format**

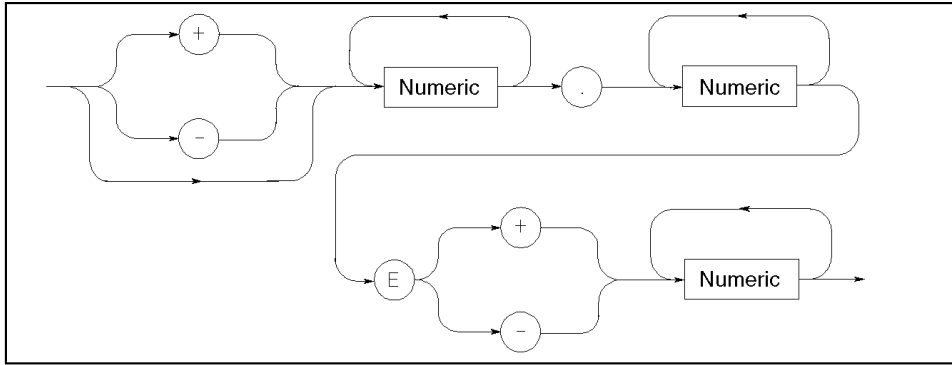

lb005015e

**IEEE 32-Bit Floating Point Format**

In this format, a numeric consists of four bytes. Therefore, assuming that one measurement point consists of two pieces of a numeric, when 201 measurement points are transferred, the total data length is 1608 bytes. A numeric is transferred into the format shown in Figure 6-3.

Figure 6-3

**IEEE 32-Bit Floating Point Data Transfer Format**

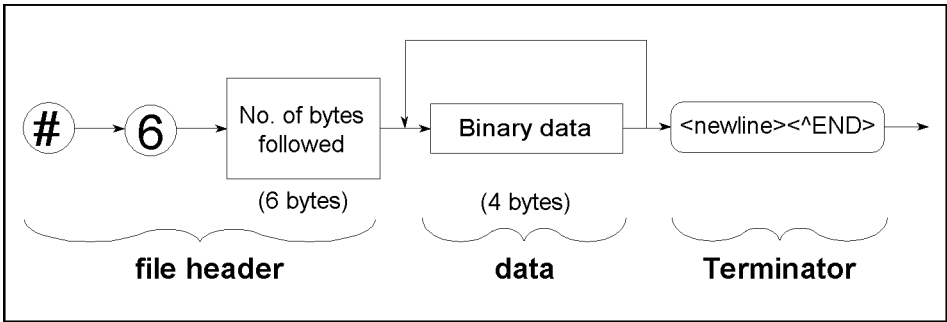

e4991ape033

### IEEE 64-Bit Floating Point Format

In this format, a numeric consists of eight bytes. Therefore, assuming that one measurement point consists of two pieces of a numeric, when 201 measurement points are transferred, the total data length is 3216 bytes. The numeric is transferred in the format shown in Figure 6-4.

Figure 6-4

IEEE 64-Bit Floating Point Data Transfer Format

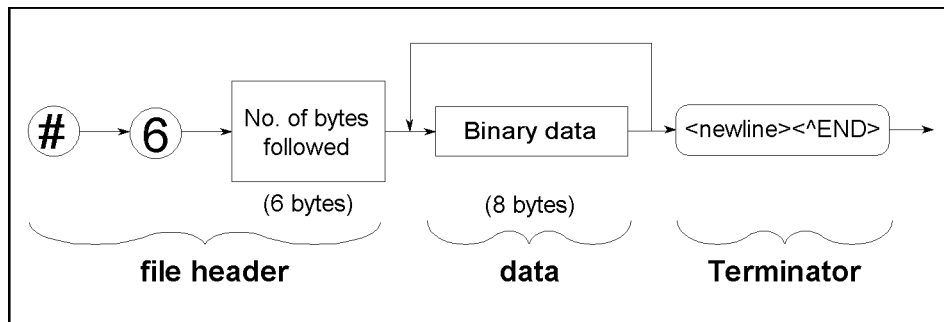

### Specify Byte Order (Binary Transfer)

When one of the binary formats is selected as the data transfer format, the following GPIB command can be used to specify the order in which each byte is transferred.

- **FORM:BORD** on page 373

For example, when data written in the IEEE 32-bit floating point format is read on a computer running MS-DOS, by reversing the order in which bytes are read with the above GPIB command, reformatting the data on the computer is not necessary.

## Internal Data Flow

### Data Processing Flow

Figure 6-5 shows an overview of the E4991A internal data processing flow.

**Figure 6-5** E4991A Data Processing Flow

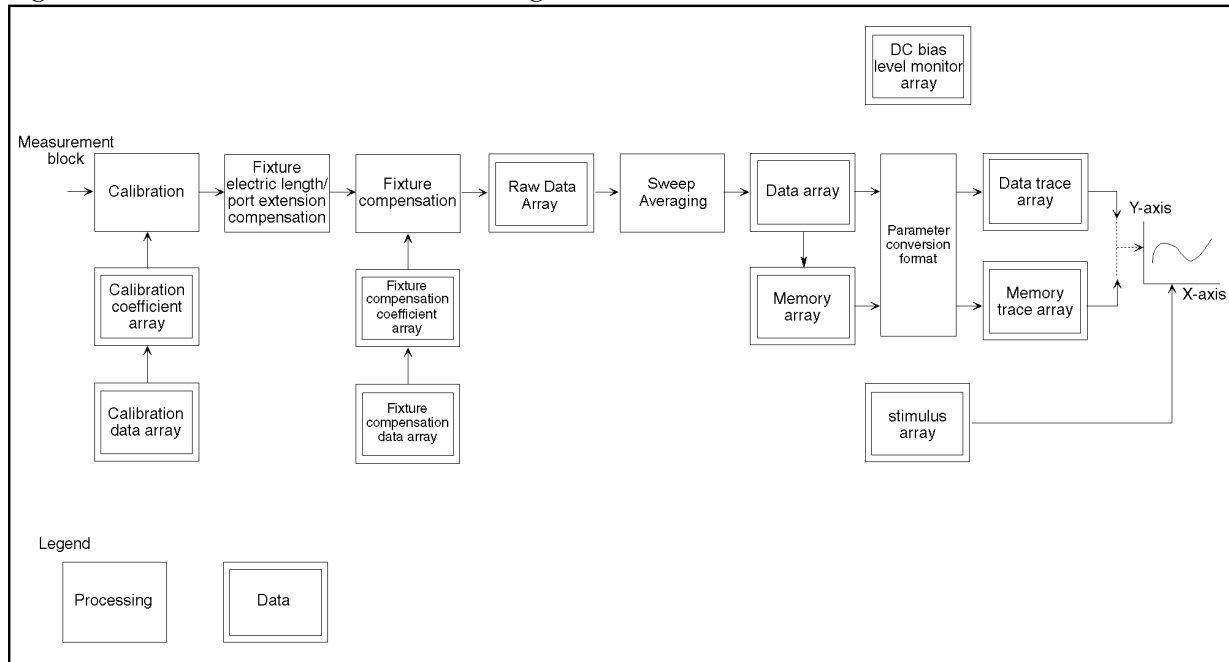

e4991ape018

The following section explains the internal data arrays shown in Figure 6-5.

### Internal Data Arrays

#### Raw Data Array

The raw data array contains the results of calibration, fixture electrical length/port extension compensation, and fixture compensation performed on the measured raw data. It is stored as a complex format (R-X). Use the following GPIB command to read the raw data array.

- **DATA:RAW?** on page 349

## Read and Write Measurement Data

### Internal Data Flow

#### Data Array

The data array contains the results of the sweep averaging performed on the raw data array. It is stored as a complex format (R-X).

Reading or writing the data array is not allowed.

#### Memory Array

The memory array contains the copied data array.

Reading or writing the memory array is not allowed.

#### Data Trace Array

The data trace array contains the number of measurement points of results obtained by measurement parameter conversion on the data array. For a scalar trace, results are stored in the real format, and for a complex trace, results are in the complex format. In addition, if data operations are performed between the data and memory trace arrays, the data trace array contains the results. Use the following GPIB command to read the data trace array.

- **CALC{1-5}:DATA?** on page 293

Writing the data trace array is not allowed.

#### Memory Trace Array

The memory trace array contains the number of measurement points of results obtained by measurement parameter conversion on the memory array. For a scalar trace, results are stored in the real format, and for a complex trace, results are in the complex format. In addition, when the equivalent circuit analysis function is used, the memory trace array contains the simulation results of frequency characteristics. Use the following GPIB command to read the memory trace array.

- **CALC{1-5}:DATA?** on page 293

Writing the memory trace array is not allowed.

#### Stimulus Array

The stimulus array contains stimulus values of all measurement points. Use the following GPIB command to read the stimulus array.

- **SWE:STIM{1-4}?** on page 512

Writing the stimulus array is not allowed.

#### DC Bias Level Monitor Array

The dc bias level monitor array contains dc bias voltage or current level monitor values in the real format. Use the following GPIB command to read the dc bias level monitor array.

- **CALC:DATA:MON?** on page 292

Writing the dc bias level monitor array is not allowed.



### Calibration Data Arrays

The calibration data arrays contain Open/Short/Load/Low-loss capacitor measurement data in the complex format. This data is used to calculate calibration coefficients. There are eight arrays containing Open/Short/Load/Low-loss capacitor measurement data.

Use the following GPIB command to read the calibration data array.

- **DATA:CAD{1-8}?** on page 345

When the sweep type is set to segment sweep, the following GPIB command can be used to read the calibration data array for each specified segment.

- **DATA:SEGM{1-16}:CAD{1-8}?** on page 350

Note that the above GPIB commands can be used to read a calibration data array measured with the calibration data measurement points of “User-defined frequency points and User-defined power points.”

Writing the calibration data array is not allowed.

Array number <sup>*1</sup>	Contained data
1	Open measurement data 1 for calculating calibration coefficients.
2	Short measurement data 1 for calculating calibration coefficients.
3	Load measurement data 1 for calculating calibration coefficients.
4	Low-loss capacitor measurement data 1 for calculating calibration coefficients.
5	Open measurement data 2 for calculating calibration coefficients.
6	Short measurement data 2 for calculating calibration coefficients.
7	Load measurement data 2 for calculating calibration coefficients.
8	Low-loss capacitor measurement data 2 for calculating calibration coefficients.

\*1. This number corresponds to the number specified at the end of the command.

### Calibration Coefficient Arrays

The calibration coefficient arrays contain calibration coefficients in the complex format. These were calculated using a calibration data array. As shown in the following table, there are six arrays containing calibration coefficients: A1, B1, C1, A2, B2, and C2.

Use the following GPIB command to read or write a calibration coefficient array.

- **DATA:CCO{1-6}** on page 346

For segment sweep, the following GPIB command can be used to read or write a calibration coefficient array for each specified segment.

- **DATA:SEGM{1-16}:CCO{1-6}** on page 351

Array number <sup>*1</sup>	Contained data
1	Calibration coefficient A1
2	Calibration coefficient B1
3	Calibration coefficient C1
4	Calibration coefficient A2
5	Calibration coefficient B2
6	Calibration coefficient C2

\*1. This number corresponds to the number specified at the end of the command.

---

#### NOTE

Before writing all of the calibration coefficient arrays, set the measurement frequency and oscillator level to the same values specified when they were read and enable the calibration function. Note that if calibration is disabled, it cannot be enabled until Open/Short/Load calibration data are measured. Therefore, calibration data must be measured before calibration coefficient arrays are written. However, measuring actual calibration data is not necessary. Accordingly, you can measure calibration data without connecting a calibration standard and then enable calibration.

After performing measurement using the written calibration coefficient arrays, if stimulus values are changed, the calibration coefficient arrays are written again, resulting in incorrect measurement regardless of whether calibration is enabled or disabled.

---

### Fixture Compensation Data Arrays

The fixture compensation data array contains Open/Short measurement data in the complex format. This data is used to calculate fixture compensation coefficients. There are two arrays containing Open/Short measurement data.

Use the following GPIB command to read the fixture compensation data array.

- **DATA:CMD{1-2}?** on page 347

When the sweep type is set to segment sweep, the following GPIB command can be used to read the fixture compensation data array for each specified segment.

- **DATA:SEGM{1-16}:CMD{1-2}?** on page 352

Note that the above GPIB commands can be used to read fixture compensation data arrays measured with the fixture compensation data measurement points of “User-defined frequency points” and “User-defined power points.”

Writing the fixture compensation data array is not allowed.

Array number <sup>*1</sup>	Contained data
1	Open measurement data for calculating fixture compensation coefficients.
2	Short measurement data for calculating fixture compensation coefficients.

\*1. This number corresponds to the number specified at the end of the command.

### Fixture Compensation Coefficient Arrays

The fixture compensation coefficient array contains fixture compensation coefficients in the complex format. These were calculated using a fixture compensation data array. As shown in the following table, there are three arrays containing fixture compensation coefficients A, B, and C.

Use the following GPIB command to read or write a fixture compensation coefficient array.

- **DATA: CMP{1-3}** on page 348

When the sweep type is set to segment sweep, use the following GPIB command to read or write a fixture compensation coefficient array.

- **DATA: SEGM{1-16}: CMP{1-3}** on page 353

Array number <sup>*1</sup>	Contained data
1	Fixture Compensation coefficient A
2	Fixture Compensation coefficient B
3	Fixture Compensation coefficient C

\*1. This number corresponds to the number specified at the end of the command.

---

#### NOTE

Before writing all of the fixture compensation coefficient arrays, set the measurement frequency and oscillator level to the same values specified when they were read and enable the fixture compensation function. Note that if fixture compensation is disabled, it cannot be enabled until Open/Short fixture compensation data is measured. Therefore, fixture compensation data must be measured before fixture compensation coefficient arrays are written. However, measuring actual fixture compensation data is not necessary. Accordingly, you can measure fixture compensation data without connecting a fixture compensation standard and then enable fixture compensation.

After performing measurement using the written fixture compensation coefficient arrays, if stimulus values are changed, or if fixture compensation is switched between enabled and disabled, the fixture compensation arrays are written again, resulting in incorrect measurement regardless of whether fixture compensation is enabled or disabled.

---

### Timing for read/write

When a read command is executed during a sweep, the data at the time the command is executed is read. Therefore, in order to obtain correct measured data, it is necessary to execute the command for data read after waiting for the completion of the sweep. In cases in which the program execution speed is considered, the read command should be synchronized with the completion of the sweep and executed upon its completion. In order to synchronize with the completion of the sweep, use the status report system. Refer to “Example Programs for Detecting Measurement End” on page 114 for details.

## Example Programs for Reading Internal Data Arrays

### Reading the data trace array (ASCII format)

An example program for reading the data trace array is shown. In the program, the data trace array is read in ASCII transfer format.

#### Example program using HTBasic

The program shown in Example 6-1 is saved under the filename `asc_read.htb` on the sample programs disk. Below is an explanation of the program's details.

Line 50	Sets the GPIB address
Lines 70 - 80	Substitutes variables for the trace number and measurement point.
Line 120	Resets the E4991A.
Lines 140 - 150	Turns on Trace 1 and sets the measurement point.
Lines 170 - 190	Sets the trigger source to the internal trigger and turns off the continuous activation of the trigger system. Then, it resets the trigger system, and sets the trigger sequence to the idle state.
Line 210	Calls the sub-program that executes a sweep.
Line 230	Executes auto-scale adjustment of the trace.
Line 250	Sets the data transfer format to ASCII transfer format.
Lines 270 - 300	Reads the data trace array and stimulus array.
Lines 340 - 570	Refer to "Example Programs for Detecting Measurement End" on page 114 for an explanation of the sub-program.

#### Example 6-1

#### Reading the data trace array

```

10  DIM Meas_data(1:201),Swp_prm(1:201)
20  INTEGER Trc1,Nop
30  !
40  CLEAR SCREEN
50  ASSIGN @Agte4991a TO 717
60  !
70  Trc1=1
80  Nop=201
90  !
100 ! E4991A settings
110 !
120 OUTPUT @Agte4991a;"SYST:PRES"
130 !
140 OUTPUT @Agte4991a;"DISP:TRAC"&VAL$(Trc1) & " ON"
150 OUTPUT @Agte4991a;"SWE:POIN "&VAL$(Nop)
160 !
170 OUTPUT @Agte4991a;"TRIG:SOUR INT"
180 OUTPUT @Agte4991a;"INIT:CONT OFF"
190 OUTPUT @Agte4991a;"ABOR"
200 !
210 CALL Sweep(@Agte4991a)

```

## Read and Write Measurement Data

### Example Programs for Reading Internal Data Arrays

```
220      !
230      OUTPUT @Agte4991a;"DISP:TRAC"&VAL$(Trc1)&":Y:AUTO"
240      !
250      OUTPUT @Agte4991a;"FORM:DATA ASC"
260      !
270      OUTPUT @Agte4991a;"CALC"&VAL$(Trc1)&":DATA? FDATA"
280      ENTER @Agte4991a;Meas_data(*)
290      OUTPUT @Agte4991a;"SWE:STIM1?"
300      ENTER @Agte4991a;Swp_prm(*)
310      !
320      END
330      !
340      SUB Sweep(@Agte4991a)
350          DIM Buff$(9)
360          INTEGER Swp_bool
370          !
380          OUTPUT @Agte4991a;"CALC:AVER?"
390          ENTER @Agte4991a;Swp_bool
400          IF Swp_bool=1 THEN OUTPUT @Agte4991a;"CALC:AVER:CLE"
410          !
420          OUTPUT @Agte4991a;"STAT:OPER:PTR 0"
430          OUTPUT @Agte4991a;"STAT:OPER:NTR 16"
440          OUTPUT @Agte4991a;"STAT:OPER:ENAB 16"
450          OUTPUT @Agte4991a;"*SRE 128"
460          OUTPUT @Agte4991a;"*CLS"
470          OUTPUT @Agte4991a;"*OPC?"
480          ENTER @Agte4991a;Buff$
490          !
500          ON INTR 7 GOTO Swp_end
510          ENABLE INTR 7;2
520          OUTPUT @Agte4991a;"INIT"
530          DISP "Now Measuring..."
540      Swp_wait: GOTO Swp_wait
550      Swp_end: DISP "Sweep Complete"
560          OFF INTR 7
570      SUBEND
```

**Example program using macro (E4991A VBA)**

The program shown in Example 6-2 is saved under the filename asc\_read.bas on the sample programs disk. Below is an explanation of the program's details.

Lines 60 - 70	Substitutes variables for the trace number and number of measurement points.
Line 110	Resets the E4991A.
Lines 130 - 140	Turns on Trace 1 and sets the measurement point.
Lines 160 - 180	Sets the trigger source to the internal trigger and turns off the continuous activation of the trigger system. Then, it resets the trigger system and sets the trigger sequence to the idle state.
Lines 200 - 210	Resets the sweep averaging when sweep averaging function is set to on.
Line 230	Starts the sweeps and substitutes a variable of "bool" for sweep completion.
Lines 250 - 260	Displays a message of "Sweep Aborted" when sweep is aborted (bool=0) during the measurement.
Line 270	Describes the program routine below this line when sweep is completed without problem (bool=1).
Line 280	Executes auto-scale adjustment of the trace.
Line 300	Sets the data transfer format to ASCII transfer format.
Lines 320 - 350	Reads the data trace array and stimulus array.
Lines 340 - 570	Stops execution of the macro.

**Example 6-2**

**Read of the data trace array**

```

10      Sub Main()
20          Dim meas_data As Variant, swp_prm As Variant
30          Dim trc1 As Integer, nop As Integer
40          Dim swp_bool As Integer, bool As Integer
50
60          trc1 = 1
70          nop = 201
80
90          ' E4991A settings
100
110         SCPI.Output "SYST:PRES"
120
130         SCPI.Output "DISP:TRAC" & CStr(trc1) & " ON"
140         SCPI.Output "SWE:POIN " & CStr(nop)
150
160         SCPI.Output "TRIG:SOUR INT"
170         SCPI.Output "INIT:CONT OFF"
180         SCPI.Output "ABOR"
190
200         swp_bool = SCPI.Query("CALC:AVER?")
210         If swp_bool = 1 Then SCPI.Output "CALC:AVER:CLE"
220
230         bool = SingleMeasure
240

```

## Read and Write Measurement Data

### Example Programs for Reading Internal Data Arrays

```
250     If bool = 0 Then
260         MsgBox ("Sweep Aborted")
270     ElseIf bool = 1 Then
280         SCPI.Output "DISP:TRAC" & CStr(trc1) & ":Y:AUTO"
290
300         SCPI.Output "FORM:DATA ASC"
310
320         SCPI.Output "CALC" & CStr(trc1) & ":DATA? FDATA"
330         SCPI.Enter meas_data, "#"
340         SCPI.Output "SWE:STIM3?"
350         SCPI.Enter swp_prm, "#"
360     End If
370
380     End
390 End Sub
```



## Reading the dc bias level monitor array

By using the dc bias monitor function, the example program shown below can read the monitor value at each measurement point.

### Example program using HTBasic

The dc bias monitor value taken during the dc bias voltage sweep is read in binary transfer format (IEEE 64-bit floating-point) and the results are displayed. The program shown in Example 6-3 is saved under the filename `bias_mon.htb` on the sample programs disk. Below is an explanation of the program's details.

Lines 100 - 110	Sets the GPIB address.
Lines 130 - 210	Substitutes variables for the trace number, dc bias voltage sweep range, number of measurement points, sweep averaging factor, and CW frequency and level value of the signal source.
Line 250	Resets the E4991A.
Lines 270 - 290	Turns on Trace 1 and sets the measurement parameter to impedance. In addition, turns off Trace 2.
Lines 310 - 380	Sets the sweep parameter for the dc bias voltage sweep. Next, sets the sweep range, number of measurement points, sweep direction, and sweep averaging function.
Lines 400 - 420	Sets the CW frequency of the signal source, the mode of the oscillator level, and the level value.
Lines 440 - 450	Turns on the dc bias output and the monitor function. However, when using the monitor function, due to the necessity of setting the marker function in advance, marker 1 is set on.
Lines 480 - 500	Sets the trigger source in the internal trigger and turns off the continuous activation of the trigger system. Then, resets the trigger system and sets the trigger sequence to the idle state.
Line 520	Calls the sub-program to execute a sweep.
Line 540	Sets the data transfer format to IEEE 64-bit floating-point format.
Lines 560 - 590	Reads out the data trace array.
Lines 610 - 640	Reads out the dc bias level monitor array.
Lines 660 - 690	Reads out the stimulus array.
Lines 710 - 770	Displays the measurement values and the dc bias monitor values.
Lines 810 - 1040	Refer to "Example Programs for Detecting Measurement End" on page 114 for an explanation of the sub-program.

### Example 6-3

#### Reading the monitor value

```

10   DIM Meas_data(1:41),Mon_bias(1:41),Swp_prm(1:41)
20   DIM Header$(9),Buff$(9),Img$(30)
30   DIM Start_bias$(9),Stop_bias$(9),Lim_bias$(9)
40   DIM Cw_freq$(9),Osc_level$(9)
50   INTEGER Trc1,Trac2,Nop,Swp_count,I
70   !
80   CLEAR SCREEN

```

## Read and Write Measurement Data

### Example Programs for Reading Internal Data Arrays

```
90      !
100     ASSIGN @Agte4991a TO 717
110     ASSIGN @Binary TO 717;FORMAT OFF
120     !
130     Trc1=1
140     Trc2=2
150     Start_bias$="0V"
160     Stop_bias$="40V"
170     Lim_bias$="50MA"
180     Nop=41
190     Swp_count=1
200     Cw_freq$="100MHZ"
210     Osc_level$="0.1V"
220     !
230     ! E4991A settings
240     !
250     OUTPUT @Agte4991a;"SYST:PRES"
260     !
270     OUTPUT @Agte4991a;"DISP:TRAC"&VAL$(Trc1)&" ON"
280     OUTPUT @Agte4991a;"DISP:TRAC"&VAL$(Trc2)&" OFF"
290     OUTPUT @Agte4991a;"CALC"&VAL$(Trc1)&":FORM Z"
300     !
310     OUTPUT @Agte4991a;"SWE:TYPE DCV"
320     OUTPUT @Agte4991a;"SOUR:VOLT:OFFS:STAR "&Start_bias$
330     OUTPUT @Agte4991a;"SOUR:VOLT:OFFS:STOP "&Stop_bias$
340     OUTPUT @Agte4991a;"SOUR:CURR:LIM:OFFS "&Lim_bias$
350     OUTPUT @Agte4991a;"SWE:POIN "&VAL$(Nop)
360     OUTPUT @Agte4991a;"SWE:DIR UP"
370     OUTPUT @Agte4991a;"CALC:AVER:COUN "&VAL$(Swp_count)
380     OUTPUT @Agte4991a;"CALC:AVER ON"
390     !
400     OUTPUT @Agte4991a;"FREQ "&Cw_freq$
410     OUTPUT @Agte4991a;"SOUR:VOLT:MODE FIX"
420     OUTPUT @Agte4991a;"SOUR:VOLT "&Osc_level$
430     !
440     OUTPUT @Agte4991a;"SOUR:VOLT:OFFS:STAT ON"
450     OUTPUT @Agte4991a;"CALC"&VAL$(Trc1)&":MARK1 ON"
460     OUTPUT @Agte4991a;"CALC:BMON ON"
470     !
480     OUTPUT @Agte4991a;"TRIG:SOUR INT"
490     OUTPUT @Agte4991a;"INIT:CONT OFF"
500     OUTPUT @Agte4991a;"ABOR"
510     !
520     CALL Sweep(@Agte4991a)
530     !
540     OUTPUT @Agte4991a;"FORM:DATA REAL,64"
550     !
560     OUTPUT @Agte4991a;"CALC"&VAL$(Trc1)&":DATA? FDATA"
570     ENTER @Agte4991a USING "#,8A";Header$
580     ENTER @Binary;Meas_data(*)
590     ENTER @Agte4991a USING "#,1A";Buff$
600     !
610     OUTPUT @Agte4991a;"CALC:DATA:MON? V"
620     ENTER @Agte4991a USING "#,8A";Header$
630     ENTER @Binary;Mon_bias(*)
640     ENTER @Agte4991a USING "#,1A";Buff$
650     !
660     OUTPUT @Agte4991a;"SWE:STIM3?"
```

```

670  ENTER @Agte4991a USING "#,8A";Header$
680  ENTER @Binary;Swp_prm(*)
690  ENTER @Agte4991a USING "#,1A";Buff$
700  !
710  PRINT "BIAS MONITOR RESULT"
720  PRINT
730  PRINT "DC Bias[V]          Z[ohm]          Mon Bias[V]"
740  PRINT "-----"
750  FOR I=1 TO Nop
760    PRINT Swp_prm(I),Meas_data(I),Mon_bias(I)
770  NEXT I
780  !
790  END
800  !
810  SUB Sweep(@Agte4991a)
820    DIM Buff$(9)
830    INTEGER Swp_bool
840    !
850    OUTPUT @Agte4991a;"CALC:AVER?"
860    ENTER @Agte4991a;Swp_bool
870    IF Swp_bool=1 THEN OUTPUT @Agte4991a;"CALC:AVER:CLE"
880    !
890    OUTPUT @Agte4991a;"STAT:OPER:PTR 0"
900    OUTPUT @Agte4991a;"STAT:OPER:NTR 16"
910    OUTPUT @Agte4991a;"STAT:OPER:ENAB 16"
920    OUTPUT @Agte4991a;"*SRE 128"
930    OUTPUT @Agte4991a;"*CLS"
940    OUTPUT @Agte4991a;"*OPC?"
950    ENTER @Agte4991a;Buff$
960    !
970    ON INTR 7 GOTO Swp_end
980    ENABLE INTR 7;2
990    OUTPUT @Agte4991a;"INIT"
1000   DISP "Now Measuring..."
1010 Swp_wait: GOTO Swp_wait
1020 Swp_end: DISP "Sweep Complete"
1030   OFF INTR 7
1040   SUBEND

```

## Read and Write Measurement Data

### Example Programs for Reading Internal Data Arrays

#### Example program using macro (E4991A VBA)

The dc bias monitor value at the time of the dc bias voltage sweep is read in ASCII transfer format and the results are saved to a specified file. When using a macro, you cannot select a binary transfer format. The program shown in Example 6-4 is saved under the filename bias\_mon.bas on the sample programs disk. Below is an explanation of the program's details.

Lines 110 - 190	Substitutes variables for the trace number, dc bias voltage sweep range, number of measurement points, sweep averaging factor, and CW frequency and level value of the signal source.
Line 230	Resets the E4991A.
Lines 250 - 270	Turns on Trace 1 and sets the measurement parameter to impedance. In addition, turns off Trace 2.
Lines 290 - 360	Sets the sweep parameter for the dc bias voltage sweep. Next, sets the sweep range, number of measurement points, sweep direction, and sweep averaging function.
Lines 380 - 400	Sets the CW frequency of the signal source, the mode of the oscillator level, and the level value.
Lines 420 - 440	Turns on the dc bias output and the monitor function. However, when using the monitor function, due to the necessity of setting the marker function in advance, marker 1 is set on.
Lines 460 - 480	Sets the trigger source in the internal trigger and turns off the continuous activation of the trigger system. Then, resets the trigger system and sets the trigger sequence to the idle state.
Lines 500 - 510	Resets the sweep averaging when sweep averaging function is set to on.
Line 530	Starts the sweep and substitutes a variable of "bool" for sweep completion.
Lines 540 - 550	Displays a message of "Sweep Aborted" when sweep is aborted (bool=0) during the measurement.
Line 560	Describes the program routine below this line when sweep is completed without problem (bool=1).
Line 570	Sets the data transfer format to ASCII format.
Lines 590 - 600	Reads out the data trace array.
Lines 610 - 620	Reads out the dc bias level monitor array.
Lines 630 - 640	Reads out the stimulus array.
Lines 660 - 760	Saves the measurement values and the dc bias monitor values to the specified file.
Lines 790	Stops execution of the macro.

#### Example 6-4

#### Reading the monitor value

```
10      Sub Main()  
20          Dim meas_data As Variant, mon_bias As Variant, swp_prm As  
Variant  
30          Dim header As String, buff As String, img As String
```

```

40      Dim start_bias As Double, stop_bias As Double, lim_bias As
Double
50      Dim cw_freq As Double, osc_level As Double
60      Dim trc1 As Integer, trc2 As Integer, nop As Integer,
swp_count As Integer
70      Dim i As Integer, swp_bool As Integer, bool As Integer
80      Dim fileNum As Integer
90      Dim file As String
100
110     trc1 = 1
120     trc2 = 2
130     start_bias = 0
140     stop_bias = 40
150     lim_bias = 0.05
160     nop = 41
170     swp_count = 1
180     cw_freq = 100000000#
190     osc_level = 0.1
200
210     ' E4991A settings
220
230     SCPI.Output "SYST:PRES"
240
250     SCPI.Output "DISP:TRAC" & CStr(trc1) & " ON"
260     SCPI.Output "DISP:TRAC" & CStr(trc2) & " OFF"
270     SCPI.Output "CALC" & CStr(trc1) & ":FORM Z"
280
290     SCPI.Output "SWE:TYPE DCV"
300     SCPI.Output "SOUR:VOLT:OFFS:STAR " & CStr(start_bias)
310     SCPI.Output "SOUR:VOLT:OFFS:STOP " & CStr(stop_bias)
320     SCPI.Output "SOUR:CURR:LIM:OFFS " & CStr(lim_bias)
330     SCPI.Output "SWE:POIN " & CStr(nop)
340     SCPI.Output "SWE:DIR UP"
350     SCPI.Output "CALC:AVER:COUN " & CStr(swp_count)
360     SCPI.Output "CALC:AVER ON"
370
380     SCPI.Output "FREQ " & CStr(cw_freq)
390     SCPI.Output "SOUR:VOLT:MODE FIX"
400     SCPI.Output "SOUR:VOLT " & CStr(osc_level)
410
420     SCPI.Output "SOUR:VOLT:OFFS:STAT ON"
430     SCPI.Output "CALC" & CStr(trc1) & ":MARK1 ON"
440     SCPI.Output "CALC:BMON ON"
450
460     SCPI.Output "TRIG:SOUR INT"
470     SCPI.Output "INIT:CONT OFF"
480     SCPI.Output "ABOR"
490
500     swp_bool = SCPI.Query("CALC:AVER?")
510     If swp_bool = 1 Then SCPI.Output "CALC:AVER:CLE"
520
530     bool = SingleMeasure
540     If bool = 0 Then
550         MsgBox ("Sweep Aborted")
560     ElseIf bool = 1 Then
570         SCPI.Output "FORM:DATA ASC"
580
590         SCPI.Output "CALC" & CStr(trc1) & ":DATA? FDATA"

```

## Read and Write Measurement Data

### Example Programs for Reading Internal Data Arrays

```
600         SCPI.Enter meas_data, "#"
610         SCPI.Output "CALC" & CStr(trc1) & ":DATA:MON? V"
620         SCPI.Enter mon_bias, "#"
630         SCPI.Output "SWE:STIM3?"
640         SCPI.Enter swp_prm, "#"
650
660         file = "a:\mon_data.txt"
670         fileNum = FreeFile
680         Open file For Output As #fileNum
690         Print #fileNum, "Bias Monitor Result"
700         Print #fileNum, ""
710         Print #fileNum, "DC Bias[V]      Z[ohm]
Mon. Bias[V]"
720         Print #fileNum,
"-----"
730         For i = 1 To nop
740             Print #fileNum, Val(swp_prm(i - 1)), Val(meas_data(i -
1)), Val(mon_bias(i - 1))
750         Next i
760         Close #fileNum
770     End If
780
790     End
800 End Sub
```

---

**7****Measurement Result Processing**

This chapter explains how to process measurement results by using the Agilent E4991A's marker function and equivalent circuit analysis function.

## Using Marker Function

### Markers

#### Turning On/Off Markers

Markers must first be displayed on a specified trace before the marker function can be used. The E4991A allows you to display up to nine markers (markers 1-8 and a reference marker) on one trace.

Use the following GPIB command to turn on/off Markers 1-8.

- **CALC{1-5}:MARK{1-8}** on page 304

Use the following GPIB command to turn on/off the reference marker (Marker R).

- **CALC{1-5}:MARK:REF** on page 328

The following GPIB command can be used to erase all of the markers on the specified trace.

- **CALC{1-5}:MARK:AOFF** on page 305

#### Setting the Active Marker

When the marker function is performed with the active marker, it is necessary to set the specified marker to the active marker. If a marker number or the reference marker is not specified in a GPIB command, the command is usually performed on the active marker.

Use the following GPIB command to set one of markers 1-8 as the active marker.

- **CALC{1-5}:MARK{1-8}:ACT** on page 305

Use the following GPIB command to set the reference marker as the active marker.

- **CALC{1-5}:MARK:REF:ACT** on page 329



### Selecting Trace for Which Markers Are Displayed

Use the following GPIB command to select whether markers are displayed on a data trace or a memory trace.

- **CALC{1-5}:MARK:ON** on page 327

### Displaying Marker List

Use the following GPIB command to display a list of all markers on the screen.

- **CALC{1-5}:MARK:LIST** on page 326

### Moving Markers and Reading at Marker Positions

#### Switching between Continuous Marker and Discontinuous Marker Modes

Use the following GPIB command to select whether a marker can move only to measurement points on a trace or can move to anywhere regardless of measurement points.

- **CALC{1-5}:MARK:DISC** on page 309

#### Switching Marker Couple Modes

Use the following GPIB command to select whether marker display and movement as well as X-axis value setting are coupled with all of the traces or applied only to individual traces.

- **CALC:MARK:COUP** on page 309

#### Selecting Unit of Stimulus Value at Marker Position

The following GPIB command can be used to select the unit of a stimulus value at a marker position from measurement parameters, time, and relaxation time.

- **CALC{1-5}:MARK:UNIT** on page 337

#### Setting and Reading Stimulus Value at Marker Position

Use the following GPIB command to select a marker from 1-8 and move the specified marker to any stimulus value. If this command is executed in the query format, the stimulus value at the marker position is read.

- **CALC{1-5}:MARK{1-8}:X** on page 338

Use the following GPIB command to move the reference marker to any stimulus value. If this command is executed in the query format, the stimulus value at the reference marker position is read.

- **CALC{1-5}:MARK:REF:X**

## Measurement Result Processing Using Marker Function

### Reading Measurement Value at Marker Position

The following GPIB command can be used to select a marker from 1-8 and read the measurement value at the specified marker position.

- **CALC{1-5}:MARK{1-8}:Y?** on page 339

The following GPIB command can be used to read the measurement value at the reference marker position.

- **CALC{1-5}:MARK:REF:Y** on page 335

### Selecting Measurement Value Format (Complex Trace)

For markers on a scalar trace, a measurement value at the marker position is read based on the measurement parameter selected by the **CALC{1-5}:FORM** command. For markers on a complex trace, a measurement value at the marker position is read in the format selected by the following GPIB command.

- **CALC{4-5}:MARK:FORM** on page 310

### Setting $\Delta$ Mode

In a marker's  $\Delta$  mode, the instrument reads the deviation between stimulus values at the specified marker position and at the reference marker as well as the deviation between measurement values at the specified marker position and at the reference marker.

### Selecting Reference Marker Mode

The following GPIB command can be used to select either the  $\Delta$  mode, where the reference marker is set to a stimulus value on the current trace, or the fixed  $\Delta$  mode, where the reference marker is set to both the current stimulus and the measurement value.

- **CALC{1-5}:MARK:REF:TYPE** on page 333

### Setting and Reading Measurement Value at Reference Marker Position (Fixed $\Delta$ Mode)

If the fixed  $\Delta$  mode is selected, the following GPIB command can be used to move the reference marker to the specified measurement value. If this command is executed in the query format, the measurement value at the current reference marker position is read.

- **CALC{1-5}:MARK:REF:Y** on page 335

For a complex trace, move the reference marker to the specified measurement value by first specifying the measurement value with the real and imaginary part of the complex.

## Entering Marker Values as E4991A Setting

The stimulus value or measurement value at an active marker position can be used as the E4991A internal setting as follows.

- The stimulus value at an active marker position is entered as the center value of the sweep range.
- The range between the stimulus values at an active marker and a  $\Delta$  marker is entered as the span value of the sweep range if the  $\Delta$  marker mode is enabled.
- The stimulus value at an active marker position is entered as the start value of the sweep range.
- The stimulus value at an active marker position is entered as the stop value of the sweep range.
- The measurement value at an active marker position is entered as a reference value on the Y-axis scale.
- For a scalar trace, a measurement value at an active marker position is entered as the offset by which a data trace value is subtracted.

Use the following GPIB command to enter the stimulus value or measurement value at an active marker position as the E4991A setting.

- **CALC{1-5}:MARK:SET** on page 336

## Marker Search Function

The marker search function allows you to search for a certain point on a trace and have the active marker move to that point.

### Selecting Points to Search for

The marker search function can be used to search for the following points on a trace.

- Maximum value
- Minimum value
- Positive peak value
- Negative peak value
- Target value

Use the following GPIB command to select the point to search for.

- **CALC{1-5}:MARK:FUNC:EXEC** on page 321

### Partial Search Function

Normally, a marker search is performed within the entire sweep range. On the other hand, the partial search function can be used to perform marker search within the specified range. Use the following GPIB command to turn on/off the partial search function.

- **CALC{1-5}:MARK:FUNC:DOM** on page 312

If the partial search function is performed, use the following GPIB command to specify the left and right ends of the search range.

- **CALC{1-5}:MARK:FUNC:DOM:STAR** on page 320
- **CALC{1-5}:MARK:FUNC:DOM:STOP** on page 320

Use the following GPIB command to specify the range between an active marker and the reference marker as a search range.

- **CALC{1-5}:MARK:FUNC:DOM:SPAN** on page 319

**Defining a Target**

The marker’s target search function can be used to search for a specified target. Use the following GPIB command to specify a target value.

- **CALC{1-5}:MARK:FUNC:TARG** on page 324

**Defining a Peak**

The marker’s peak search function searches for the maximum value (positive peak value) or minimum value (negative peak value) that agrees with the definitions shown in Figure 7-1. Use the following GPIB command to define peaks.

- **CALC{1-5}:MARK:APE:EXC:X** on page 307
- **CALC{1-5}:MARK:APE:EXC:Y** on page 308

The following GPIB command can be used to define a peak based on the stimulus value and the measurement value at an active marker position.

- **CALC{1-5}:MARK:APE:SET** on page 306

Figure 7-1

**Peak Definition in Marker Search**

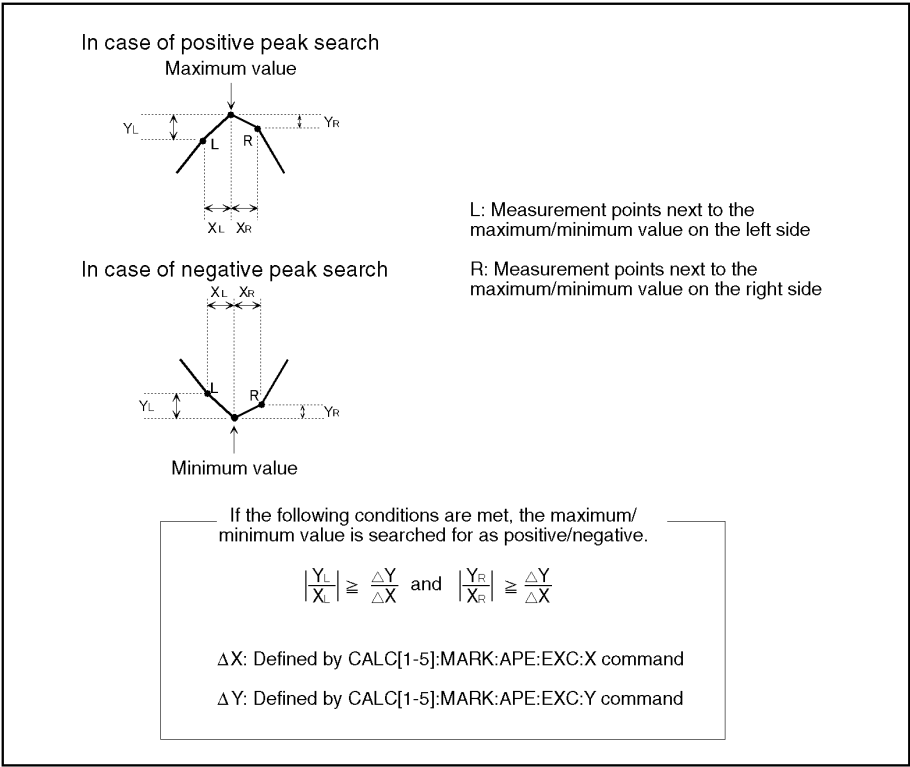

e4991ape014

### Performing Marker Search

The following GPIB command can be used to perform marker search only once for a specified target on a specified trace. When the specified target is found, the active marker moves to that point.

- **CALC{1-5}:MARK:FUNC:EXEC** on page 321

When the **CALC{1-5}:MARK:FUNC** command is used to select a target, the positive peak, or the negative peak to search for, the following GPIB command can be used to perform marker search only once for a target or a peak on the right or left side of the current active marker.

- **CALC{1-5}:MARK:FUNC:EXEC:RIGH** on page 323
- **CALC{1-5}:MARK:FUNC:EXEC:LEFT** on page 322

During positive/negative peak search, the following GPIB command can be used to search for the next highest peak.

- **CALC{1-5}:MARK:FUNC:EXEC:NEXT** on page 322

### Repeating Marker Search (Tracking Function)

To perform marker search automatically for each sweep, use the following GPIB command to turn on/off the tracking function.

- **CALC{1-5}:MARK:FUNC:TRAC** command on page 325

Once tracking is enabled, the marker search function is performed for a target on the trace specified with the following GPIB command.

- **CALC{1-5}:MARK:FUNC** on page 311

### Reading Marker Search Results by Using the Status Report System

You can read the marker search results for a specified trace by using the status report system. See Table B-7, “Status Bit Definition of Questionable Status Search Event Register,” on page 563 for more information.

## Limit Test Function

The marker's limit test function can be used to determine whether the measurement value at the marker position specified as the test marker falls within the range of the test limit.

### Setting Test Marker

Before performing limit tests, the following GPIB command must be used to select one of markers 1-8 as the test marker.

- **CALC{1-5}:MARK{1-8}:FUNC:DOM:LIM** on page 313

The following GPIB command can be used to select the reference marker as the test marker.

- **CALC{1-5}:MARK:REF:FUNC:DOM:LIM** on page 329

### Setting Test Limits

Before performing a limit test, the upper and lower limits of the test must be specified.

If one of the markers 1-8 is selected as the test marker, use the following GPIB commands to set the upper and lower limits of the limit test.

- **CALC{1-5}:MARK{1-8}:FUNC:DOM:LIM:UP** on page 318
- **CALC{1-5}:MARK{1-8}:FUNC:DOM:LIM:LOW** on page 316

If the reference marker is selected as the test marker, use the following GPIB commands to set the upper and lower limits of the limit test.

- **CALC{1-5}:MARK:REF:FUNC:DOM:LIM:UP** on page 332
- **CALC{1-5}:MARK:REF:FUNC:DOM:LIM:LOW** on page 330

---

#### NOTE

When the limit test function is performed on a complex trace, the real part of the measurement data on the specified marker is compared with the test limits.

---

### Turning On/Off Limit Test Function

Use the following GPIB command to turn on/off the limit test function.

- **CALC{1-5}:MARK:FUNC:DOM:LIM:ALL** on page 314

## Measurement Result Processing Using Marker Function

### Reading Limit Test Results

Limit test results can be read in two ways: Reading the test result of a specified test marker or reading the overall evaluation results of all test markers (that is, the test results for all of the test markers are logically ANDed).

Use the following GPIB command to read the test result of a specified test marker (1-8).

- **CALC{1-5}:MARK{1-8}:FUNC:DOM:LIM:RES?** on page 317

If the reference marker is selected as a test marker, the following GPIB command can be used to read a limit test result.

- **CALC{1-5}:MARK:REF:FUNC:DOM:LIM:RES?** on page 331

The following GPIB command can be used to read the overall evaluation results of the limit tests of all test markers (that is, the test results for all of the test markers are logically ANDed).

- **CALC{1-5}:MARK:FUNC:DOM:LIM:ALL:RES?** on page 315

### Reading Limit Test Results by Using Status Report System

You can read the limit test results by using the status report system. See Table B-6, “Status Bit Definition of Questionable Status Limit Event Register,” on page 562 for more information.

### Combining Limit Test and $\Delta$ Mode

Limit tests can also be performed on the deviation between measurement values at the reference marker and those at any other marker. To do this, select the reference marker as a test marker and use the following GPIB command to set the mode to  $\Delta$  or fixed  $\Delta$ .

- **CALC{1-5}:MARK:REF:TYPE** on page 333

### Displaying Test Conditions and Test Results for Each Marker

The following GPIB command can be used to display test conditions of a limit test and test results for each marker.

- **DISP:TEXT{1-3}:SET** on page 356



## Statistical Analysis Function

The E4991A has a function to analyze the statistical information of a specified trace, including averages, standard deviation, and the difference between maximum and minimum values. Use the following GPIB command to turn on/off the statistical analysis function.

- **CALC{1-5}:MST** on page 343

---

### NOTE

---

The statistical analysis function can only be used when the marker function is enabled. If a marker search range is specified, the statistical analysis is performed within that range.

Use the following GPIB command to read analysis results.

- **CALC{1-5}:MST:DATA?** on page 344

## Example Programs for Marker Search Function

Example programs for the marker search function are shown below. After a sweep is performed, the positive and negative peaks are searched within the range of 100 MHz - 1 GHz by the marker function, a marker is placed at each location, and the marked values are read and displayed.

### Example program using HTBasic

Example 7-1 shows an example program for the marker search function. This program is saved under the filename mkr\_sear.htb on the sample programs disk. Below is an explanation of the program's details.

Line 60	Sets the GPIB address.
Lines 80 - 150	Substitutes variables for the trace number, marker number, partial search range, and defined peak value.
Line 190	Resets the E4991A.
Lines 200 - 230	Displays Trace 1 and sets the measurement parameter. In addition, turns off Trace 2.
Line 250	Sets the sweep parameter (sweep type).
Lines 270 - 290	Sets the trigger source to the internal trigger and turns off the continuous activation of the trigger system. Then, it resets the trigger system and sets the trigger sequence to the idle state.
Line 310	Calls the sub-program for executing a sweep.
Line 330	Runs the auto-scale adjustment for Trace.
Lines 350 - 380	Turns on Markers 1 and 2 and sets the instrument to continuous marker mode.
Lines 400 - 450	Turns on the partial search function and sets the left and right boundaries of the partial search range.
Lines 470 -480	Sets the $\Delta X$ value and $\Delta Y$ value to define the peak.
Lines 520 - 540	After setting marker 1 as the active marker, searches for the positive peak and moves the marker to it.
Lines 550 - 630	Reads the marker search results by using a function sub-program (FNPeak_found). When a positive peak is found, reads the stimulus value and measurement value at the active marker (positive peak) position. Or, when a positive peak is not found, displays "Peak Not Found".
Lines 650 - 670	After setting marker 2 as the active marker, searches for the positive peak and moves the marker to it.
Lines 680 - 760	Reads the marker search results by using a function sub-program (FNPeak_found). When a negative peak is found, reads the stimulus value and measurement value at the active marker (negative peak) position. Or, when a negative peak is not found, displays "Peak Not Found".
Lines 800 - 1030	Refer to "Example Programs for Detecting Measurement End" on page 114 for an explanation of the sub-program.

Lines 1080 - 1120 In the function sub-program (FNPeak\_found), reads the marker search results at the specified trace by using questionable status marker condition resistor. When marker search failure occurs, a bit on the specified trace is set to 1 and the function sub-program returns the value of 1.

**Example 7-1 Searching for a peak by using a marker (HTBasic)**

```

10     INTEGER Trc1,Trc2,Mkr1,Mkr2
20     REAL Sear_start,Search_stop,Delta_x,Delta_y
30     REAL P_peak_x,P_peak_y,N_peak_x,N_peak_y
40     !
50     CLEAR SCREEN
60     ASSIGN @Agte4991a TO 717
70     !
80     Trc1=1
90     Trc2=2
100    Mkr1=1
110    Mkr2=2
120    Sear_start=1.00E+8
130    Sear_stop=1.E+9
140    Delta_x=1.0E+6
150    Delta_y=.1
160    !
170    ! E4991A settings
180    !
190    OUTPUT @Agte4991a;"SYST:PRES"
200    OUTPUT @Agte4991a;"DISP:TRAC"&VAL$(Trc1)&" ON"
210    OUTPUT @Agte4991a;"DISP:TRAC"&VAL$(Trc2)&" OFF"
220    OUTPUT @Agte4991a;"CALC"&VAL$(Trc1)&":FORM Z"
230    OUTPUT @Agte4991a;"DISP:TRAC"&VAL$(Trc1)&":SEL"
240    !
250    OUTPUT @Agte4991a;"SWE:TYPE LOG"
260    !
270    OUTPUT @Agte4991a;"TRIG:SOUR INT"
280    OUTPUT @Agte4991a;"INIT:CONT OFF"
290    OUTPUT @Agte4991a;"ABOR"
300    !
310    CALL Sweep(@Agte4991a)
320    !
330    OUTPUT @Agte4991a;"DISP:TRAC"&VAL$(Trc1)&":Y:AUTO"
340    !
350    OUTPUT @Agte4991a;"CALC"&VAL$(Trc1)&":MARK:AOFF"
360    OUTPUT @Agte4991a;"CALC"&VAL$(Trc1)&":MARK"&VAL$(Mkr1)&" ON"
370    OUTPUT @Agte4991a;"CALC"&VAL$(Trc1)&":MARK"&VAL$(Mkr2)&" ON"
380    OUTPUT @Agte4991a;"CALC"&VAL$(Trc1)&":MARK:DISC OFF"
390    !
400    OUTPUT @Agte4991a;"CALC"&VAL$(Trc1)&":MARK:FUNC:DOM ON"
410    OUTPUT
@Agte4991a;"CALC"&VAL$(Trc1)&":MARK"&VAL$(Mkr1)&":ACT"
420    OUTPUT @Agte4991a;"CALC"&VAL$(Trc1)&":MARK"&VAL$(Mkr1)&":X
"&VAL$(Sear_start)
430    OUTPUT @Agte4991a;"CALC"&VAL$(Trc1)&":MARK:FUNC:DOM:STAR"
440    OUTPUT @Agte4991a;"CALC"&VAL$(Trc1)&":MARK"&VAL$(Mkr1)&":X
"&VAL$(Sear_stop)
450    OUTPUT @Agte4991a;"CALC"&VAL$(Trc1)&":MARK:FUNC:DOM:STOP"
460    !
470    OUTPUT @Agte4991a;"CALC"&VAL$(Trc1)&":MARK:APE:EXC:X

```

## Measurement Result Processing Using Marker Function

```
"&VAL$(Delta_x)
480   OUTPUT @Agte4991a;"CALC"&VAL$(Trc1)&":MARK:APE:EXC:Y
"&VAL$(Delta_y)
490   !
500   PRINT "Search Range: "&VAL$(Sear_start/1.E+6)&"MHz -
"&VAL$(Sear_stop/1.E+6)&"MHz"
510   !
520   OUTPUT @Agte4991a;"CALC"&VAL$(Trc1)&":MARK"&VAL$(Mkr1)&":X
"&VAL$(Sear_start)
530   OUTPUT
@Agte4991a;"CALC"&VAL$(Trc1)&":MARK"&VAL$(Mkr1)&":ACT"
540   OUTPUT @Agte4991a;"CALC"&VAL$(Trc1)&":MARK:FUNC:EXEC PPE"
550   IF FNPeak_found(@Agte4991a,Trc1)=0 THEN
560     OUTPUT
@Agte4991a;"CALC"&VAL$(Trc1)&":MARK"&VAL$(Mkr1)&":X?"
570     ENTER @Agte4991a;P_peak_x
580     OUTPUT
@Agte4991a;"CALC"&VAL$(Trc1)&":MARK"&VAL$(Mkr1)&":Y?"
590     ENTER @Agte4991a;P_peak_y
600     PRINT "Positive Peak: ";P_peak_y;" [ohm]
@";P_peak_x/1.E+6;"MHz"
610   ELSE
620     PRINT "Positive Peak: Not Found"
630   END IF
640   !
650   OUTPUT @Agte4991a;"CALC"&VAL$(Trc1)&":MARK"&VAL$(Mkr2)&":X
"&VAL$(Sear_start)
660   OUTPUT
@Agte4991a;"CALC"&VAL$(Trc1)&":MARK"&VAL$(Mkr2)&":ACT"
670   OUTPUT @Agte4991a;"CALC"&VAL$(Trc1)&":MARK:FUNC:EXEC NPE"
680   IF FNPeak_found(@Agte4991a,Trc1)=0 THEN
690     OUTPUT
@Agte4991a;"CALC"&VAL$(Trc1)&":MARK"&VAL$(Mkr2)&":X?"
700     ENTER @Agte4991a;N_peak_x
710     OUTPUT
@Agte4991a;"CALC"&VAL$(Trc1)&":MARK"&VAL$(Mkr2)&":Y?"
720     ENTER @Agte4991a;N_peak_y
730     PRINT "Negative Peak: ";N_peak_y;" [ohm]
@";N_peak_x/1.E+6;"MHz"
740   ELSE
750     PRINT "Negative Peak: Not Found"
760   END IF
770   !
780   END
790   !
800   SUB Sweep(@Agte4991a)
810     DIM Buff$(9)
820     INTEGER Swp_bool
830     !
840     OUTPUT @Agte4991a;"CALC:AVER?"
850     ENTER @Agte4991a;Swp_bool
860     IF Swp_bool=1 THEN OUTPUT @Agte4991a;"CALC:AVER:CLE"
870     !
880     OUTPUT @Agte4991a;"STAT:OPER:PTR 0"
890     OUTPUT @Agte4991a;"STAT:OPER:NTR 16"
900     OUTPUT @Agte4991a;"STAT:OPER:ENAB 16"
910     OUTPUT @Agte4991a;"*SRE 128"
920     OUTPUT @Agte4991a;"*CLS"
```

```
930     OUTPUT @Agte4991a;"*OPC?"
940     ENTER @Agte4991a;Buff$
950     !
960     ON INTR 7 GOTO Swp_end
970     ENABLE INTR 7;2
980     OUTPUT @Agte4991a;"INIT"
990     DISP "Now Measuring..."
1000 Swp_wait: GOTO Swp_wait
1010 Swp_end: DISP "Sweep Complete"
1020     OFF INTR 7
1030     SUBEND
1040     !
1050     DEF FNPeak_found(@Agte4991a,INTEGER Trc)
1060         INTEGER Sear_cond,Peak_found
1070         !
1080         OUTPUT @Agte4991a;"STAT:QUES:SEAR:COND?"
1090         ENTER @Agte4991a;Sear_cond
1100         Peak_found=BIT(Sear_cond,Trc)
1110         RETURN Peak_found
1120     FNEND
```

## Measurement Result Processing Using Marker Function

### Example program using macro (E4991A VBA)

Example 7-2 shows an example program for the marker search function. This program is saved under the filename mkr\_sear.bas on the sample programs disk. Below is an explanation of the program's details.

Lines 110 - 180	Substitutes variables for the trace number, marker number, partial search range, and defined peak value.
Line 220	Resets the E4991A.
Lines 240 - 270	Displays Trace 1 and sets the measurement parameter. In addition, turns off Trace 2.
Line 290	Sets the sweep parameter (sweep type).
Lines 310 - 330	Sets the trigger source to the internal trigger and turns off the continuous activation of the trigger system. Then, it resets the trigger system and sets the trigger sequence to the idle state.
Lines 350 - 360	Resets sweep averaging when sweep averaging function is set to on.
Line 380	Starts the sweep and substitutes a variable of "bool" for sweep completion.
Lines 390 - 400	Displays a message of "Sweep Aborted" when sweep is aborted (bool=0) during the measurement.
Line 410	Describes the program routine below this line when sweep is completed without problem (bool=1).
Line 430	Executes an auto-scale adjustment on the specified trace.
Lines 450 - 480	Sets Marker 1 and Marker 2 to on and sets the instrument to continuous marker mode.
Lines 500 - 550	Turns on the partial search function and moves the active marker to a specified position on the X-axis. Next, sets the left and right boundaries of the partial search range.
Lines 570 - 580	Sets the $\Delta X$ and $\Delta Y$ values to define the peak.
Lines 620 - 640	Sets Marker 1 as the active marker. Next, executes a positive peak search and moves the active marker to the positive peak position.
Line 650	Reads out the result of the positive peak search using the function program "peak_not_found".
Lines 660 - 670	Displays a message of "Sweep Aborted" when a positive peak is not found.
Lines 680 - 740	Reads and displays the stimulus value and measurement value at the active marker (positive peak) position when a positive peak is found.
Lines 760 - 780	Sets Marker 2 as the active marker. Next, executes a negative peak search and moves the active marker to the negative peak position.
Line 790	Reads out the result of the negative peak search using the function program "peak_not_found".
Lines 800 - 810	Displays the message of "Sweep Aborted" when a negative peak is not found.
Lines 820 - 880	Reads and displays the stimulus value and measurement value at the

- active marker (negative peak) position when a negative peak is found.
- Line 910 Stops the execution of the macro.
- Lines 950 - 1510 In the function program (peak\_not\_found), reads the marker search results at the specified trace by using the questionable status marker condition resistor. When marker search failure occurs, the bit on the specified trace is set to 1 and the function program returns a value of 1.

**Example 7-2**

**Searching for a peak by using a marker (macro)**

```

10      Sub Main()
20      Dim trc1 As Integer, trc2 As Integer, mkr1 As Integer, mkr2
As Integer
30      Dim sear_start As Double, sear_stop As Double
40      Dim delta_x As Double, delta_y As Double
50      Dim p_peak_x As Double, p_peak_y As Double
60      Dim n_peak_x As Double, n_peak_y As Double
70      Dim peak_found As Integer
80      Dim swp_bool As Integer, beak_query As Integer, bool As
Integer
90      Dim msg As String
100
110     trc1 = 1
120     trc2 = 2
130     mkr1 = 1
140     mkr2 = 2
150     sear_start = 100000000#
160     sear_stop = 1000000000#
170     delta_x = 1000000#
180     delta_y = 0.1
190
200     ' E4991A settings
210
220     SCPI.Output "SYST:PRES"
230
240     SCPI.Output "DISP:TRAC" & CStr(trc1) & " ON"
250     SCPI.Output "DISP:TRAC" & CStr(trc2) & " OFF"
260     SCPI.Output "CALC" & CStr(trc1) & ":FORM Z"
270     SCPI.Output "DISP:TRAC" & CStr(trc1) & ":SEL"
280
290     SCPI.Output "SWE:TYPE LOG"
300
310     SCPI.Output "TRIG:SOUR INT"
320     SCPI.Output "INIT:CONT OFF"
330     SCPI.Output "ABOR"
340
350     swp_bool = SCPI.Query("CALC:AVER?")
360     If swp_bool = 1 Then SCPI.Output "CALC:AVER:CLE"
370
380     bool = SingleMeasure
390     If bool = 0 Then
400         MsgBox ("Sweep Aborted")
410     ElseIf bool = 1 Then
420
430         SCPI.Output "DISP:TRAC" & CStr(trc1) & ":Y:AUTO"
440
450         SCPI.Output "CALC" & CStr(trc1) & ":MARK:AOFF"
460         SCPI.Output "CALC" & CStr(trc1) & ":MARK" & CStr(mkr1) &

```

## Measurement Result Processing Using Marker Function

```
" ON"
470         SCPI.Output "CALC" & CStr(trc1) & ":MARK" & CStr(mkr2) &
" ON"
480         SCPI.Output "CALC" & CStr(trc1) & ":MARK:DISC OFF"
490
500         SCPI.Output "CALC" & CStr(trc1) & ":MARK:FUNC:DOM ON"
510         SCPI.Output "CALC" & CStr(trc1) & ":MARK" & CStr(mkr) &
":ACT"
520         SCPI.Output "CALC" & CStr(trc1) & ":MARK" & CStr(mkr) &
":X " & CStr(sear_start)
530         SCPI.Output "CALC" & CStr(trc1) & ":MARK:FUNC:DOM:STAR"
540         SCPI.Output "CALC" & CStr(trc1) & ":MARK" & CStr(mkr) &
":X " & CStr(sear_stop)
550         SCPI.Output "CALC" & CStr(trc1) & ":MARK:FUNC:DOM:STOP"
560
570         SCPI.Output "CALC" & CStr(trc1) & ":MARK:APE:EXC:X " &
CStr(delta_x)
580         SCPI.Output "CALC" & CStr(trc1) & ":MARK:APE:EXC:Y " &
CStr(delta_y)
590
600         msg = "Search range: " & CStr(sear_start / 1000000#) &
"MHz - " & CStr(sear_stop / 1000000#) & "MHz"
610
620         SCPI.Output "CALC" & CStr(trc1) & ":MARK" & CStr(mkr1) &
":X " & CStr(sear_start)
630         SCPI.Output "CALC" & CStr(trc1) & ":MARK" & CStr(mkr1) &
":ACT"
640         SCPI.Output "CALC" & CStr(trc1) & ":MARK:FUNC:EXEC PPE"
650         peak_query = peak_not_found(trc1)
660         If peak_query = 1 Then
670             MsgBox ("Positive Peak Not Found")
680         ElseIf peak_query = 0 Then
690             SCPI.Output "CALC" & CStr(trc1) & ":MARK" & CStr(mkr1)
& ":X?"
700             SCPI.Enter p_peak_x
710             SCPI.Output "CALC" & CStr(trc1) & ":MARK" & CStr(mkr1)
& ":Y?"
720             SCPI.Enter p_peak_y
730             MsgBox (msg & vbCrLf & "Positive Peak: " &
CStr(p_peak_y) & "[ohm] @" & CStr(p_peak_x / 1000000#) & "MHz")
740             End If
750
760         SCPI.Output "CALC" & CStr(trc1) & ":MARK" & CStr(mkr2) &
":X " & CStr(sear_start)
770         SCPI.Output "CALC" & CStr(trc1) & ":MARK" & CStr(mkr2) &
":ACT"
780         SCPI.Output "CALC" & CStr(trc1) & ":MARK:FUNC:EXEC NPE"
790         peak_query = peak_not_found(trc1)
800         If peak_query = 1 Then
810             MsgBox ("Negative Peak Not Found")
820         ElseIf peak_query = 0 Then
830             SCPI.Output "CALC" & CStr(trc1) & ":MARK" & CStr(mkr2)
& ":X?"
840             SCPI.Enter n_peak_x
850             SCPI.Output "CALC" & CStr(trc1) & ":MARK" & CStr(mkr2)
& ":Y?"
860             SCPI.Enter n_peak_y
870             MsgBox (msg & vbCrLf & "Negative Peak: " &
```



```
CStr(n_peak_y) & "[ohm] @" & CStr(n_peak_x / 1000000#) & "MHz")
880     End If
890     End If
900
910     End
920
930 End Sub
940
950 Private Function peak_not_found(trc As Integer)
960     Dim reg As String
970     Dim div As Integer, Mo As Integer
980
990     SCPI.Output "STAT:QUES:SEAR:COND?"
1000    SCPI.Enter reg
1010
1020    div = Val(reg) \ 32
1030    Mo = Val(reg) Mod 32
1040    If div = 1 Then
1050        trc5 = 1
1060    ElseIf div = 0 Then
1070        trc5 = 0
1080    End If
1090    div = Mo \ 16
1100    Mo = Mo Mod 16
1110    If div = 1 Then
1120        trc4 = 1
1130    ElseIf div = 0 Then
1140        trc4 = 0
1150    End If
1160    div = Mo \ 8
1170    Mo = Mo Mod 8
1180    If div = 1 Then
1190        trc3 = 1
1200    ElseIf div = 0 Then
1210        trc3 = 0
1220    End If
1230    div = Mo \ 4
1240    Mo = Mo Mod 4
1250    If div = 1 Then
1260        trc2 = 1
1270    ElseIf div = 0 Then
1280        trc2 = 0
1290    End If
1300    div = Mo \ 2
1310    Mo = Mo Mod 2
1320    If div = 1 Then
1330        trc1 = 1
1340    ElseIf div = 0 Then
1350        trc1 = 0
1360    End If
1370
1380    Select Case trc
1390    Case 1
1400        peak_not_found = trc1
1410    Case 2
1420        peak_not_found = trc2
1430    Case 3
1440        peak_not_found = trc3
```

## Measurement Result Processing Using Marker Function

```
1450      Case 4
1460          peak_not_found = trc4
1470      Case 5
1480          peak_not_found = trc5
1490      End Select
1500
1510      End Function
```

## Example Programs for Marker Limit Test Function

Below are example programs for the limit test function. After sweeping, this executes a limit test at the specified test marker position and displays the PASS/FAIL test results.

### Example program using HTBasic

Example 7-3 shows an example program for the marker limit test. This program is saved under the filename `lim_test.htb` on the sample programs disk. Below is an explanation of the program's details.

Line 70	Sets the GPIB address.
Lines 90 - 100	Substitutes a variable for the trace number.
Line 120 - 400	Substitutes variables for the stimulus value and the upper and lower values of the test limit used in the limit test.
Line 440	Resets the E4991A.
Lines 460 - 480	Turns on Trace 1 and sets the measurement parameter and display format. Turns off Trace 2.
Line 500	Sets the sweep parameter.
Lines 520 - 560	Sets the reference marker for the test marker and sets the stimulus value and the upper and lower limits for the test limit.
Line 580 - 640	Sets Markers 1-8 for the test marker and sets the stimulus value and the upper and lower limits for the test limit.
Line 660	Turns on the marker limit test function.
Lines 680 - 700	Sets the trigger source to the internal trigger and turns off the continuous activation of the trigger system. Then, it resets the trigger system and sets the trigger sequence to the idle state.
Line 730	Calls the sub-program for executing sweep.
Line 750	Executes auto-scale adjustment for the trace.
Lines 770 - 800	Reads the measured value of the reference marker and the result of the limit test.
Lines 820 - 870	Reads the measured values of the positions of Markers 1 - 8 and the limit test result.
Lines 890 - 900	Reads the overall decision results of the limit tests at all of the test markers.
Lines 920 - 1010	Displays the test conditions and results of the limit test.
Lines 1050 - 1280	Refer to "Example Programs for Detecting Measurement End" on page 114 for an explanation of the sub-program.

## Measurement Result Processing Using Marker Function

### Example 7-3

#### Execution of the limit test using a marker (HTBasic)

```
10 DIM Mkr1_stim(8),Mkr1_upp(8),Mkr1_low(8),Mkr1_meas(8)
20 DIM Ref_judge$(4),Mkr1_judge$(8)[4],All_judge$(4)
30 REAL Ref_stim,Ref_upp,Ref_low,Ref_meas
40 INTEGER Trc1,Trc2,Mkr
50 !
60 CLEAR SCREEN
70 ASSIGN @Agte4991a TO 717
80 !
90 Trc1=1
100 Trc2=2
110 !
120 Ref_stim=1.E+6
130 Mkr1_stim(1)=5.0E+6
140 Mkr1_stim(2)=1.0E+7
150 Mkr1_stim(3)=5.0E+7
160 Mkr1_stim(4)=1.0E+8
170 Mkr1_stim(5)=5.0E+8
180 Mkr1_stim(6)=1.0E+9
190 Mkr1_stim(7)=2.0E+9
200 Mkr1_stim(8)=3.0E+9
210 !
220 Ref_upp=80
230 Mkr1_upp(1)=80
240 Mkr1_upp(2)=70
250 Mkr1_upp(3)=70
260 Mkr1_upp(4)=70
270 Mkr1_upp(5)=70
280 Mkr1_upp(6)=80
290 Mkr1_upp(7)=80
300 Mkr1_upp(8)=90
310 !
320 Ref_low=20
330 Mkr1_low(1)=20
340 Mkr1_low(2)=30
350 Mkr1_low(3)=30
360 Mkr1_low(4)=30
370 Mkr1_low(5)=30
380 Mkr1_low(6)=20
390 Mkr1_low(7)=20
400 Mkr1_low(8)=10
410 !
420 ! E4991A settings
430 !
440 OUTPUT @Agte4991a;"SYST:PRES"
450 !
460 OUTPUT @Agte4991a;"DISP:TRAC"&VAL$(Trc1)&" ON"
470 OUTPUT @Agte4991a;"DISP:TRAC"&VAL$(Trc2)&" OFF"
480 OUTPUT @Agte4991a;"CALC"&VAL$(Trc1)&":FORM Z"
490 !
500 OUTPUT @Agte4991a;"SWE:TYPE LOG"
510 !
520 OUTPUT @Agte4991a;"CALC"&VAL$(Trc1)&":MARK:REF ON"
530 OUTPUT @Agte4991a;"CALC"&VAL$(Trc1)&":MARK:REF:FUNC:DOM:LIM
ON"
540 OUTPUT @Agte4991a;"CALC"&VAL$(Trc1)&":MARK:REF:X
```

```

"&VAL$(Ref_stim)
550   OUTPUT
@Agte4991a;"CALC"&VAL$(Trcl) &":MARK:REF:FUNC:DOM:LIM:UP
"&VAL$(Ref_upp)
560   OUTPUT
@Agte4991a;"CALC"&VAL$(Trcl) &":MARK:REF:FUNC:DOM:LIM:LOW
"&VAL$(Ref_low)
570   !
580   FOR Mkr=1 TO 8
590     OUTPUT @Agte4991a;"CALC"&VAL$(Trcl) &":MARK"&VAL$(Mkr) &" ON"
600     OUTPUT
@Agte4991a;"CALC"&VAL$(Trcl) &":MARK"&VAL$(Mkr) &":FUNC:DOM:LIM ON"
610     OUTPUT @Agte4991a;"CALC"&VAL$(Trcl) &":MARK"&VAL$(Mkr) &":X
"&VAL$(Mkr1_stim(Mkr))
620     OUTPUT
@Agte4991a;"CALC"&VAL$(Trcl) &":MARK"&VAL$(Mkr) &":FUNC:DOM:LIM:UP
"&VAL$(Mkr1_upp(Mkr))
630     OUTPUT
@Agte4991a;"CALC"&VAL$(Trcl) &":MARK"&VAL$(Mkr) &":FUNC:DOM:LIM:LOW
"&VAL$(Mkr1_low(Mkr))
640   NEXT Mkr
650   !
660   OUTPUT @Agte4991a;"CALC"&VAL$(Trcl) &":MARK:FUNC:DOM:LIM:ALL
ON"
670   !
680   OUTPUT @Agte4991a;"TRIG:SOUR INT"
690   OUTPUT @Agte4991a;"INIT:CONT OFF"
700   OUTPUT @Agte4991a;"ABOR"
710   !
720   !
730   CALL Sweep(@Agte4991a)
740   !
750   OUTPUT @Agte4991a;"DISP:TRAC"&VAL$(Trcl) &":Y:AUTO"
760   !
770   OUTPUT @Agte4991a;"CALC"&VAL$(Trcl) &":MARK:REF:Y?"
780   ENTER @Agte4991a;Ref_meas
790   OUTPUT
@Agte4991a;"CALC"&VAL$(Trcl) &":MARK:REF:FUNC:DOM:LIM:RES?"
800   ENTER @Agte4991a;Ref_judge$
810   !
820   FOR Mkr=1 TO 8
830     OUTPUT @Agte4991a;"CALC"&VAL$(Trcl) &":MARK"&VAL$(Mkr) &":Y?"
840     ENTER @Agte4991a;Mkr1_meas(Mkr)
850     OUTPUT
@Agte4991a;"CALC"&VAL$(Trcl) &":MARK"&VAL$(Mkr) &":FUNC:DOM:LIM:RES?"
860     ENTER @Agte4991a;Mkr1_judge$(Mkr)
870   NEXT Mkr
880   !
890   OUTPUT
@Agte4991a;"CALC"&VAL$(Trcl) &":MARK:FUNC:DOM:LIM:ALL:RES?"
900   ENTER @Agte4991a;All_judge$
910   !
920   PRINT "Marker Limit Test Results"
930   PRINT
940   PRINT "Mkr      freq.      lower      actual      upper
judge  "
950   PRINT
"-----

```

## Measurement Result Processing Using Marker Function

```
-"  
960     PRINT " R",Ref_stim,Ref_low,Ref_meas,Ref_upp,Ref_judge$  
970     FOR Mkr=1 TO 8  
980     PRINT  
Mkr,Mkr1_stim(Mkr),Mkr1_low(Mkr),Mkr1_meas(Mkr),Mkr1_upp(Mkr),Mkr1_  
judge$(Mkr)  
990     NEXT Mkr  
1000    PRINT  
"-----"  
1010    PRINT "total  
"&All_judge$  
1020    !  
1030    END  
1040    !  
1050    SUB Sweep(@Agte4991a)  
1060    DIM Buff$(9)  
1070    INTEGER Swp_bool  
1080    !  
1090    OUTPUT @Agte4991a;"CALC:AVER?"  
1100    ENTER @Agte4991a;Swp_bool  
1110    IF Swp_bool=1 THEN OUTPUT @Agte4991a;"CALC:AVER:CLE"  
1120    !  
1130    OUTPUT @Agte4991a;"STAT:OPER:PTR 0"  
1140    OUTPUT @Agte4991a;"STAT:OPER:NTR 16"  
1150    OUTPUT @Agte4991a;"STAT:OPER:ENAB 16"  
1160    OUTPUT @Agte4991a;"*SRE 128"  
1170    OUTPUT @Agte4991a;"*CLS"  
1180    OUTPUT @Agte4991a;"*OPC?"  
1190    ENTER @Agte4991a;Buff$  
1200    !  
1210    ON INTR 7 GOTO Swp_end  
1220    ENABLE INTR 7;2  
1230    OUTPUT @Agte4991a;"INIT"  
1240    DISP "Now Measuring..."  
1250 Swp_wait: GOTO Swp_wait  
1260 Swp_end: DISP "Sweep Complete"  
1270    OFF INTR 7  
1280    SUBEND
```

### Example program using macro (E4991A VBA)

Example 7-4 shows an example program for the marker limit test. This program is saved under the filename `lim_test.bas` on the sample programs disk. Below is an explanation of the program's details.

Lines 100 - 110	Substitutes a variable for the trace number.
Line 130 - 410	Substitutes variables for the stimulus value of the test marker and the upper and lower values of the test limit.
Line 450	Resets the E4991A.
Lines 470 - 490	Turns on Trace 1 and sets the measurement parameter and display format. Turns off Trace 2.
Line 510	Sets the sweep parameter.
Lines 530 - 570	Sets the reference marker to the test marker and sets the stimulus value for the test marker and the upper and lower values for the test limit.
Line 590 - 650	Sets Markers 1-8 to the test marker and sets the stimulus value for the test marker and the upper and lower values for the test limit.
Line 670	Turns on the marker limit test function.
Lines 690 - 710	Sets the trigger source to the internal trigger and turns off the continuous activation of the trigger system. Then, it resets the trigger system and sets the trigger sequence to the idle state.
Lines 730 - 740	Resets sweep averaging when sweep averaging function is set to on.
Line 760	Starts the sweep and substitutes a variable of "bool" for sweep completion.
Lines 770 - 780	Displays a message of "Sweep Aborted" when sweep is aborted (bool=0) during the measurement.
Line 790	Describes the program routine below this line when sweep is completed without problem (bool=1).
Line 800	Executes auto-scale adjustment for the specified trace.
Lines 820 - 850	Reads the measurement value at the reference marker and the results of the limit test.
Lines 870 - 920	Reads the measurement values at the Markers 1-8 and the results of the limit test.
Line 940	Reads the results of the limit tests at all of the test markers.
Lines 960 - 1110	Saves the limit test results to a specified file ( <code>a:\lim_res.txt</code> ) and displays the results of the limit test.
Line 1130	Stops the execution of the macro.

## Measurement Result Processing Using Marker Function

### Example 7-4

#### Execution of the limit test using a marker (macro)

```
10      Sub Main()
20          Dim mkr1_stim(8) As Double, mkr1_upp(8) As Double,
mkr1_low(8) As Double
30          Dim mkr1_meas(8) As Double
40          Dim ref_stim As Double, ref_upp As Double, ref_low As
Double, ref_meas As Double
50          Dim ref_judge As String, mkr1_judge(8) As String,
all_judge As String
60          Dim trc1 As Integer, trc2 As Integer, mkr As Integer
70          Dim swp_bool As Integer, bool As Integer
80          Dim file As String
90
100         trc1 = 1
110         trc2 = 2
120
130         ref_stim = 1000000#
140         mkr1_stim(1) = 5000000#
150         mkr1_stim(2) = 10000000#
160         mkr1_stim(3) = 50000000#
170         mkr1_stim(4) = 100000000#
180         mkr1_stim(5) = 500000000#
190         mkr1_stim(6) = 1000000000#
200         mkr1_stim(7) = 2000000000#
210         mkr1_stim(8) = 3000000000#
220
230         ref_upp = 80
240         mkr1_upp(1) = 80
250         mkr1_upp(2) = 70
260         mkr1_upp(3) = 70
270         mkr1_upp(4) = 70
280         mkr1_upp(5) = 70
290         mkr1_upp(6) = 80
300         mkr1_upp(7) = 80
310         mkr1_upp(8) = 80
320
330         ref_low = 20
340         mkr1_low(1) = 20
350         mkr1_low(2) = 30
360         mkr1_low(3) = 30
370         mkr1_low(4) = 30
380         mkr1_low(5) = 30
390         mkr1_low(6) = 20
400         mkr1_low(7) = 20
410         mkr1_low(8) = 20
420
430         ' E4991A settings
440
450         SCPI.Output "SYST:PRES"
460         '
470         SCPI.Output "DISP:TRAC" & CStr(trc1) & " ON"
480         SCPI.Output "DISP:TRAC" & CStr(trc2) & " OFF"
490         SCPI.Output "CALC" & CStr(trc1) & ":FORM Z"
500
510         SCPI.Output "SWE:TYPE LOG"
520
```



```

530     SCPI.Output "CALC" & CStr(trc1) & ":MARK:REF ON"
540     SCPI.Output "CALC" & CStr(trc1) & ":MARK:REF:FUNC:DOM:LIM
ON"
550     SCPI.Output "CALC" & CStr(trc1) & ":MARK:REF:X " &
CStr(ref_stim)
560     SCPI.Output "CALC" & CStr(trc1) &
":MARK:REF:FUNC:DOM:LIM:UP " & CStr(ref_upp)
570     SCPI.Output "CALC" & CStr(trc1) &
":MARK:REF:FUNC:DOM:LIM:LOW " & CStr(ref_low)
580
590     For mkr = 1 To 8
600         SCPI.Output "CALC" & CStr(trc1) & ":MARK" & CStr(mkr) &
" ON"
610         SCPI.Output "CALC" & CStr(trc1) & ":MARK" & CStr(mkr) &
":FUNC:DOM:LIM ON"
620         SCPI.Output "CALC" & CStr(trc1) & ":MARK" & CStr(mkr) &
":X " & CStr(mkr1_stim(mkr))
630         SCPI.Output "CALC" & CStr(trc1) & ":MARK" & CStr(mkr) &
":FUNC:DOM:LIM:UP " & CStr(mkr1_upp(mkr))
640         SCPI.Output "CALC" & CStr(trc1) & ":MARK" & CStr(mkr) &
":FUNC:DOM:LIM:LOW " & CStr(mkr1_low(mkr))
650     Next mkr
660
670     SCPI.Output "CALC" & CStr(trc1) & ":MARK:FUNC:DOM:LIM:ALL
ON"
680
690     SCPI.Output "TRIG:SOUR INT"
700     SCPI.Output "INIT:CONT OFF"
710     SCPI.Output "ABOR"
720
730     swp_bool = SCPI.Query("CALC:AVER?")
740     If swp_bool = 1 Then SCPI.Output "CALC:AVER:CLE"
750
760     bool = SingleMeasure
770     If bool = 0 Then
780         MsgBox ("Sweep Aborted")
790     ElseIf bool = 1 Then
800         SCPI.Output "DISP:TRAC" & CStr(trc1) & ":Y:AUTO"
810
820         SCPI.Output ("CALC" & CStr(trc1) & ":MARK:REF:Y?")
830         SCPI.Enter ref_meas
840         SCPI.Output ("CALC" & CStr(trc1) &
":MARK:REF:FUNC:DOM:LIM:RES?")
850         SCPI.Enter ref_judge
860
870         For mkr = 1 To 8
880             SCPI.Output ("CALC" & CStr(trc1) & ":MARK" & CStr(mkr)
& ":Y?")
890             SCPI.Enter mkr1_meas(mkr)
900             SCPI.Output ("CALC" & CStr(trc1) & ":MARK" & CStr(mkr)
& ":FUNC:DOM:LIM:RES?")
910             SCPI.Enter mkr1_judge(mkr)
920         Next mkr
930
940         all_judge = SCPI.Query("CALC" & CStr(trc1) &
":MARK:FUNC:DOM:LIM:ALL:RES?")
950
960         file = "a:\lim_res.txt"

```

## Measurement Result Processing Using Marker Function

```
970      Open file For Output As #1
980      Print #1, "Marker Limit Test Results"
990      Print #1, ""
1000     Print #1, " Mkr      freq.[MHz]      lower      actual
upper      judge"
1010     Print #1,
"-----"
-----"
1020     Print #1, "R", ref_stim / 1000000#, ref_low, ref_meas,
ref_upp, ref_judge
1030     For mkr = 1 To 8
1040         Print #1, mkr, mkr1_stim(mkr) / 1000000#,
mkr1_low(mkr), mkr1_meas(mkr), mkr1_upp(mkr), mkr1_judge(mkr)
1050     Next mkr
1060     Print #1,
"-----"
-----"
1070     Print #1, " total
" & all_judge
1080     Close #1
1090
1100     MsgBox ("Marker Limit Test: " & all_judge)
1110     End If
1120
1130     End
1140
1150     End Sub
```

## Equivalent Circuit Analysis

### Selecting an Equivalent Circuit Model

The E4991A allows you to select one of the following five types of circuit models to perform equivalent circuit analysis.

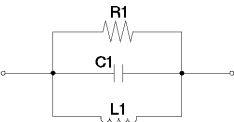
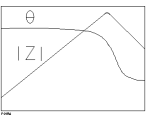
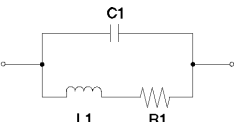
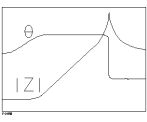
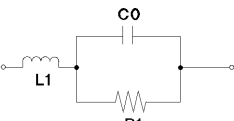
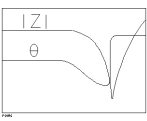
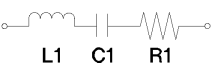
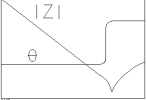
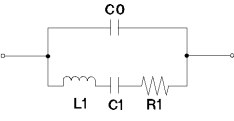
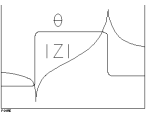
Equivalent circuit model type	DUT type	Typical frequency characteristics*1
A 	Inductor with high core loss	
B 	Inductor and resistor	
C 	Resistor with high resistance	
D 	Capacitor	
E 	Oscillator and resonator	

\*1. Measurement parameters:  $|Z|$  -  $\theta$ , Vertical axis format:  $|Z|$  indicates Log, and  $\theta$  indicates Linear.

Use the following GPIB command to select a circuit model type.

- **CALC{1-5}:EPAR:CIRC** on page 296

## Performing Equivalent Circuit Analysis

Use the following GPIB command to perform equivalent circuit analysis.

- **CALC{1-5}:EPAR** on page 295

---

**NOTE**

---

Equivalent circuit analysis is performed within the range specified for marker search.

Use the following GPIB command in the query format to read equivalent circuit analysis results (equivalent circuit parameters: R1, C1, L1, and C0).

- **CALC{1-5}:EPAR** on page 295

## Simulating Frequency Characteristics

The E4991A allows you to simulate frequency characteristics based on the values of the R1, C1, L1, and C0 parameters obtained from the equivalent circuit analysis and display the results as a memory trace on the screen. Use the following GPIB command to simulate frequency characteristics.

- **CALC{1-5}:EPAR:SIM** on page 297

The **CALC{1-5}:EPAR** command can be used to set the R1, C1, L1, and C1 parameters to any value. Therefore, you can use this command to set these parameters to desired values to simulate frequency characteristics and display the results on the screen.

## Example Programs for Equivalent Circuit Analysis

Below are example programs of equivalent circuit analysis. After a sweep, the equivalent circuit model is set to E, the equivalent circuit analysis is performed, and the results are read and displayed. In addition, frequency characteristics are simulated using the parameters of the analysis results.

### Example program using HTBasic

Example 7-5 shows an example program for the equivalent circuit analysis. This program is saved under the filename circuit.htb on the sample programs disk. Below is an explanation of the program's details.

Line 60	Sets the GPIB address.
Lines 80 - 140	Substitute variables for the sweep range, number of measurement points, trace number, sweep averaging factor, and type of equivalent circuit model.
Line 180	Resets the E4991A.
Lines 200 - 240	Turns on Trace 1 and Trace 2. In addition, sets the measurement parameters for each trace.
Lines 260 - 310	Sets the sweep conditions and sweep averaging function.
Lines 330 - 350	Sets the trigger source to the internal trigger and turns off the continuous activation of the trigger system. Then, it resets the trigger system and sets the trigger sequence to the idle state.
Line 370	Calls the sub-program for executing sweep.
Lines 390 - 400	Executes auto-scale adjustment for the trace.
Lines 420 - 430	Sets the equivalent circuit model and executes the equivalent circuit analysis.
Lines 450 - 580	Reads and displays the values of the equivalent circuit parameter.
Lines 600 - 650	Simulates the frequency characteristics of the equivalent circuit. After that, auto-scale adjustment is executed for both data trace and memory trace.
Lines 690 - 710	Reads the simulation results of the frequency characteristics in the memory trace.
Lines 730 - 780	Saves in the external computer the simulation results of the frequency characteristics that were read.
Lines 820 - 1050	Refer to "Example Programs for Detecting Measurement End" on page 114 for an explanation of the sub-program.

### Example 7-5

#### Equivalent circuit analysis (HTBasic)

```

10  INTEGER Trc1,Trc2,Nop,Swp_count,Data_size
20  DIM Equ_model$(1),Start_f$(9),Stop_f$(9),File$(20)
30  REAL R1,C1,L1,C0,Sim_data_z(1:201),Sim_data_thd(1:201)
40  !
50  CLEAR SCREEN
60  ASSIGN @Agte4991a TO 717
70  !
80  Start_f$="50MHZ"

```

## Measurement Result Processing Equivalent Circuit Analysis

```
90      Stop_f$="150MHZ"
100     Nop=201
110     Trc1=1
120     Trc2=2
130     Swp_count=1
140     Equ_model$="E"
150     !
160     ! E4991A settings
170     !
180     OUTPUT @Agte4991a;"SYST:PRES"
190     !
200     OUTPUT @Agte4991a;"DISP:TRAC"&VAL$(Trc1)&" ON"
210     OUTPUT @Agte4991a;"CALC"&VAL$(Trc1)&":FORM Z"
220     OUTPUT @Agte4991a;"DISP:TRAC"&VAL$(Trc2)&" ON"
230     OUTPUT @Agte4991a;"CALC"&VAL$(Trc2)&":FORM ZPH"
240     OUTPUT @Agte4991a;"CALC"&VAL$(Trc2)&":FORM:UNIT:ANGL DEG"
250     !
260     OUTPUT @Agte4991a;"SWE:TYPE LIN"
270     OUTPUT @Agte4991a;"FREQ:STAR "&Start_f$
280     OUTPUT @Agte4991a;"FREQ:STOP "&Stop_f$
290     OUTPUT @Agte4991a;"SWE:POIN "&VAL$(Nop)
300     OUTPUT @Agte4991a;"CALC:AVER:COUN "&VAL$(Swp_count)
310     OUTPUT @Agte4991a;"CALC:AVER ON"
320     !
330     OUTPUT @Agte4991a;"TRIG:SOUR INT"
340     OUTPUT @Agte4991a;"INIT:CONT OFF"
350     OUTPUT @Agte4991a;"ABOR"
360     !
370     CALL Sweep(@Agte4991a)
380     !
390     OUTPUT @Agte4991a;"DISP:TRAC"&VAL$(Trc1)&":Y:AUTO"
400     OUTPUT @Agte4991a;"DISP:TRAC"&VAL$(Trc2)&":Y:AUTO"
410     !
420     OUTPUT @Agte4991a;"CALC"&VAL$(Trc1)&":EPAR:CIRC "&Equ_model$
430     OUTPUT @Agte4991a;"CALC"&VAL$(Trc1)&":EPAR"
440     !
450     OUTPUT @Agte4991a;"CALC"&VAL$(Trc1)&":DATA:EPAR? EQR1"
460     ENTER @Agte4991a;R1
470     OUTPUT @Agte4991a;"CALC"&VAL$(Trc1)&":DATA:EPAR? EQC1"
480     ENTER @Agte4991a;C1
490     OUTPUT @Agte4991a;"CALC"&VAL$(Trc1)&":DATA:EPAR? EQL1"
500     ENTER @Agte4991a;L1
510     OUTPUT @Agte4991a;"CALC"&VAL$(Trc1)&":DATA:EPAR? EQC0"
520     ENTER @Agte4991a;C0
530     !
540     PRINT " --- Result ---"
550     PRINT "R1 :";R1;" [ohm]"
560     PRINT "C1 :";C1;" [F]"
570     PRINT "L1 :";L1;" [H]"
580     PRINT "C0 :";C0;" [F]"
590     !
600     OUTPUT @Agte4991a;"CALC"&VAL$(Trc1)&":EPAR:SIM"
610     OUTPUT @Agte4991a;"CALC"&VAL$(Trc2)&":EPAR:SIM"
620     OUTPUT @Agte4991a;"DISP:TRAC"&VAL$(Trc1)&":Y:FOR AND"
630     OUTPUT @Agte4991a;"DISP:TRAC"&VAL$(Trc2)&":Y:FOR AND"
640     OUTPUT @Agte4991a;"DISP:TRAC"&VAL$(Trc1)&":Y:AUTO"
650     OUTPUT @Agte4991a;"DISP:TRAC"&VAL$(Trc2)&":Y:AUTO"
660     !
```

```
670 OUTPUT @Agte4991a;"FORM:DATA ASC"
680 OUTPUT @Agte4991a;"CALC"&VAL$(Trc1)&":DATA? FMEM"
690 ENTER @Agte4991a;Sim_data_z(*)
700 OUTPUT @Agte4991a;"CALC"&VAL$(Trc2)&":DATA? FMEM"
710 ENTER @Agte4991a;Sim_data_thd(*)
720 !
730 File$="equ_trace"
740 Data_size=(Nop*2)*8
750 CREATE File$,Data_size
760 ASSIGN @File TO File$;FORMAT OFF
770 OUTPUT @File;Sim_data_z(*),Sim_data_thd(*)
780 ASSIGN @File TO *
790 !
800 END
810 !
820 SUB Sweep(@Agte4991a)
830 DIM Buff$[9]
840 INTEGER Swp_bool
850 !
860 OUTPUT @Agte4991a;"CALC:AVER?"
870 ENTER @Agte4991a;Swp_bool
880 IF Swp_bool=1 THEN OUTPUT @Agte4991a;"CALC:AVER:CLE"
890 !
900 OUTPUT @Agte4991a;"STAT:OPER:PTR 0"
910 OUTPUT @Agte4991a;"STAT:OPER:NTR 16"
920 OUTPUT @Agte4991a;"STAT:OPER:ENAB 16"
930 OUTPUT @Agte4991a;"*SRE 128"
940 OUTPUT @Agte4991a;"*CLS"
950 OUTPUT @Agte4991a;"*OPC?"
960 ENTER @Agte4991a;Buff$
970 !
980 ON INTR 7 GOTO Swp_end
990 ENABLE INTR 7;2
1000 OUTPUT @Agte4991a;"INIT"
1010 DISP "Now Measuring..."
1020 Swp_wait: GOTO Swp_wait
1030 Swp_end: DISP "Sweep Complete"
1040 OFF INTR 7
1050 SUBEND
```

## Measurement Result Processing

### Equivalent Circuit Analysis

#### Example program using macro (E4991A VBA)

Example 7-6 shows an example program for the equivalent circuit analysis. This program is saved under the filename circuit.bas on the sample programs disk. Below is an explanation of the details of the program.

Lines 120 - 180	Substitutes variables for the sweep range, number of measurement points, trace number, sweep averaging factor, and type of the equivalent circuit model.
Line 220	Resets the E4991A.
Lines 240 - 280	Turns on Trace 1 and Trace 2. In addition, sets the measurement parameters for each trace.
Lines 300 - 350	Sets the sweep conditions and sweep averaging function.
Lines 370 - 390	Sets the trigger source to the internal trigger and turns off the continuous activation of the trigger system. Then, it resets the trigger system and sets the trigger sequence to the idle state.
Lines 410 - 420	Resets sweep averaging when sweep averaging function is set to on.
Line 440	Starts the sweep and substitutes a variable of “bool” for sweep completion.
Lines 450 - 460	Displays a message of “Sweep Aborted” when sweep is aborted (bool=0) during the measurement.
Line 470	Describes the program routine below this line when sweep is completed without problem (bool=1).
Lines 480 - 490	Executes auto-scale adjustment for the specified trace.
Lines 510 - 520	Sets the equivalent circuit model and executes the equivalent circuit analysis.
Lines 540 - 600	Reads and displays the values of the equivalent circuit parameter.
Lines 620 - 670	Simulates the frequency characteristics of the equivalent circuit. After that, auto-scale adjustment is executed for both data trace and memory trace.
Lines 690 - 730	Reads the simulation results of the frequency characteristics in the memory trace.
Lines 750 - 840	Saves the simulation results of the frequency characteristics to a specified file (a:\equ_trace).
Lines 820 - 1050	Stops the execution of the macro.

#### Example 7-6

#### Equivalent circuit analysis (macro)

```
10      Sub Main()  
20          Dim trc1 As Integer, trc2 As Integer, nop As Integer  
30          Dim swp_count As Integer, data_size As Integer  
40          Dim equ_model As String, start_f As String, stop_f As  
String  
50          Dim file As String, buff As String  
60          Dim r1 As Double, c1 As Double, l1 As Double, c0 As Double  
70          Dim sim_data_z As Variant, sim_data_thd As Variant  
80          Dim i As Integer, swp_bool As Integer, bool As Integer  
90          Dim fileNum As Integer
```



```

100 Dim msg As String
110
120 start_f = "50MHZ"
130 stop_f = "150MHZ"
140 nop = 201
150 trc1 = 1
160 trc2 = 2
170 swp_count = 1
180 equ_model = "E"
190
200 ' E4991A settings
210
220 SCPI.Output "SYST:PRES"
230 '
240 SCPI.Output "DISP:TRAC" & CStr(trc1) & " ON"
250 SCPI.Output "CALC" & CStr(trc1) & ":FORM Z"
260 SCPI.Output "DISP:TRAC" & CStr(trc2) & " ON"
270 SCPI.Output "CALC" & CStr(trc2) & ":FORM ZPH"
280 SCPI.Output "CALC" & CStr(trc2) & ":FORM:UNIT:ANGL DEG"
290
300 SCPI.Output "SWE:TYPE LIN"
310 SCPI.Output "FREQ:STAR " & start_f
320 SCPI.Output "FREQ:STOP " & stop_f
330 SCPI.Output "SWE:POIN " & CStr(nop)
340 SCPI.Output "CALC:AVER:COUN " & CStr(swp_count)
350 SCPI.Output "CALC:AVER ON"
360
370 SCPI.Output "TRIG:SOUR INT"
380 SCPI.Output "INIT:CONT OFF"
390 SCPI.Output "ABOR"
400
410 swp_bool = SCPI.Query("CALC:AVER?")
420 If swp_bool = 1 Then SCPI.Output "CALC:AVER:CLE"
430
440 bool = SingleMeasure
450 If bool = 0 Then
460     MsgBox ("Sweep Aborted")
470 ElseIf bool = 1 Then
480     SCPI.Output "DISP:TRAC" & CStr(trc1) & ":Y:AUTO"
490     SCPI.Output "DISP:TRAC" & CStr(trc2) & ":Y:AUTO"
500
510     SCPI.Output "CALC" & CStr(trc1) & ":EPAR:CIRC " &
equ_model
520     SCPI.Output "CALC" & CStr(trc1) & ":EPAR"
530
540     r1 = SCPI.Query("CALC" & CStr(trc1) & ":DATA:EPAR?
EQR1")
550     c1 = SCPI.Query("CALC" & CStr(trc1) & ":DATA:EPAR?
EQC1")
560     l1 = SCPI.Query("CALC" & CStr(trc1) & ":DATA:EPAR?
EQL1")
570     c0 = SCPI.Query("CALC" & CStr(trc1) & ":DATA:EPAR?
EQC0")
580
590     msg = "Equivalent Circuit Parameters" & vbCrLf & vbCrLf
& "R1=" & CStr(r1) & vbCrLf & "C1=" & CStr(c1) & vbCrLf & "L1=" &
CStr(l1) & vbCrLf & "C0=" & CStr(c0)
600     MsgBox (msg)

```

## Measurement Result Processing

### Equivalent Circuit Analysis

```
610
620     SCPI.Output "CALC" & CStr(trc1) & ":EPAR:SIM"
630     SCPI.Output "CALC" & CStr(trc2) & ":EPAR:SIM"
640     SCPI.Output "DISP:TRAC" & CStr(trc1) & ":Y:FOR AND"
650     SCPI.Output "DISP:TRAC" & CStr(trc2) & ":Y:FOR AND"
660     SCPI.Output "DISP:TRAC" & CStr(trc1) & ":Y:AUTO"
670     SCPI.Output "DISP:TRAC" & CStr(trc2) & ":Y:AUTO"
680
690     SCPI.Output "FORM:DATA ASC"
700     SCPI.Output "CALC" & CStr(trc1) & ":DATA? FMEM"
710     SCPI.Enter sim_data_z, "#"
720     SCPI.Output "CALC" & CStr(trc2) & ":DATA? FMEM"
730     SCPI.Enter sim_data_thd, "#"
740
750     file = "a:\equ_trace"
760     fileNum = FreeFile
770     Open file For Output As #fileNum
780     For i = 1 To nop
790         Print #fileNum, Val(sim_data_z(i - 1))
800     Next i
810     For i = 1 To nop
820         Print #fileNum, Val(sim_data_thd(i - 1))
830     Next i
840     Close #fileNum
850 End If
860
870 End
880 End Sub
```

---

## **8** Save and Recall Files

This chapter explains how to save the Agilent E4991A's measurement condition settings or measurement results to a file and how to later recall them from the file.

## **Saving and Recalling Files**

### **Current Folder**

Basically, file save and recall operations are performed on the specified files in the current folder.

### **Specifying Current Folder**

Use the following GPIB command to change the current folder. In the factory default settings, the current folder is set to “D:\Documents.”

- **MMEM:CDIR** on page 383

### **Recalling File List**

The following GPIB command can be used to recall a list of files in the current folder.

- **MMEM:CAT?** on page 383

## Saving Files

The E4991A allows saving the following measurement condition settings and measurement results to a file.

### Saved Files

The E4991A provides several GPIB commands corresponding to the types of files to be saved, as shown in the table below.

File type	What is saved	GPIB command
State file (with extension .sta)	Information such as measurement conditions *1 is saved.	<b>MMEM:STOR</b> on page 388
Data file (with extension .dat)	The specified internal data array is saved in binary format.	<b>MMEM:STOR:TRAC</b> on page 391
Data file (with extension .txt)	The specified internal data array is saved in ASCII format.	<b>MMEM:STOR:TRAC:ASC</b> on page 391
Graphics file (with extension .jpg)	Graphical image is saved in the JPEG format.	<b>MMEM:STOR:GRAP</b> on page 389
Graphics file (with extension .bmp)	Graphical image is saved in MS Window's bitmap format.	<b>MMEM:STOR:GRAP:BMP</b> on page 390
CITIfile (with extension .txt)	The CITIfile of the selected model is saved.	<b>MMEM:STOR:CITI{1-3}</b> on page 389
Macro file (with extension .lcr)	A macro is saved.	<b>MMEM:STOR:MACR</b> on page 390

\*1. This information includes measurement conditions, calibration data array/calibration coefficient array, fixture compensation data array/fixture compensation coefficient array, data array/data trace array, memory array/memory trace array, standard values of a user-defined calibration kit, and standard values of a user-defined fixture compensation kit.

### Selecting Internal Data Array

When saving the E4991A's internal data array, use the following GPIB command to select the internal data array to be saved.

- **MMEM:STOR:TRAC:SEL{1-4}** on page 392

## Recalling Files

The following GPIB commands can be used to recall measurement condition settings and measurement results.

File type	What is recalled	GPIB command
State file (with extension .sta)	Recalls what was saved with the <b>MMEM:STOR</b> command.	<b>MMEM:LOAD</b> on page 385
Data file in binary format (with extension .dat)	Recalls an internal data array saved in binary format with the <b>MMEM:STOR:TRAC</b> command.	<b>MMEM:LOAD:TRAC</b> on page 386
Macro program (with extension .lcr)	Loads a macro that was saved with the <b>MMEM:STOR:MACR</b> command.	<b>MMEM:LOAD:MACR</b> on page 385

## Automatic Recall of State File

If the “D:\” folder contains the state file named “Autorec.sta,” the next time the E4991A starts, the state file is recalled automatically to set up the E4991A in the state defined in this file.

---

## Folder and File Manipulation

The E4991A allows the following operations to manipulate folders and files.

### Folders

#### Create

Use the following GPIB command to create a new folder.

- **MMEM:MDIR** on page 386

#### Delete

Use the following GPIB command to delete a folder.

- **MMEM:RDIR** on page 388

### Files

#### Rename

Use the following GPIB command to rename an existing file. The original and renamed file names must be specified with an extension.

- **MMEM:MOVE** on page 387

#### Copy

Use the following GPIB command to duplicate a file. The source and destination file names must be specified with an extension.

- **MMEM:COPY** on page 384

#### Delete

Use the following GPIB command to delete a specified file. The file to be deleted must be specified with an extension.

- **MMEM:DEL** on page 384

---

## Example Programs for Saving/Recalling a File

Example programs for saving/recalling a file are shown below. A file is saved/recalled by choosing the appropriate sub-program from a menu.

### Example program using HTBasic

Example 8-1 shows an example program for saving/recalling a file using HTBasic. This program is saved under the filename `save_rec.htb` on the sample programs disk. Below is an explanation of the program's details.

Line 50	Sets the GPIB address.
Lines 70 - 390	User calls the sub-program from the menu to save/recall the specified file and changes the current folder for saving/recalling the file.
Lines 450 - 710	Indicates the current folder and makes changes in it in the sub-program <code>Chn_curr_holder</code> . Asks to input the file name again if the folder name is inappropriate.
Lines 730 - 990	Saves the state file under any filename in the sub-program <code>Save_state</code> . Asks to input the file name again if an error occurs while saving the file.
Lines 1010 - 1270	Recalls any state file in the sub-program <code>Recall_state</code> . Asks to input the filename again if an error occurs while recalling the file.
Lines 1290 - 1830	Saves the data file under any filename in the sub-program <code>Save_data</code> . Before saving, selects the kind of internal data array to be saved in the file and the file type (ASCII or binary). Asks to input the filename again if an error occurs while saving the file.
Lines 1850 - 2110	Recalls any data file (in binary format) in the sub-program <code>Recall_data</code> . Asks to input the file name again if an error occurs while recalling the file.
Lines 2130 - 2470	Saves the CITIfile under any filename in the sub-program <code>Save_citi</code> . Selects a model type for the CITIfile before saving. Asks to input the filename again if an error occurs while saving the file.
Lines 2490 - 2830	Saves a graphics file under any filename in the sub-program <code>Save_graphics</code> . Selects saving the measurement display in either bitmap format or JPEG format. Asks to input the file name again if an error occurs while saving the file.



**Example 8-1      Saving/Recalling (HTBasic)**

```

10     DIM File$[256],Inp_chr$[30],Err_mes$[50],Extension$[3]
20     INTEGER Err_no
30     !
40     CLEAR SCREEN
50     ASSIGN @Agte4991a TO 717
60     !
70 Menu: BEEP
80     PRINT "           Save/Recall Menu"
90     PRINT "-----"
100    PRINT " 1: return and changes current holder"
110    PRINT " 2: saves state file"
120    PRINT " 3: recall state file"
130    PRINT " 4: saves data file"
140    PRINT " 5: recall data file"
150    PRINT " 6: saves CITIfile"
160    PRINT " 7: saves graphics data"
170    PRINT " 8: quit"
180    PRINT
190    INPUT "Input 1 to 8",Inp_chr$
200    !
210    SELECT Inp_chr$[1,2]
220    CASE "1"
230        CALL Chn_curr_holder(@Agte4991a)
240    CASE "2"
250        CALL Save_state(@Agte4991a)
260    CASE "3"
270        CALL Recall_state(@Agte4991a)
280    CASE "4"
290        CALL Save_data(@Agte4991a)
300    CASE "5"
310        CALL Recall_data(@Agte4991a)
320    CASE "6"
330        CALL Save_citi(@Agte4991a)
340    CASE "7"
350        CALL Save_graphics(@Agte4991a)
360    CASE "8"
370        GOTO Quit
380    END SELECT
390    GOTO Menu
400    !
410 Quit: !
420    END
430    !
440    !
450    SUB Chn_curr_holder(@Agte4991a)
460        DIM Holder$[256],Inp_chr$[30],Err_mes$[50]
470        INTEGER Err_no
480        !
490        OUTPUT @Agte4991a;"MMEM:CDIR?"
500        ENTER @Agte4991a;Holder$
510        PRINT "current holder name: "&Holder$
520        PRINT
530    Input_name: !
540        INPUT "Do you want to change current holder?
[Y/N]",Inp_chr$

```

## Save and Recall Files

### Example Programs for Saving/Recalling a File

```
550     IF UPC$(Inp_chr$)="Y" THEN
560         INPUT "Input new current folder name you wish",Holder$
570         Holder$=" "&Holder$&" "
580         OUTPUT @Agte4991a;"MMEM:CDIR "&Holder$
590         OUTPUT @Agte4991a;"SYST:ERR?"
600         ENTER @Agte4991a;Err_no,Err_mes$
610         IF Err_no<>0 THEN
620             BEEP
630             PRINT Err_mes$&" occurred"
640             PRINT
650             GOTO Input_name
660         ELSE
670             PRINT "new current holder name: "&Holder$
680             PRINT
690         END IF
700     END IF
710 SUBEND
720 !
730 SUB Save_state(@Agte4991a)
740     DIM File$[256],Inp_chr$[30],Err_mes$[50]
750     INTEGER Err_no
760     !
770 Input_name:!
780     INPUT "Input state file name without extension you wish to
save.",File$
790     File$=" "&File$&" "
800     PRINT "file name : "&File$
810     PRINT
820     INPUT "Do you want to change file name again?
[Y/N]",Inp_chr$
830     IF UPC$(Inp_chr$)="N" THEN
840         OUTPUT @Agte4991a;"MMEM:STOR "&File$
850         OUTPUT @Agte4991a;"SYST:ERR?"
860         ENTER @Agte4991a;Err_no,Err_mes$
870         IF Err_no<>0 THEN
880             BEEP
890             PRINT Err_mes$&" occurred"
900             PRINT
910             GOTO Input_name
920         ELSE
930             PRINT "save done"
940             PRINT
950         END IF
960     ELSE
970         GOTO Input_name
980     END IF
990 SUBEND
1000 !
1010 SUB Recall_state(@Agte4991a)
1020     DIM File$[256],Inp_chr$[30],Err_mes$[50]
1030     INTEGER Err_no
1040     !
1050 Input_name:!
1060     INPUT "Input state file name without extension you wish to
recall.",File$
1070     File$=" "&File$&" "
1080     PRINT "file name : "&File$
1090     PRINT
```

```

1100     INPUT "Do you want to change file name again?
[Y/N]",Inp_chr$
1110     IF UPC$(Inp_chr$)="N" THEN
1120         OUTPUT @Agte4991a;"MMEM:LOAD "&File$
1130         OUTPUT @Agte4991a;"SYST:ERR?"
1140         ENTER @Agte4991a;Err_no,Err_mes$
1150         IF Err_no<>0 THEN
1160             BEEP
1170             PRINT Err_mes$&" ocured"
1180             PRINT
1190             GOTO Input_name
1200         ELSE
1210             PRINT "recall done"
1220             PRINT
1230         END IF
1240     ELSE
1250         GOTO Input_name
1260     END IF
1270 SUBEND
1280     !
1290 SUB Save_data(@Agte4991a)
1300     DIM
File$[256],Inp_chr$[30],File_type$[30],Err_mes$[50],Bool$[3]
1310     INTEGER I,Err_no
1320     !
1330     PRINT "Select the Save Data Array"
1340     PRINT
1350     FOR I=1 TO 4
1360         SELECT I
1370         CASE 1
1380             INPUT "Do you want to save data array? [Y/N]",Inp_chr$
1390         CASE 2
1400             INPUT "Do you want to save data trace array?
[Y/N]",Inp_chr$
1410         CASE 3
1420             INPUT "Do you want to save memory array? [Y/N]",Inp_chr$
1430         CASE 4
1440             INPUT "Do you want to save memory trace array?
[Y/N]",Inp_chr$
1450         END SELECT
1460         IF UPC$(Inp_chr$)="Y" THEN
1470             OUTPUT @Agte4991a;"MMEM:STOR:TRAC:SEL"&VAL$(I)&" ON"
1480         ELSE
1490             OUTPUT @Agte4991a;"MMEM:STOR:TRAC:SEL"&VAL$(I)&" OFF"
1500         END IF
1510     NEXT I
1520     !
1530     PRINT "Select the File Type, ASCII or Binary"
1540     PRINT
1550     INPUT "Input the first letter of a word [A/B]",File_type$
1560     !
1570 Input_name:!
1580     INPUT "Input data file name without extension you wish to
save.",File$
1590     File$="""&File$&""
1600     PRINT "file name : "&File$
1610     PRINT
1620     INPUT "Do you want to change file name again?

```

## Save and Recall Files

### Example Programs for Saving/Recalling a File

```
[Y/N]",Inp_chr$
1630     IF UPC$(Inp_chr$)="N" THEN
1640         IF UPC$(File_type$[1,1])="A" THEN
1650             OUTPUT @Agte4991a;"MMEM:STOR:TRAC:ASCII "&File$
1660         ELSE
1670             OUTPUT @Agte4991a;"MMEM:STOR:TRAC "&File$
1680         END IF
1690         OUTPUT @Agte4991a;"SYST:ERR?"
1700         ENTER @Agte4991a;Err_no,Err_mes$
1710         IF Err_no<>0 THEN
1720             BEEP
1730             PRINT Err_mes$&" occured"
1740             PRINT
1750             GOTO Input_name
1760         ELSE
1770             PRINT "save done"
1780             PRINT
1790         END IF
1800     ELSE
1810         GOTO Input_name
1820     END IF
1830 SUBEND
1840 !
1850 SUB Recall_data(@Agte4991a)
1860     DIM File$[256],Inp_chr$[30],Err_mes$[50]
1870     INTEGER Err_no
1880     !
1890 Input_name:!
1900     INPUT "Input binary data file name without extension you
wish to recall.",File$
1910     File$="""&File$&""
1920     PRINT "file name : "&File$
1930     PRINT
1940     INPUT "Do you want to change file name again?
[Y/N]",Inp_chr$
1950     IF UPC$(Inp_chr$)="N" THEN
1960         OUTPUT @Agte4991a;"MMEM:LOAD:TRAC "&File$
1970         OUTPUT @Agte4991a;"SYST:ERR?"
1980         ENTER @Agte4991a;Err_no,Err_mes$
1990         IF Err_no<>0 THEN
2000             BEEP
2010             PRINT Err_mes$&" occured"
2020             PRINT
2030             GOTO Input_name
2040         ELSE
2050             PRINT "recall done"
2060             PRINT
2070         END IF
2080     ELSE
2090         GOTO Input_name
2100     END IF
2110 SUBEND
2120 !
2130 SUB Save_citi(@Agte4991a)
2140     DIM File$[256],Inp_chr$[30],File_type$[30],Err_mes$[50]
2150     INTEGER Model,Err_no
2160     !
2170     PRINT "Select the model of the CITIfile as follows;"
```

```

2180     PRINT
2190     PRINT "1: 1 Port"
2200     PRINT "2: 2 Port Series"
2210     PRINT "3: 2 Port Shunt"
2220     PRINT
2230     INPUT "Select the CITIfile model type [1-3]",Model
2240     !
2250 Input_name:!
2260     INPUT "Input CITIfile name without extension you wish to
save.",File$
2270     File$=" "&File$&" "
2280     PRINT "file name : "&File$
2290     PRINT
2300     INPUT "Do you want to change file name again?
[Y/N]",Inp_chr$
2310     IF UPC$(Inp_chr$)="N" THEN
2320         OUTPUT @Agte4991a;"MMEM:STOR:CITI"&VAL$(Model)&" "&File$
2330         OUTPUT @Agte4991a;"SYST:ERR?"
2340         ENTER @Agte4991a;Err_no,Err_mes$
2350         IF Err_no<>0 THEN
2360             BEEP
2370             PRINT Err_mes$&" occurred"
2380             PRINT
2390             GOTO Input_name
2400         ELSE
2410             PRINT "save done"
2420             PRINT
2430             END IF
2440     ELSE
2450         GOTO Input_name
2460     END IF
2470 SUBEND
2480 !
2490 SUB Save_graphics(@Agte4991a)
2500     DIM File$[256],Inp_chr$[30],File_type$[30],Err_mes$[50]
2510     INTEGER Err_no
2520     !
2530     PRINT "Select the File Type, BMP or JPEG"
2540     PRINT
2550     INPUT "Input the first letter of a word [B/J]",File_type$
2560     !
2570 Input_name:!
2580     INPUT "Input data file name without extension you wish to
save.",File$
2590     File$=" "&File$&" "
2600     PRINT "file name : "&File$
2610     PRINT
2620     INPUT "Do you want to change file name again?
[Y/N]",Inp_chr$
2630     IF UPC$(Inp_chr$)="N" THEN
2640         IF UPC$(Inp_chr$[1,1])="B" THEN
2650             OUTPUT @Agte4991a;"MMEM:STOR:GRAP:BMP "&File$
2660         ELSE
2670             OUTPUT @Agte4991a;"MMEM:STOR:GRAP "&File$
2680         END IF
2690         OUTPUT @Agte4991a;"SYST:ERR?"
2700         ENTER @Agte4991a;Err_no,Err_mes$
2710         IF Err_no<>0 THEN

```

## Save and Recall Files

### Example Programs for Saving/Recalling a File

```
2720         BEEP
2730         PRINT Err_mes$&" occured"
2740         PRINT
2750         GOTO Input_name
2760     ELSE
2770         PRINT "save done"
2780         PRINT
2790     END IF
2800 ELSE
2810     GOTO Input_name
2820 END IF
2830 SUBEND
```

### Example program using macro (E4991A VBA)

Example 8-2 shows an example program for saving/recalling a file using a Macro. This program is saved under the filename `save_rec.bas` on the sample programs disk. Below is an explanation of the program's details.

- Lines 80 - 400      User selects the menu item for saving/recalling the specified file and changes the current folder.
- Lines 460 - 730    Displays the current folder and makes changes in it in the procedure (`Chn_curr_holder`). Asks to input the file name again if the folder name is inappropriate.
- Lines 750 - 1020   Saves the state file under any filename in the procedure (`Save_state`). Asks to input the file name again if an error occurs while saving the file.
- Lines 1040 - 1320   Recalls the state file in the procedure (`Recall_state`). Asks to input the filename again if an error occurs while recalling the file.
- Lines 1340 - 1880   Saves the data file under any filename in the procedure (`Save_data`). Before saving, selects the kind of internal data array to be saved in the file and the file type (ASCII or binary). Asks to input the filename again if an error occurs while saving the file.
- Lines 1900 - 2170   Recalls the data file (in binary format) in the procedure (`Recall_data`). Asks to input the file name again if an error occurs while recalling the file.
- Lines 2190 - 2550   Saves the CITIfile under any filename in the procedure (`Save_citi`). Selects a model type for the CITIfile before saving. Asks to input the filename again if an error occurs while saving the file.
- Lines 2570 - 2950   Saves the graphics file under any filename in the procedure (`Save_graphics`). Selects saving the measurement display in either bitmap format or JPEG format. Asks to input the file name again if an error occurs while saving the file.

#### Example 8-2      Saving/Recalling (macro)

```

10      Sub Main()
20          Dim msg1 As String, msg2 As String, msg3 As String
30          Dim msg4 As String, msg5 As String, msg6 As String
40          Dim msg7 As String, msg8 As String, msg9 As String
50          Dim msg10 As String
60          Dim ans As String
70
80      menu:
90          msg1 = "                      Save/Recall Menu" & vbCrLf
100          msg2 = "-----" & vbCrLf
110          msg3 = "1: returns/changes current holder" & vbCrLf
120          msg4 = "2: saves state file" & vbCrLf
130          msg5 = "3: recalls state file" & vbCrLf
140          msg6 = "4: saves data file" & vbCrLf
150          msg7 = "5: recall data file" & vbCrLf
160          msg8 = "6: saves CITIfile" & vbCrLf
170          msg9 = "7: saves graphics data file" & vbCrLf
180          msg10 = "8: quit" & vbCrLf
190          ans = InputBox(msg1 & msg2 & msg3 & msg4 & msg5 & msg6 &

```

## Save and Recall Files

### Example Programs for Saving/Recalling a File

```
msg7 & msg8 & msg9 & msg10, "file menu")
200
210     Select Case ans
220     Case "1"
230         Call chn_curr_holder
240     Case "2"
250         Call save_state
260     Case "3"
270         Call recall_state
280     Case "4"
290         Call save_data
300     Case "5"
310         Call recall_data
320     Case "6"
330         Call save_citi
340     Case "7"
350         Call save_graphics
360     Case "8", ""
370         GoTo menu_end
380     End Select
390
400     GoTo menu
410
420 menu_end:
430     End
440 End Sub
450
460 Private Sub chn_curr_holder()
470     Dim msg As String, holder As String, err_mes As String
480     Dim err_no As Integer
490
500     SCPI.Output "MMEM:CDIR?"
510     SCPI.Enter holder
520     input_name:
530     msg = "current holder name: " & holder & vbCrLf & vbCrLf &
540     "Do you want to change the current holder?"
550     ans = MsgBox(msg, vbYesNo)
560     If ans = vbYes Then
570         msg = "Input new current holder name you wish."
580         holder = InputBox(msg, "holder name")
590         If holder = "" Then GoTo input_end
600         holder = "" & holder & ""
610         SCPI.Output "*CLS"
620         SCPI.Output "MMEM:CDIR " & holder
630         SCPI.Output "SYST:ERR?"
640         SCPI.Enter err_no, "#"
650         SCPI.Enter err_mes
660         If err_no <> 0 Then
670             MsgBox (err_mes & "occured")
680             GoTo input_name
690         ElseIf err_no = 0 Then
700             MsgBox ("new holder name: " & holder)
710         End If
720     End If
730     input_end:
740 End Sub
750 Private Sub save_state()
```



```

760     Dim msg As String, file As String, err_mes As String
770     Dim err_no As Integer
780
790     input_name:
800     msg = "Input the state file name without extension you wish
to save."
810     file = InputBox(msg, "file name")
820     If file = "" Then GoTo input_end
830     file = "" & file & ""
840     msg = "file name : " & file & vbCrLf & vbCrLf & "Do you
want to change the file name again?"
850     ans = MsgBox(msg, vbYesNo)
860     If ans = vbNo Then
870         SCPI.Output "*CLS"
880         SCPI.Output "MMEM:STOR " & file
890         SCPI.Output "SYST:ERR?"
900         SCPI.Enter err_no, "#"
910         SCPI.Enter err_mes
920         If err_no <> 0 Then
930             MsgBox (err_mes & "occured")
940             GoTo input_name
950         ElseIf err_no = 0 Then
960             MsgBox ("save done")
970         End If
980     ElseIf ans = vbYes Then
990         GoTo input_name
1000    End If
1010    input_end:
1020    End Sub
1030
1040    Private Sub recall_state()
1050        Dim msg As String, file As String, err_mes As String
1060        Dim err_no As Integer
1070
1080        input_name:
1090        msg = "Input the state file name without extension you
wish to recall."
1100        file = InputBox(msg, "file name")
1110        If file = "" Then GoTo input_end
1120        file = "" & file & ""
1130        msg = "file name : " & file & vbCrLf & vbCrLf & "Do you
want to change the file name again?"
1140        msg = "Do you want to change file name again?"
1150        ans = MsgBox(msg, vbYesNo)
1160        If ans = vbNo Then
1170            SCPI.Output "*CLS"
1180            SCPI.Output "MMEM:LOAD " & file
1190            SCPI.Output "SYST:ERR?"
1200            SCPI.Enter err_no, "#"
1210            SCPI.Enter err_mes
1220            If err_no <> 0 Then
1230                MsgBox (err_mes & "occured")
1240                GoTo input_name
1250            ElseIf err_no = 0 Then
1260                MsgBox ("recall done")
1270            End If
1280        ElseIf ans = vbYes Then
1290            GoTo input_name

```

## Save and Recall Files

### Example Programs for Saving/Recalling a File

```
1300     End If
1310     input_end:
1320     End Sub
1330
1340     Private Sub save_data()
1350         Dim msg As String, file As String, file_type As String
1360         Dim err_mes As String, bool As String
1370         Dim i As Integer, err_no As Integer
1380
1390         For i = 1 To 4
1400             Select Case i
1410                 Case 1
1420                     ans = MsgBox("Do you want to save the data array?",
vbYesNo)
1430                 Case 2
1440                     ans = MsgBox("Do you want to save the data trace
array?", vbYesNo)
1450                 Case 3
1460                     ans = MsgBox("Do you want to save the memory array?",
vbYesNo)
1470                 Case 4
1480                     ans = MsgBox("Do you want to save the memory trace
array?", vbYesNo)
1490             End Select
1500             If ans = vbYes Then
1510                 SCPI.Output "MMEM:STOR:TRAC:SEL" & CStr(i) & " ON"
1520             ElseIf ans = vbNo Then
1530                 SCPI.Output "MMEM:STOR:TRAC:SEL" & CStr(i) & " OFF"
1540             End If
1550         Next i
1560
1570         msg = "Select the File type, ASCII or Binary." & vbCrLf &
vbCrLf & "Input the first letter of a word [A/B]"
1580         file_type = InputBox(msg, "file type")
1590         If file_type = "" Then GoTo input_end
1600
1610         input_name:
1620         msg = "Input the data file name without extension you wish
to save."
1630         file = InputBox(msg, "file name")
1640         If file = "" Then GoTo input_end
1650         file = "" & file & ""
1660         msg = "file name : " & file & vbCrLf & vbCrLf & "Do you
want to change the file name again?"
1670         ans = MsgBox(msg, vbYesNo)
1680         If ans = vbNo Then
1690             SCPI.Output "*CLS"
1700             If UCase(file_type) = "A" Then
1710                 SCPI.Output "MMEM:STOR:TRAC:ASC " & file
1720             ElseIf UCase(file_type) = "B" Then
1730                 SCPI.Output "MMEM:STOR:TRAC " & file
1740             End If
1750             SCPI.Output "SYST:ERR?"
1760             SCPI.Enter err_no, "#"
1770             SCPI.Enter err_mes
1780             If err_no <> 0 Then
1790                 MsgBox (err_mes & "occured")
1800             GoTo input_name
```

```

1810         ElseIf err_no = 0 Then
1820             MsgBox ("save done")
1830         End If
1840     ElseIf ans = vbYes Then
1850         GoTo input_name
1860     End If
1870 input_end:
1880 End Sub
1890
1900 Private Sub recall_data()
1910     Dim msg As String, file As String, err_mes As String
1920     Dim err_no As Integer
1930
1940     input_name:
1950     msg = "Input the binary data file file name without
extension you wish to recall."
1960     file = InputBox(msg, "file name")
1970     If file = "" Then GoTo input_end
1980     file = "" & file & ""
1990     msg = "Do you want to change the file name again?"
2000     ans = MsgBox(msg, vbYesNo)
2010     If ans = vbNo Then
2020         SCPI.Output "*CLS"
2030         SCPI.Output "MMEM:LOAD:TRAC " & file
2040         SCPI.Output "SYST:ERR?"
2050         SCPI.Enter err_no, "#"
2060         SCPI.Enter err_mes
2070         If err_no <> 0 Then
2080             MsgBox (err_mes & "occured")
2090             GoTo input_name
2100         ElseIf err_no = 0 Then
2110             MsgBox ("recall done")
2120         End If
2130     ElseIf ans = vbYes Then
2140         GoTo input_name
2150     End If
2160 input_end:
2170 End Sub
2180
2190 Private Sub save_citi()
2200     Dim msg1 As String, msg2 As String, msg3 As String, msg4
As String
2210     Dim file As String, model As String
2220     Dim err_mes As String, bool As String
2230     Dim err_no As Integer
2240
2250     input_name: '
2260     msg1 = "Select the model of the CITIfile as follows
[1-3];" & vbCrLf & vbCrLf
2270     msg2 = "1: 1 port" & vbCrLf
2280     msg3 = "2: 2 port Series" & vbCrLf
2290     msg4 = "3: 2 port Shunt"
2300     model = InputBox(msg1 & msg2 & msg3 & msg4, "CITIfile
type")
2310     If model = "" Then GoTo input_end
2320
2330     msg = "Input CITIfile name without extension you wish to
save."

```

## Save and Recall Files

### Example Programs for Saving/Recalling a File

```
2340     file = InputBox(msg, "file name")
2350     If file = "" Then GoTo input_end
2360     file = "" & file & ""
2370     msg = "file name : " & file & vbCrLf & vbCrLf & "Do you
want to change the file name again?"
2380     ans = MsgBox(msg, vbYesNo)
2390     If ans = vbNo Then
2400         SCPI.Output "*CLS"
2410         SCPI.Output "MMEM:STOR:CITI" & CStr(model) & " " & file
2420         SCPI.Output "SYST:ERR?"
2430         SCPI.Enter err_no, "#"
2440         SCPI.Enter err_mes
2450         If err_no <> 0 Then
2460             MsgBox (err_mes & "occured")
2470             GoTo input_name
2480         ElseIf err_no = 0 Then
2490             MsgBox ("save done")
2500         End If
2510     ElseIf ans = vbYes Then
2520         GoTo input_name
2530     End If
2540 input_end:
2550 End Sub
2560
2570 Private Sub save_graphics()
2580     Dim msg As String, file As String, file_type As String
2590     Dim err_mes As String, bool As String
2600     Dim err_no As Integer
2610
2620     msg = "Select the File type, BMP or JPEG." & vbCrLf &
vbCrLf & "Input the first letter of a word [B/J]"
2630     file_type = InputBox(msg, "file type")
2640     If file_type = "" Then GoTo input_end
2650
2660     input_name:
2670     msg = "Input the graphics file name without extension you
wish to save."
2680     file = InputBox(msg, "file name")
2690     If file = "" Then GoTo input_end
2700     file = "" & file & ""
2710     msg = "file name : " & file & vbCrLf & vbCrLf & "Do you
want to change the file name again?"
2720     ans = MsgBox(msg, vbYesNo)
2730     If ans = vbNo Then
2740         SCPI.Output "*CLS"
2750         If UCase(file_type) = "B" Then
2760             SCPI.Output "MMEM:STOR:GRAP:BMP " & file
2770         ElseIf UCase(file_type) = "J" Then
2780             SCPI.Output "MMEM:STOR:GRAP " & file
2790         End If
2800         SCPI.Output "SYST:ERR?"
2810         SCPI.Enter err_no, "#"
2820         SCPI.Enter err_mes
2830         If err_no <> 0 Then
2840             MsgBox (err_mes & "occured")
2850             GoTo input_name
2860         ElseIf err_no = 0 Then
2870             MsgBox ("save done")
```

```
2880     End If
2890     ElseIf ans = vbYes Then
2900         GoTo input_name
2910     End If
2920
2930 input_end:
2940
2950 End Sub
```

Save and Recall Files

**Example Programs for Saving/Recalling a File**

---

**9****Using Printer**

This chapter explains how to use a printer connected to the Agilent E4991A to print out measurement results and other information from the instrument.

---

## Printing out to a Printer Connected to E4991A

The E4991A allows the user to print out, for example, the graphical images displayed on the LCD screen. For details on how to connect a printer and available printers, refer to the **operation manual**.

### Selecting Print Contents

The following information can be printed out to a printer.

Print Content	Description
Graphical images on the screen	When a measurement data graph is displayed, graphical images are printed out in either color or monochrome.
Measurement result list	Measurement data at all measurement points are printed out in text format in monochrome only.
Settings information	Major setting parameters are printed out in text format in monochrome only.

Use the following command to select the desired print content.

- **HCOP:CONT** on page 380

### Selecting Color

The following command can be used to select the color in which the chosen content is printed. If print content other than graphical images is selected, it can only be printed in monochrome regardless of the command parameter.

- **HCOP:IMAG** on page 381

Color	Description
Color (Inverted color)	Printed in inverted screen color.
Monochrome (Reverse video)	Printed in gray scale inversion.

### Performing Printout

Use the following GPIB command to print out the information to a printer.

- **HCOP** on page 380

### Cancelling Printing

Use the following GPIB command to cancel printing.

- **HCOP:ABOR** on page 380



---

## **10**      **Setting the Display**

This chapter explains how to set the display screen of the Agilent E4991A.

## Setting the Display

The E4991A provides several GPIB commands that can be applied to the entire screen (all windows) or to a specific trace.

### GPIB Commands for Entire Screen (windows)

#### Enable/Disable Update of Displayed Information

The following GPIB command can be used to enable/disable update of the entire screen.

- **DISP:ENAB** on page 354

#### Switch between Split Window and Overlay (Scalar Trace)

When several traces are displayed in a scalar trace, the following GPIB command can be used to select whether one trace is displayed within one of the split windows or all of the traces are displayed overlaid in one window.

- **DISP:FORM** on page 355

#### Disable Backlight

The E4991A is equipped with an LCD with a backlight for increased visibility. The following GPIB command can be used to switch between turning the backlight on and off. Note that disabling the backlight results in no visibility.

- **DISP:BACK** on page 354

### GPIB Commands for Traces

#### Set Active Trace

Use the following GPIB command to set the active trace.

- **DISP:TRAC{1-5}:SEL** on page 358

#### Select Measurement Display Screen

Use the following GPIB command to select whether the measurement screen is displayed in the graph or text (list) format.

- **DISP:TRAC{1-5}:TEXT** on page 359

In the text format, the following GPIB command can be used to scroll through the screen.

- **DISP:TRAC{1-5}:TEXT:PAGE** on page 359

### Use Memory Trace

Use the following GPIB command to copy the measurement data to the memory trace.

- **CALC{1-5}:MATH:MEM** on page 341

### Select Trace to Be Displayed

If measurement data is not copied to memory, only the data trace can be displayed on the screen. If measurement data is copied to memory, one of the following can be selected for display on the screen.

- Data trace
- Memory trace
- Data trace and memory trace
- Operation results between data trace and memory trace

Use the following GPIB command to select the trace(s) to be displayed.

- **CALC{1-5}:MATH:FUNC** on page 340

### Set Offset (Scalar Trace)

Scalar trace allows you to display the results obtained by subtracting any offset value from a data trace value. Use the following GPIB command to set the offset value. Note that the offset value can be set for each parameter.

- **CALC{1-3}:MATH:OFFS** on page 342

### Enter and Display Trace Title

Any title can be displayed in the title area at the top of the window.

Use the following GPIB command to enter a title (string).

- **DISP:TRAC{1-5}:TITL:DATA** on page 361

Use the following GPIB command to display the title.

- **DISP:TRAC{1-5}:TITL** on page 360

## When Data Trace Is Refreshed

The timing used for refreshing the data trace can be set to any point. When you want to update trace data frequently, use the following GPIB command to specify when it should be refreshed.

### Refresh for Each Sweep

Use the following GPIB command to specify that the data trace be refreshed each time sweep is completed.

- **SYST:IND:SWE:SET** on page 519

### Refresh for Each Measurement Point

Use the following GPIB command to specify that the data trace be refreshed each time measurement is completed at a measurement point.

- **SYST:IND:POIN:SET** on page 519

### Refresh Periodically

Use the following GPIB command to specify that the data trace be refreshed periodically regardless of measurement.

- **SYST:IND:TIME:SET** on page 521

If the data trace display is refreshed periodically, use the following GPIB command to set the interval.

- **SYST:IND:TIME** on page 520

---

# 11 Error Handling

This chapter describes how the Agilent E4991A handles errors in program execution.

## Using the Error Queue

The error queue contains the error numbers and messages of any errors that have occurred, which could provide very useful information depending on the circumstances. Use the following GPIB command to read the error queue.

- **SYST:ERR?** on page 517

Also, the following GPIB command can be used to obtain the number of errors in the queue.

- **SYST:ERR:COUN?** on page 518

The error queue can be used in the following ways.

1. Based on the information from the error queue, you can decide how to branch a program. By reading the error queue, you can easily determine whether an error has occurred; if no error has occurred, an error number of 0 and an error message of “No error” are returned. The error queue can also be used to set a program to perform error handling only when a certain type of error occurs.
2. If an error is detected using SRQ, the error queue can be used to investigate the type of error. For how to use SRQ, refer to Example 11-1.

## Using Status Report Mechanism

The E4991A's status can be monitored through a set of status registers. The Standard Event Status Register indicates whether an error has occurred. A program uses SRQ (Service Request) to detect an error based on the information from these registers.

To detect an error with SRQ, use the following GPIB commands.

- **\*SRE** on page 283
- **\*ESE** on page 280

Then perform the following procedure.

- Step 1.** Configure the E4991A to generate SRQ when one of the error bits in the Standard Event Status Register is set to 1.
- Step 2.** When SRQ is generated, a program generates an interrupt.

**Figure 11-1** SRQ Generation Sequence (when error has occurred)

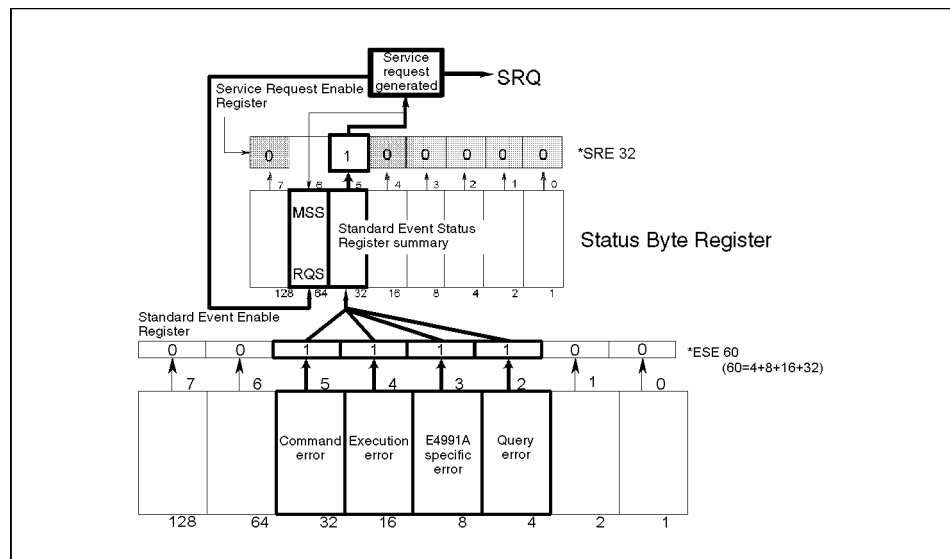

e4991ape001

## Example Program for Error Handling

### Using HTBasic

Example 11-1 shows a program that uses SRQ to detect an error. This program is saved as error.htb on the sample programs disk.

After setting SRQ, this program intentionally generates an error by issuing an invalid command not provided by the E4991A and performs error handling. In the error handling, it reads the error queue to investigate and display an error number and an error message as well as outputs a message to the effect that the program will be aborted.

Line 40	Sets the GPIB address of the E4991A attached to the GPIB interface card with the select code of 7.
Lines 60 - 70	Enables the bits 2,3,4, and 5 of the Standard Event Status Register and sets the bit 5 of the Service Request Enable Register to 1.
Lines 80 - 100	Clears the Status Byte Register, the Standard Event Status Register, and the error queue.
Lines 120 - 130	Causes a branch when an interrupt is generated on the interface card with the select code of 7 and enables SRQ interrupt.
Lines 140 - 210	Sets sweep type and start and stop values of the frequency sweep range, but the invalid command to set the stop value causes an error.
Line 220	Skips the error handling process when no error occurs.
Lines 230 - 250	Error handling. The GO TO statement defined in Line 120 causes the program to branch here. The number and the message of the error that has occurred are read.
Lines 260 - 280	Displays a message saying that an error has occurred, an error number, error description, and a message saying that the program is aborted.
Line 300	Displays a message saying that the program has ended. However, the program does not actually reach this point unless you repair the program and rerun it.

#### Example 11-1

#### Error Detection Using SRQ

```
10 DIM Buff$(9),Err_mes$(50)
20 INTEGER Err_no
30 !
40 ASSIGN @Agte4991a TO 717
50 !
60 OUTPUT @Agte4991a;"*ESE 60"
70 OUTPUT @Agte4991a;"*SRE 32"
80 OUTPUT @Agte4991a;"*CLS"
90 OUTPUT @Agte4991a;"*OPC?"
100 ENTER @Agte4991a;Buff$
110 !
120 ON INTR 7 GOTO Err_proc
130 ENABLE INTR 7;2
140 OUTPUT @Agte4991a;"SWE:TYPE LOG"
150 PRINT "Set Sweep Type :LOG"
```



```
160 OUTPUT @Agte4991a;"FREQ:STAR 1MHZ"  
170 PRINT "Set Start Frequency:1MHz"  
180 OUTPUT @Agte4991a;"FREQ*STOP 3GHZ"  
190 PRINT "Set Stop Frequency :3GHZ"  
200 OUTPUT @Agte4991a;"*OPC?"  
210 ENTER @Agte4991a;Buff$  
220 GOTO Skip_err_proc  
230 Err_proc: OFF INTR 7  
240 OUTPUT @Agte4991a;"SYST:ERR?"  
250 ENTER @Agte4991a;Err_no,Err_mes$  
260 PRINT "Error occurred!!"  
270 PRINT " No: ";Err_no,"Description: "&Err_mes$  
280 PRINT "PROGRAM INTERRUPT!!"  
290 GOTO Prog_end  
300 Skip_err_proc: PRINT "PROGRAM DONE!"  
310 Prog_end: END
```

## Error Handling

### Example Program for Error Handling

#### Using the macro (E4991A VBA)

Example 11-2 shows a program that uses an event to detect an error from the E4991A. This program performs error handling when the E4991A shows a measurement failure. It generates an error message and stops execution of the macro.

This program is saved as error.bas (lines 10 - 300) and bsc\_meas.cls (lines 1000 - 4050) on the sample programs disk.

Lines 40 - 50	Defines the variable Err to use for the event created in the class module (class name: clsErr). Next, sets the object variable (Err.Evnt) to the E4991A library.
Line 130	Clears the Status Byte Register, the Standard Event Status Register, and the error queue.
Lines 140 - 160	Turns on Trace 1 and activates the sweep averaging function.
Lines 180 - 200	Sets the trigger source for the internal trigger and turns off the continuous activation of the trigger system. Then, resets the trigger system and sets the trigger sequence to the idle state.
Lines 220 - 230	Reads the on/off status of the sweep averaging function and substitutes a variable for the status. Next, when the sweep averaging function is set on, resets the averaging and returns the averaging counter to zero.
Lines 250 - 260	Starts the sweep and substitutes a variable for sweep completion. Displays a message of "Sweep Aborted" when sweep is aborted during the measurement.
Line 280	Disassociates the object variable used for the event function.
Line 1000	Defines the variable (Evnt) as the Public type so that the event procedure can be used in different procedures.
Lines 2000 - 2050	Terminates the program when a "PLL unlock" error occurs inside the E4991A.
Lines 3000 - 3050	Terminates the program when a "DC bias overload" error occurs inside the E4991A.
Lines 4000 - 4050	Forces the program to end when the "RF overload" error occurs inside the E4991A.

#### Example 11-2

#### Error Detection Using Event

```
10      Sub Main()  
20          Dim trc As Integer  
30          Dim swp_count As Integer, swp_bool As Integer, bool As  
Integer  
40  
50          Dim Err As New clsErr  
60          Set Err.Evnt = New E4991ALib.Application  
70  
80          trc = 1  
90          swp_count = 16  
100  
110         ' E4991A settings  
120  
130         SCPI.Output "*CLS"  
140         SCPI.Output "DISP:TRAC" & CStr(trc) & " ON"
```

```

150     SCPI.Output "CALC:AVER:COUN " & CStr(swp_count)
160     SCPI.Output "CALC:AVER ON"
170
180     SCPI.Output "TRIG:SOUR INT"
190     SCPI.Output "INIT:CONT OFF"
200     SCPI.Output "ABOR"
210
220     swp_bool = SCPI.Query("CALC:AVER?")
230     If swp_bool = 1 Then SCPI.Output "CALC:AVER:CLE"
240
250     bool = SingleMeasure
260     If bool = 0 Then MsgBox ("Sweep Aborted")
270
280     Set Err.Evnt = Nothing
290
300 End Sub

1000    Public WithEvents Evnt As E4991ALib.Application

2000    Private Sub Evnt_Unlocked()
2010
2020        MsgBox "Error: PLL Unlock" & vbCrLf & vbCrLf & "Program
interruption", vbExclamation, "E4991A Internal Error"
2030        End
2040
2050    End Sub

3000    Private Sub Evnt_DcBiasOverload()
3010
3020        MsgBox "Error: Dc bias overload" & vbCrLf & vbCrLf &
"Program interruption", vbExclamation, "E4991A Internal Error"
3030        End
3040
3050    End Sub

4000    Private Sub Evnt_RfOverload()
4010
4020        MsgBox "Error: RF overload" & vbCrLf & vbCrLf & "Program
interruption", vbExclamation, "E4991A Internal Error"
4030        End
4040
4050    End Sub

```

Error Handling  
**Example Program for Error Handling**

---

## 12 Shutting Down the Instrument

This chapter explains how to properly shut down the Agilent E4991A.

## Shutdown Procedure

The following GPIB command can be used to remotely shut down the E4991A. This command cannot be used to the instrument's power on.

- **SYST:POFF** on page 523

When the above command is used to shut down the E4991A, the standby switch remains pressed, unlike when the instrument is shut down by using the standby switch on the front panel. To turn the power on again from this state, use one of the following methods.

- Return the standby switch to the off state and then turn it on again.
- Stop supplying power to the E4991A and then supply power again. The simplest way to do this is to unplug the power cord attached to the rear panel.

---

### NOTE

Once the above command is executed, the same shutdown process of the E4991A is performed as when the standby switch is pressed. For details on cautions when shutting down the instrument, refer to the *Operation Manual*.

---

---

## 13 Use of Macros

This chapter explains how to use the macro function of the Agilent E4991A to create macro programs with the Visual Basic editor. Information is also given on how to execute produced macros.

## Overview of Macros

The E4991A is loaded with a macro function. A macro program allows you to automatically execute a series of multiple commands by performing a single command. A macro allows you to combine the steps in a complicated procedure into a single step for a wide variety of applications as well as to control peripheral equipment.

E4991A VBA (Visual BASIC for Application), which is based on Microsoft's Visual Basic, is the programming language used to execute macro functions. Macro commands are written with the Visual Basic Editor (VBE). However, this manual does not explain issues such as basic E4991A VBA programming, standard control, and functions. For more details, please refer to the E4991A VBA on-line help. You can also find up-to date information on VB from a variety of recent books, including the official manual issued by Microsoft Co., Ltd. Another information source is the Internet, including Microsoft's web page at the following URL:

<http://msdn.microsoft.com/vbasic>



---

## Macro Function Overview

By using the macro function, you can execute the following operations.

1. Control the E4991A

From E4991A VBA through COM object, you can control the E4991A.

2. Control peripheral equipment

You can use a macro (E4991A VBA) to control peripheral equipment connected through the GPIB interface of the E4991A.

3. Automate formulaic processes that are used repeatedly

By using a macro, you can organize multiple processes of the E4991A into a single process. For example, it is possible to automate the resetting of measurement conditions such as sweep range and measurement averaging numbers within the program and repeat the measurement. This makes operations easier and prevents operation errors from occurring. Also, if you compose the formulaic parts of a program as a module, you can call it for reuse from another program, which can be an effective use of program assets.

4. User interface through dialog boxes

By using the user form, which is one of the key features of E4991A VBA, you can construct a visual user interface. Even if the user is not used to the operations of the E4991A, he or she can follow the direction displayed on the screen, execute the measurement, and input the data. Therefore, you can prevent operation errors due to user mistakes.

## Starting Up and Closing Visual Basic Editor

Visual Basic Editor is software used for making and editing macros. The following procedures explain how to start up and quit Visual Basic Editor.

### Starting up Visual Basic Editor

Start up Visual Basic Editor as follows.

- Step 1.** From the measurement screen of the E4991A, use the following menu command.

**Utility - Visual Basic Editor...**

You can also start the program by typing **[Alt] + [F11]** from the keyboard.

### Quitting Visual Basic Editor

Although Visual Basic is hidden from view, it remains in memory. You can close Visual Basic Editor as follows.

- Step 1.** Use the following menu command. After Visual Basic Editor is closed, the E4991A measurement screen again appears on the display.

**File - Close and Return to E4991A**

You can also quit the program by typing **[Alt] + [Q]** from the keyboard.

### Displaying the E4991A measurement screen

Even if Visual Basic Editor is running, you can still display the E4991A measurement screen.

- Step 1.** From the Visual Basic Editor, use the following menu command.

**View - E4991A**

You can also display the E4991A measurement screen by typing **[Alt] + [F11]** from the keyboard.

## Making/Editing Macros

The actual steps in making macros are briefly explained here. Only the basics of using E4991A VBA are explained, so when you make an actual macro, please refer to E4991A VBA help.

## Elements of Visual Basic Editor

Each major part of Visual Basic Editor and its operations are explained here.

### Tool bar

In the initial setup of Visual Basic Editor, the standard tool bar shown below is displayed. The frequently used commands called by the menu bar are also shown as icons on the tool bar.

The operations of Visual Basic Editor are explained below with reference to the menu bar. Icons on the tool bar naturally operate in the same way as their corresponding menu commands.

**Figure 13-1**

### Standard tool bar

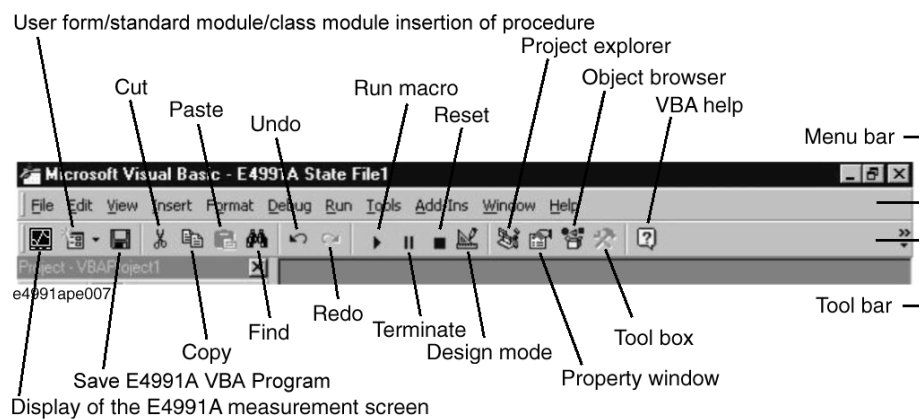

### Window right after startup

When Visual Basic Editor is started up, several windows are initially displayed. Here, the most important windows are described.

- Project explorer

A list of macros (modules) made or loaded by Visual Basic Editor is displayed here. Module is explained under “Module” on page 221.

- Property window

In E4991A VBA, a program is represented on the user form by either a command button, called a “control,” or a text box. For example, you can set up a program to start measurement whenever the command button labeled “Measure” is pressed.

The property window also displays the settings for altering the color and size of controls such as the command buttons on the user form. A control is called an object in E4991A VBA, and the color and size of the object are called properties. In order to set up the value of a property, the following is given.

Object name.Property name = Setting value

For example, in order to display the character string (Caption) reading “Measure” on the command button named “Button,” input the following:

```
Button.Caption = "Measure"
```

For more information on how to prepare various kinds of properties, please refer to the E4991A VBA on-line help.

---

**NOTE**

The property window is only needed when making macros with the user form.

Figure 13-2 Editor screen of Visual Basic right after startup

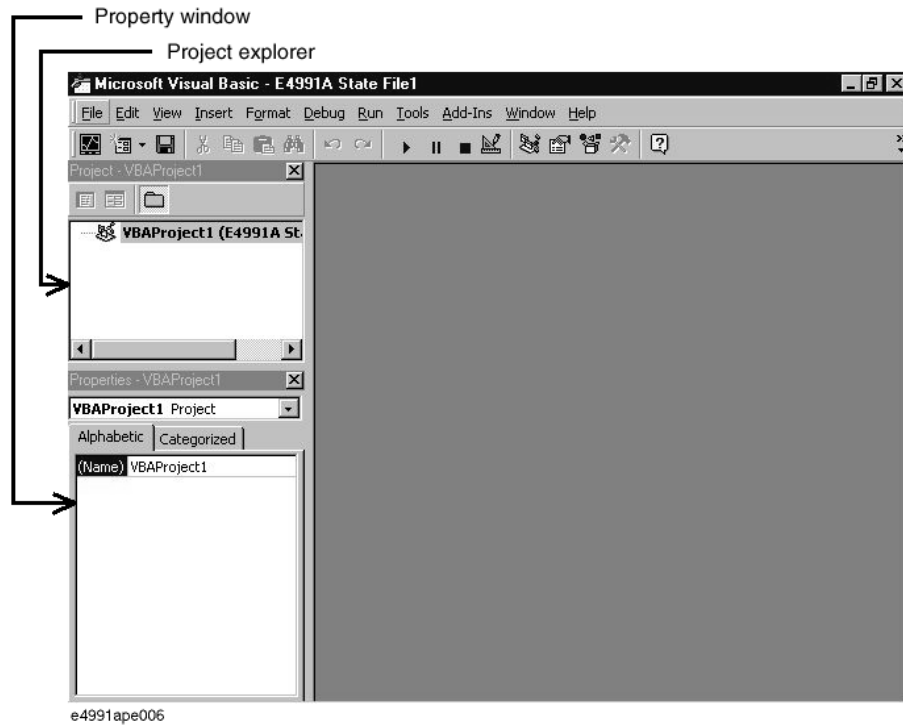

## Use of Macros

### Making/Editing Macros

#### Other windows

The following windows are not displayed after startup of Visual Basic Editor but are needed for programming. Some of the windows displayed in Visual Basic Editor are not introduced here.

- Form designer

By using the form designer, you can make your own user forms. When the corresponding macro is executed, the user form will be displayed on the screen. For example, this is useful for inputting data in a text box on the user form or for executing/ending measurement by clicking a command button.

**Step 1.** The form designer is displayed by the following menu command.

#### Insert - UserForm

- Toolbox

When starting up the form designer, the toolbox is displayed. A user form can be made by freely dragging and dropping command buttons or text boxes. For the types and uses of the prepared controls, please refer to E4991A VBA help.

**Figure 13-3** Form designer/display screen of tool box

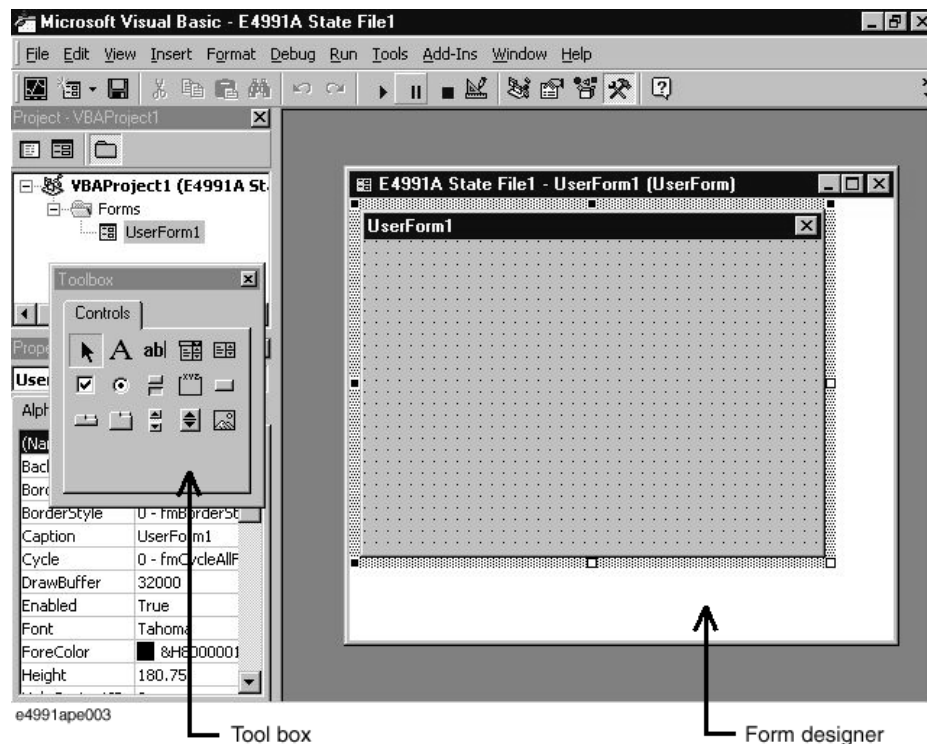

- Code window

The screen used to input program code is the code window. When adding a module to the project, or by double-clicking the control arranged on the user form, the code window is opened. For explanations of each part of the code window, please refer to “Parts of the code window” on page 226.

Figure 13-4 Display screen of code window

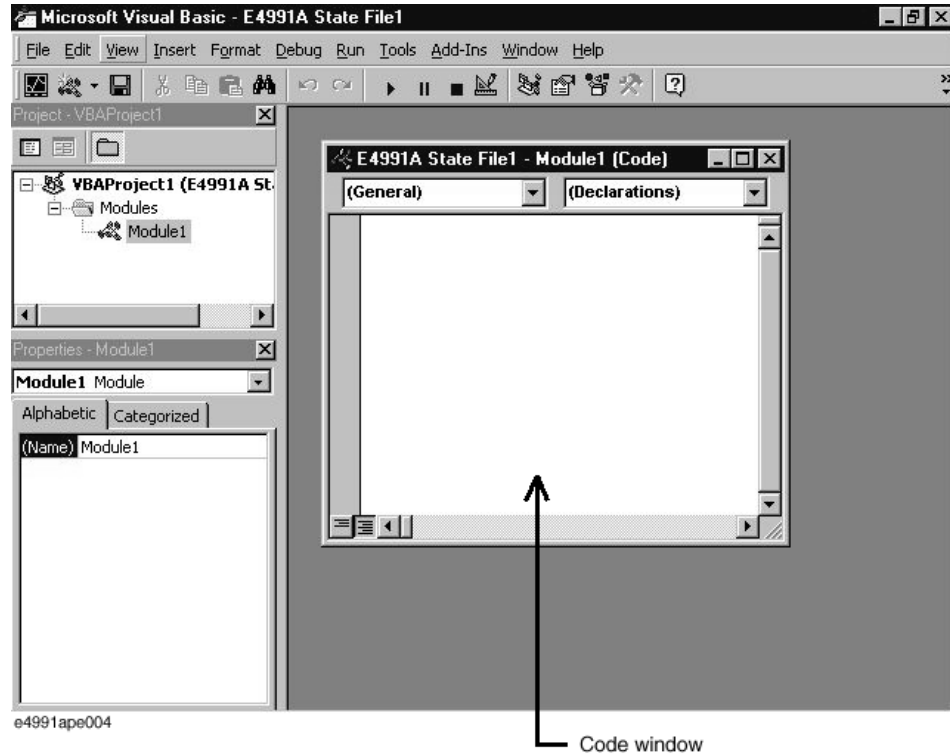

13. Use of Macro

## Use of Macros

### Making/Editing Macros

- Object browser

The object browser provides access to the object and is displayed as follows.

**Step 1.** T object browser can be displayed by the following menu command.

#### View - Object Browser

In E4991A, the settings of measurement conditions and the software for calling measurement values are provided in the form of individual objects for each use. Using the object browser, you can refer to the software objects provided by the E4991A (COM Interface). For details, please refer to “E4991A Library” on page 228.

**Figure 13-5** Display screen of object browser

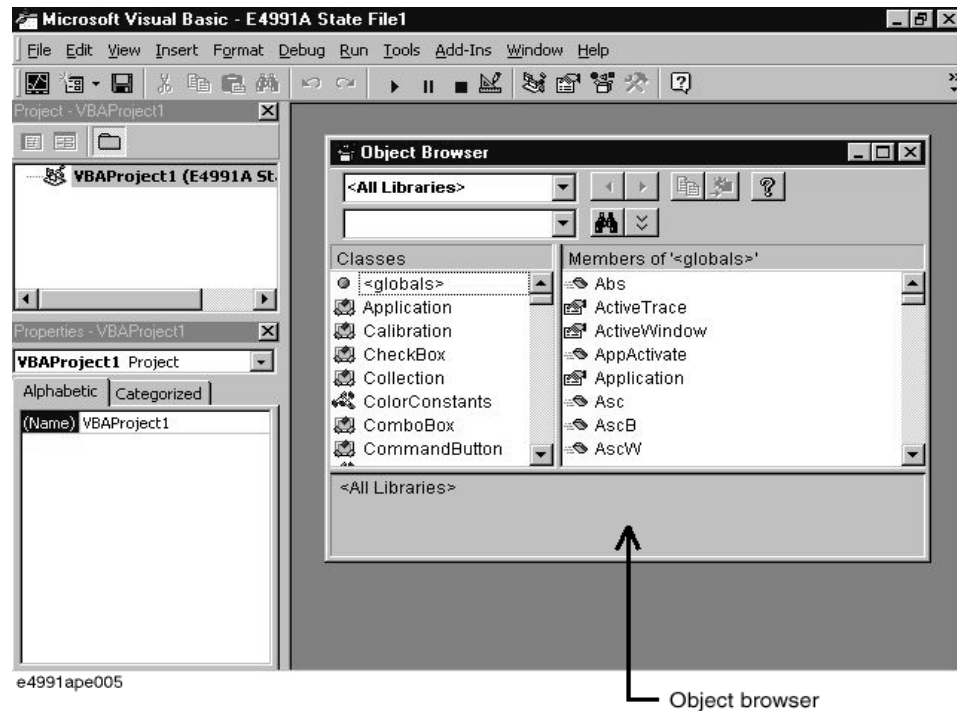

- E4991A VBA help

While using E4991A VBA, you can learn about unfamiliar operations and keywords by checking the E4991A VBA on-line help. For how to use E4991A VBA help, please refer to “Using E4991A VBA Help” on page 234.



### Project and module

In the project explorer, the macro currently used is displayed. Here, the elements of project and module are briefly described.

Figure 13-6

### Example display screen of project explorer

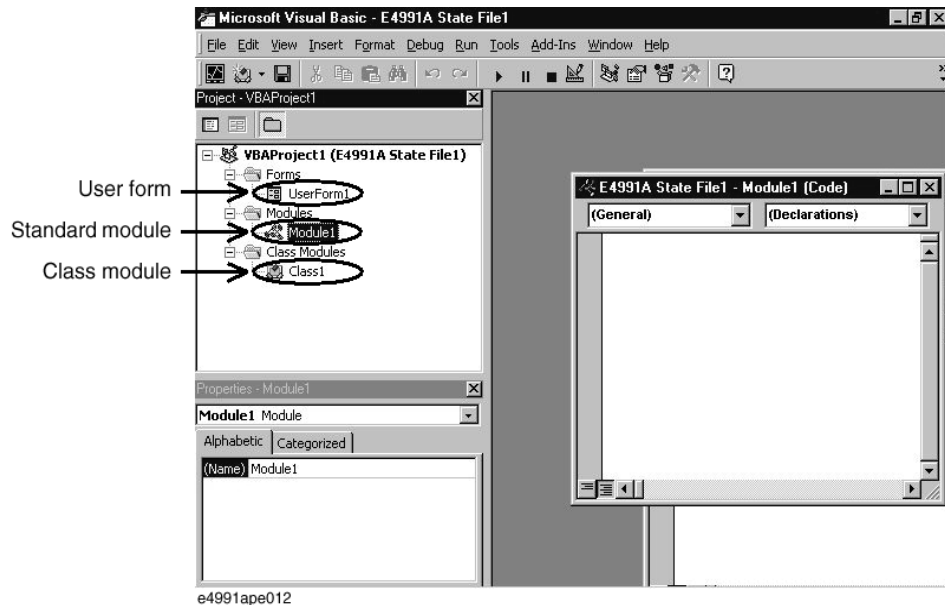

### Project

The element that gathers and manages a macro's module group is called a project. With the E4991A, it is impossible to distinguish and use multiple projects within the project explorer. Therefore, it is necessary to either load a new project into the macro under construction or to insert an existing project into a saved macro. For how to load a macro, please refer to "Loading macros" on page 233.

### Module

You can make a macro by describing code in a module. In the E4991A, the following three types of modules can be used. Each type has its own characteristics as shown below.

- Standard module

Standard module has nothing to do with the user form and is a program composed of less than one procedure (this program is composed of "Sub" to "End Sub"). The extension "\*.bas" is attached to a standard module.

**Step 1.** Standard module is added to a project by the following menu command.

#### Insert - Module

## Use of Macros

### Making/Editing Macros

- User form

The program (procedure) is shown on the control pasted on the user form. The extension “\*.frm” is attached to a user form.

**Step 1.** User form is added to a project by the following menu command.

#### **Insert - UserForm**

After the user form is added, the code window describing its code is not displayed but can be viewed double-clicking on the appropriate control on the user form.

- Class module

Class module is used to make an object in Visual Basic that can be used from another application. This class is actually a template for making an object for Visual Basic. The extension “\*.cls” is attached to a class module.

**Step 1.** Class module is added to a project by the following menu command.

#### **Insert - ClassModule**

### Exporting modules

Saving the created modules individually in folders is called exporting. A module is exported by following the procedure below.

---

**NOTE**

When you export a module, the designated module is saved in a folder but not in the project unit. For how to save a macro in the project unit, please refer to “Saving macros” on page 232.

---

- Step 1.** In the project explorer, right-click on the module you want to export, which will display the shortcut menu.
- Step 2.** Click **Export File...** in the shortcut menu to display the Export File dialogue box.

**Figure 13-7** Example display screen of Export File dialogue box

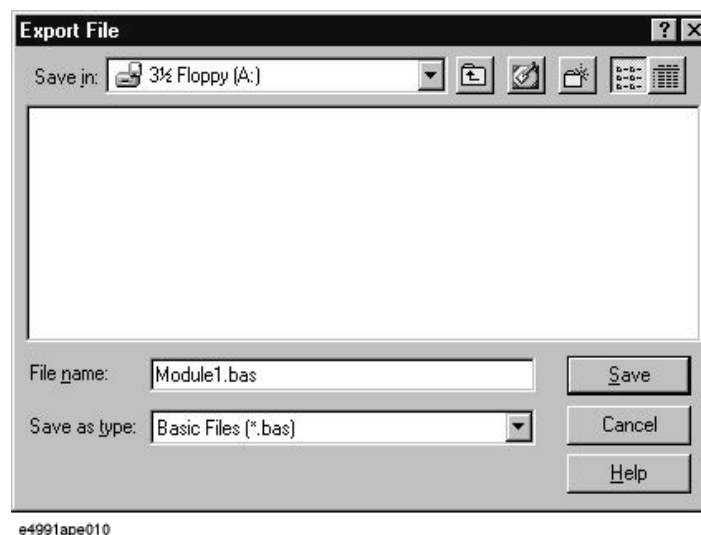

- Step 3.** Click the **Save** button to export the module to the designated folder.

Each part in the Export File dialogue box is explained as follows.

- |                      |  |
|----------------------|--|
| <b>Save In:</b>      | Designate the folder where you want the exported module to reside.   |
| <b>File Name:</b>    | Input the filename of the exported module.   |
| <b>Save as Type:</b> | Select the type of module. When the module you want to export is selected, its corresponding type is displayed, so this setting should be left as it is. |
| <b>Save</b>          | Export the designated module.  |
| <b>Cancel</b>        | Return to the original screen without exporting a module.  |
| <b>Help</b>          | Display the E4991A VBA help screen.  |

### Importing modules

Calling an exported module and inserting it into project is called importing. A module is imported by following the procedure below.

**Step 1.** Display the Import File dialogue box by the following menu command.

**File - Import File...**

Figure 13-8

Example display screen of Import File dialogue box

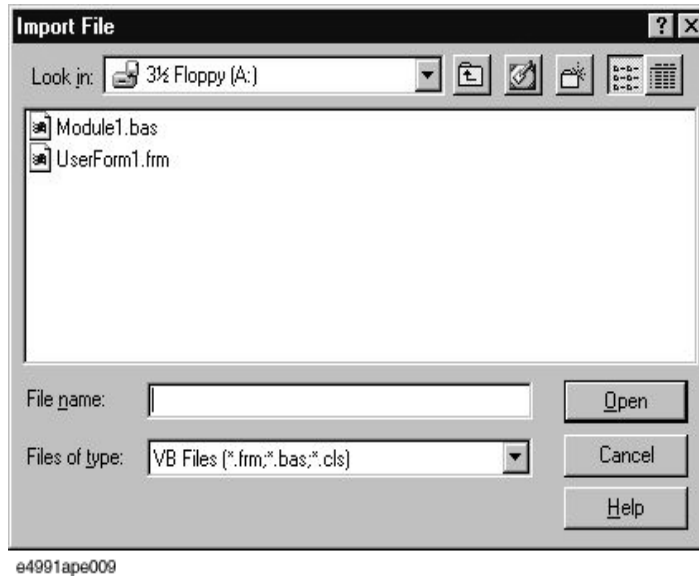

**Step 2.** In the Import File dialogue box, select the file to import. Next, click the **Open** button to import the file into the project.

Each part of the Import File dialogue box is explained as follows.

- |                       |  |
|-----------------------|--|
| <b>Look In:</b>       | Designate the folder where the module is saved.                            |
| <b>File Name:</b>     | Input the filename of the module to save.                                  |
| <b>Files of type:</b> | Select the type of module to import. You can designate any type of module. |
| <b>Open</b>           | Import the module into the project.  |
| <b>Cancel</b>         | Return to the original screen without importing a module.                  |
| <b>Help</b>           | Display the E4991A VBA help screen.  |

### Removing modules

The procedure for removing unnecessary modules from a macro is explained below. In the following example, a standard module called “Module1” is removed.

- Step 1.** In the project explorer, right-click the “Module1” module under the “Modules” icons to display the shortcut menu.
- Step 2.** Next, click **Remove Module1** in the shortcut menu.
- Step 3.** When the next dialog box asks you if you want to export module1 before removing it, click the **No** button.

## Describing macros

The following explains each part of the code window used in making macros and how to describes programs.

### Parts of the code window

You describe macros in the code window. Double-click on any module from the property explorer to open the code window.

Figure 13-9 Example display screen of code window

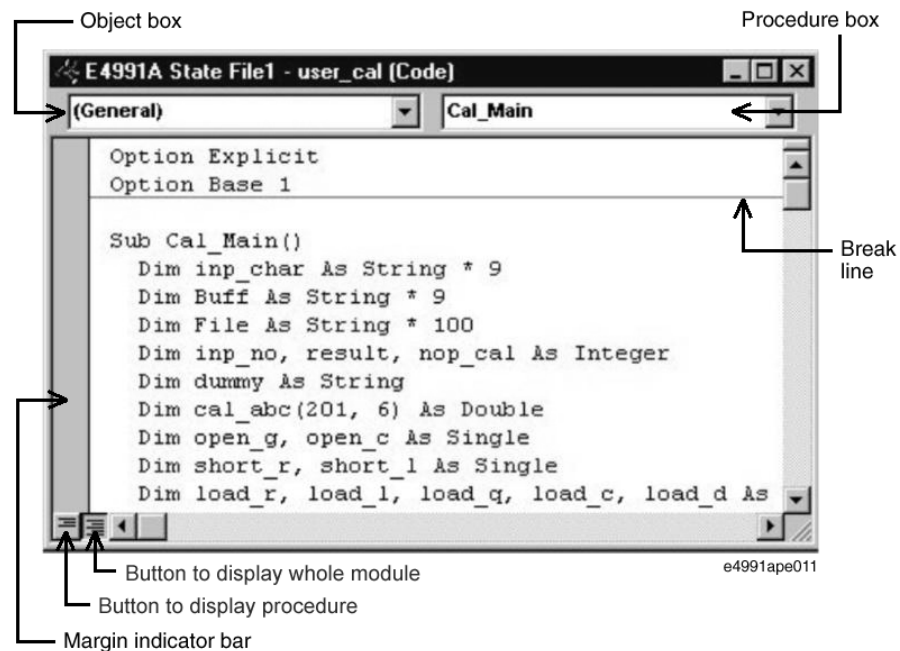

- Object box  
In this list box select the object that you want to display in the code window.
- Procedure box  
In this list box select the procedure that you want to display in the code window.
- Break line  
Used to insert breaks between parts of a macro.
- Margin indicator bar  
Mainly use in debugging.

**Structure of macro**

Each part of a macro is explained by using the following example of a simple macro. The parts of the program are indicated by the numbers to the right in parentheses (these numbers are not used in the actual program).

**Example 13-1****Example of macro program**

```
Sub Sample1() (1)

' Sample Program 1 (2)

Dim i As Integer (3)
Dim total As Integer (3)

total = 0
For i = 1 To 10 Step 1 (4)
    total = total + i (5)
Next i (4)

MsgBox ("Total = " & Val(total)) (6)

End Sub
```

Each part of the above macro is explained as follows.

1. The macro starts with the form of “Sub Sample1()” and ends with “End Sub”. This group is called the procedure. Here, “Sample1” is a procedure name.
2. Everything written to the right of the comment symbol (') is a comment.
3. The type of parameter is declared by a Dim statement. Here, a command is called a statement. In the program example, the variables of “i” and “total” are declared by the type of integer. For more on statements prepared by E4991A VBA and the types of parameters handled in E4991A VBA, please refer to E4991A VBA help.
4. By using a For...Next statement, a loop is executed a fixed number of times.
5. “total” plus “i” equals “Total”. Here, since “i” is used as the fixed number of times in a For...Next statement, the numeric values from 1 to 10 are added to “total” in order.
6. The result of the calculations can be displayed by using the message box function. For more on the functions provided with E4991A VBA, please refer to E4991A VBA help.

---

**NOTE**

In Example 13-1, only a single procedure is explained as an example. The larger a macro gets, the more care needs to be taken in programming, such as when selecting the declaring method for dealing with a parameter between multiple procedures.

---

## E4991A Library

The COM Interface is provided to control the E4991A. In Visual Basic Editor, you can see a list of COM Interfaces that work with the E4991A by opening the object browser while programming. This also displays the VBA Syntax and a simple explanation of the E4991A COM Interface. Since explanations of the E4991A COM Interface are not included in E4991A VBA help, please refer to Chapter 18, “COM Interface Reference,” on page 527.

**Step 1.** Display the object browser by the following menu command.

### View - Object Browser

**Step 2.** Next, select E4991ALib from the Project/Library box to display the E4991A Library.

**Step 3.** Select the COM Interface that you need. Then, the corresponding E4991A VBA Syntax and a simple explanation of the selected COM Interface are displayed in the bottom part of the window.

Figure 13-10

### Example of using Object browser

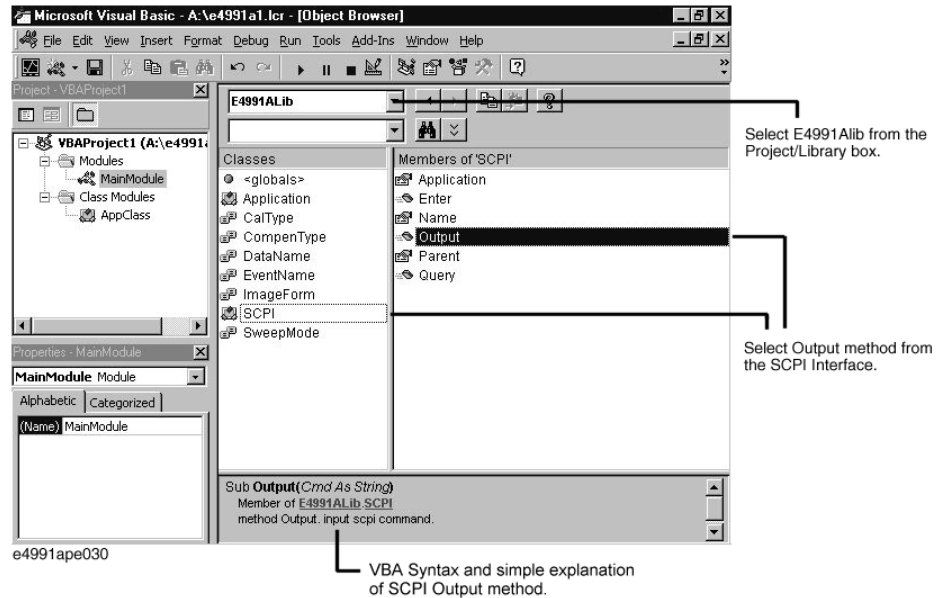

## Macro recording

In VBA, Microsoft Excel supports macro record<sup>\*1</sup>, but the E4991A VBA does not. Therefore, you cannot use this function to record a sequence of front panel key, keyboard, and mouse operations as a macro for later use.

\*1. Function to automatically convert performed operations into a macro by recording them.



## Debugging macros

In order to eliminate disruptive errors (bugs) from macros, the operation of debugging is necessary. E4991A VBA has a tool that can search for bugs and resolve such situations.

### Types of bugs and debugging

The following types of bugs are the most common.

- Syntax error (compile error)

A syntax error occurs by inputting a statement that violates the grammar rules of Visual Basic. For example, an error in spelling is a syntax error. E4991A VBA shows error messages in the error dialogue box and indicates the origin of an error in red. To better understand the details of an error, click the **HELP** button in the error dialogue box. A macro cannot be executed until any syntax error is resolved.

In the initial settings, the function that automatically searches for syntax errors is activated. However, you can freely turn on/off the automatic syntax error checking function.

- Step 1.** In Visual Basic Editor, turn on/off the automatic syntax error checking function by the following menu command.

#### Tools - Options... - Auto Syntax Check

- Execution error

Such errors occur while executing a macro. This type of error normally interrupts the program or ends it at unexpected places. If the program is interrupted, it can be stopped by clicking the **END** button in the error dialogue box. In addition, if the **DEBUG** button is available in the error dialogue box, you can click it to specify the cause of the error. After doing this, the error is highlighted in yellow.

- Logic error

A logic error is a type of human error. For example, programming to control the E4991A might stipulate that dc bias be applied and measured. However, if dc bias is not applied, the expected measurement will not be complete, even though you can execute the macro without any problem. Since E4991A VBA does not return an error in this case, the programmer must specify the cause of the error himself. In order to find the logic error, break points must be set up in suspected places, and the performance is confirmed through stepwise execution of statement performance. E4991A VBA has a debug tool for this purpose. For more on how to use the debug tool, please refer to E4991A VBA help.

- Step 1.** In Visual Basic Editor, you can display the debug tool by the following menu command.

#### View - Tool bars - Debug

## Executing and Terminating Macros

### Executing macros

With the E4991A, macros can be executed in the following four ways.

#### Executing macros from Visual Basic Editor

**Step 1.** You can display the Macros dialogue box by using either of the following methods.

- Type the **[F5]** key from the keyboard.
- Use the **Run - Run** menu command in Visual Basic Editor.

**Step 2.** In the Macros dialogue box, execute the selected macro (procedure). For how to do this operation, please refer to “Display screen right after execution of a macro” on page 231.

#### Executing macros from the E4991A measurement screen

**Step 1.** From the measurement screen of the E4991A, display the Macros dialogue box by the following menu command.

#### Utility - VBA Macros...

**Step 2.** In the Macros dialogue box, execute the selected macro (procedure). For how to do this operation, please refer to “Display screen right after execution of a macro” on page 231.

#### Automatically executing macros during power-up

If a macro meets the following conditions in the “D:\” folder at the time of power-up of the E4991A, the macro (“Start” procedure) is executed automatically.

Macro to be executed	Condition
The folder name where macro is placed	D:\
Name of macro	Autost.lcr
Name of module	Pon
Name of procedure	Start

## Executing macros by GPIB commands

You can execute a macro by using a GPIB command.

First, specify the macro to be executed by using the following GPIB command.

- **PROG:NAME** on page 394

By continuously using the following GPIB command, execute the macro.

- **PROG:STAT** on page 395

## Display screen right after execution of a macro

When you execute a macro, the Macros dialogue box first opens. Specify the macro to be executed in this box. Each part of the Macros dialogue box is explained as follows.

<b>Macro name:</b>	Select the macro (procedure) to be executed from the list box.
<b>Macro in:</b>	Specify the folder where the macro is saved.
<b>Run</b>	Execute the selected macro (procedure).
<b>Cancel</b>	Return to the original screen without executing a macro.
<b>Step into</b>	After the Visual Basic Editor screen is displayed, execute the selected macro line-by-line (step into). This is mainly done when you want to confirm the performance of a macro.
<b>Edit</b>	Use to re-edit the selected macro.
<b>Create</b>	Normally, this button is not available.
<b>Delete</b>	Delete the selected macro.

## Terminating macros

### Stopping macros

The following procedure explains how to stop macros during execution.

**Step 1.** Stop a macro by either of the following methods.

- Type **[Ctrl]** and **[Break]** at the same time from the keyboard.
- Use the **Run - Break** menu command in Visual Basic Editor.

### Abruptly terminating macros

The following procedure explains how to abruptly terminate macros.

**Step 1.** Terminate a macro abruptly by either of the following methods.

- Use *End statement* in the code.
- Use the **Run - Reset** menu command in Visual Basic Editor.

## Saving/Loading Macros

The following explains how to save and load macros in the project unit.

### Saving macros

A macros is saved in a filename with the extension (\*.lcr).

#### Saving from Visual Basic Editor

A macro that has been made or edited is saved by the following procedure.

- Step 1.** Display the Save As dialogue box from the Visual Basic Editor by the using the following menu command.

#### File - Save xxxx

The filename is typed in the “xxxx” part.

- Step 2.** After inputting the filename of a macro and the name of the folder to save it in, click the **Save** button to save the macro.

The following explains each part of the Save As dialogue box.

<b>Save In:</b>	Specify the folder to save the macro in.
<b>File Name:</b>	Input the name of the macro file.
<b>Save as Type:</b>	Select the type of file. Normally, “E4991A Program File [*.lcr]” is selected.
<b>Save</b>	Save the macro into the designated folder.
<b>Cancel</b>	Close the Save As dialogue box and return to the original screen without saving a macro.

### Saving from the E4991A measurement screen

The following procedure can be used to save the macro from the measurement screen of the E4991A.

- Step 1.** Display the Save Program dialogue box from the measurement screen of the E4991A by using the following menu command.

#### Utility - Save Program

- Step 2.** After inputting the filename of the macro and the name of the folder to save it in, click the **OK** button to save the macro.

Each part of the Save Program dialogue box is explained as follows.

<b>Drive:</b>	Specify the folder to save the macro in.
<b>File Name:</b>	Input the filename of the macro.
<b>OK</b>	Save the macro into the designated folder.
<b>Cancel</b>	Close the Save Program dialogue box without saving a macro.
<b>New Folder</b>	Make a new folder.
<b>Delete</b>	Delete the specified file.
<b>Copy to FDD</b>	Copy the macro onto a floppy desk.
<b>Key board...</b>	Input filenames, etc. by using the mouse with the keyboard displayed on the screen.

### Loading macros

The following procedure can be used to load a saved macro.

- Step 1.** Display the Load Program dialogue box from the measurement screen of the E4991A by using the following menu command.

#### Utility - Load Program

- Step 2.** After inputting the filename of the macro and the name of the folder name to save it in, click the **OK** button to load the macro.

Each part of the Load Program dialogue box is explained as follows.

<b>Drive:</b>	Specify the folder to save the macro in.
<b>File Name:</b>	Input the filename of the macro.
<b>OK</b>	Load the macro.
<b>Cancel</b>	Close the Load Program dialogue box without loading a macro.
<b>New Folder</b>	Make a new folder.
<b>Delete</b>	Delete the specified file.
<b>Copy to FDD</b>	Copy the macro onto a floppy desk.
<b>Key board...</b>	Input filename, etc. by using the mouse with the keyboard displayed on the screen.

---

## Using E4991A VBA Help

If you don't know how to use a particular operation of E4991A VBA, you can find more on the topic in the E4991A VBA help (Visual Basic Reference).

### Displaying the E4991A VBA help screen

**Step 1.** The E4991A VBA help screen is displayed from Visual Basic Editor by using the following menu command.

#### Help - Microsoft Visual Basic Help

You can also display the E4991A VBA help screen by typing **[F1]** from the keyboard.

Figure 13-11

#### E4991A VBA help display screen

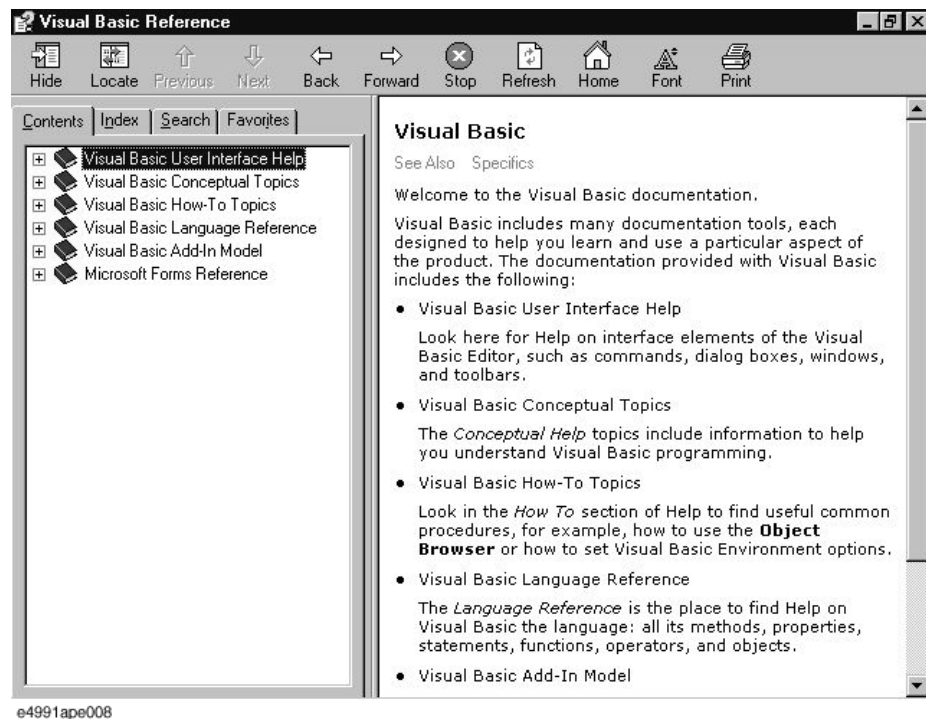

## Displaying topics of E4991A VBA

Each topic in E4991A VBA help is organized within a hierarchical structure. Double-click items to display their contents in the window pane to the right of the topic list. In addition, E4991A VBA has the following help tools.

- Visual Basic User Interface Help
- Visual Basic Conceptual Topics
- Visual Basic How-To Topics
- Visual Basic Add-In Model
- Microsoft Forms Reference

If you don't understand how to use Visual Basic Editor, you should initially refer to User Interface Help and How-To Topics.

## Referring to contents of keywords

A macro is prepared for the statement called keywords. For example, the words "Sub" and "With" are applied to such statements. If you don't understand how to a the keyword, move the cursor over the it while continuously holding the **[F1]** key on the keyboard. This will quickly display the E4991A VBA help related to the keyword. In addition, many keywords are displayed in blue within the Visual Basic Editor.





---

**14****Outline of Programming Using COM**

This chapter gives the required information for programming with the COM interface of the Agilent E4991A. For more basic information on the COM interface, refer to Chapter 18, “COM Interface Reference.”

## Outline of E4991A COM

COM is the abbreviation of “Component Object Model.” The following gives a simplified concept of COM and describes the COM interface specifications.

---

### NOTE

The company shall not guarantee the operation of the E4991A COM on any application software other than E4991A VBA (Visual Basic for Application).

### E4991A COM Object

The parts of the E4991A COM object interface are classified as follows.

#### Property

The object property is used for reading the status of the E4991A. For example, it is possible to confirm the version of E4991A VBA (Visual BASIC for Application) equipped with the E4991A instrument by using **VBAVersion property** on page 530.

This group includes COM objects indicated by the object name followed by “property.”

#### Method

With the E4991A, an object method is used for executing a target movement (operation) or realizing a function. For example, it is possible to execute a sweep once by using **SingleMeasure method** on page 532 or to copy the image of a measurement screen onto the clipboard after completing measurement by using **GetScreenImage method** on page 535.

This group includes COM objects indicated by the object name followed by “method.”

#### Event

You can confirm the status transitions that occur in the E4991A by detecting the events issued by the object. For example, you can determine the completion of a sweep by using **SweepEnd event** on page 537.

This group includes COM objects indicated by the object name followed by “event.”

## Limitations on using the E4991A COM object

When the E4991A cannot be controlled by only using a E4991A COM object, it is necessary to combine the following COM object methods with their corresponding E4991A GPIB commands.

- **Output method** on page 543
- **Enter method** on page 542
- **Query method** on page 543

## Comparison of COM objects and GPIB commands

The following table compares the E4991A's COM objects and GPIB commands

**Table 14-1** Function comparison of GPIB commands and COM objects

Item	Controls	GPIB command	COM object
Setting measurement conditions/read	Sets measurement conditions.	Dedicated GPIB commands are prepared.	No dedicated COM interface is prepared.
Preparing for accurate measurement (calibration/fixture compensation)	Sets conditions for calibration/fixture compensation and data measurement. Also switches on/off functions after data measurement.	Dedicated GPIB commands are prepared.	No dedicated COM interface is prepared.
	Measures calibration data/fixture compensation data.		Use the following COM interfaces.
	Detects the start/end of calibration data/fixture compensation measurement.	Use the GPIB Status report system.	<ul style="list-style-type: none"> <li>• <b>CalMeasure method</b> on page 533</li> <li>• <b>CompenMeasure method</b> on page 534</li> </ul>
Detecting the start of measurement (trigger) and completion of measurement (sweep completion)	Sets trigger to start measurement.	Dedicated GPIB commands are prepared.	No dedicated COM interface is prepared.
	Performs the sweep once.		Use the following COM interface.
	Waits for the end of sweep. (Detects the end of sweep.)	Use the GPIB Status report system.	<ul style="list-style-type: none"> <li>• <b>SingleMeasure method</b> on page 532</li> </ul>
	Confirms waiting status for the trigger.		Use the following COM interface. <ul style="list-style-type: none"> <li>• <b>WaitForEvent method</b> on page 536</li> </ul>
Reading/writing measurement data	Selects data transfer format.	Dedicated GPIB commands are prepared.	No dedicated COM interface is prepared.
	Reads/writes internal data array.		No dedicated COM interface is prepared. In <b>Enter method</b> on page 542, internal data array can be read by specifying how to read the data array.
Processing measurement result	Uses marker function and equivalent circuit analysis function.	Dedicated GPIB commands are prepared.	No dedicated COM interface is prepared.

**Table 14-1 Function comparison of GPIB commands and COM objects**

Saving/recalling files	Saves measurement parameter of E4991A, measurement results, etc. in files and recall saved contents.	Dedicated GPIB commands are prepared.	No dedicated COM interface is prepared.  When COM object is executed from a Personal Computer that uses remote user interface function, the folder at the Personal Computer side is used to save/recall the files.
Using printer	Outputs measurement results of E4991A to the printer.	Dedicated GPIB commands are prepared.	No dedicated COM interface is prepared.  When COM object is executed from a Personal Computer that uses remote user interface function, measurement results, etc. of E4991A are outputted to the printer registered at the Personal Computer side.
	Copies set parameters of E4991A, measurement results, etc. onto the clipboard.	Not prepared.	The following COM interfaces are prepared assuming usage of a Personal Computer that uses remote user interface function.  <ul style="list-style-type: none"> <li>• <b>GetTextData method</b> on page 535</li> <li>• <b>GetScreenImage method</b> on page 535</li> </ul>
Setting display screen	Sets the display screen.	Dedicated GPIB commands are prepared.	No dedicated COM interface is prepared.
Error processing	Reads errors.	Dedicated GPIB commands are prepared.	No dedicated COM interface is prepared.
	Detects an E4991A measurement failure and processes it.	Use the GPIB Status report system.	Use the following COM interfaces.  <ul style="list-style-type: none"> <li>• <b>Unlocked event</b> on page 539</li> <li>• <b>DcBiasOverload event</b> on page 539</li> <li>• <b>RfOverload event</b> on page 540</li> </ul>
	Detects an error other than the above type and processes it.		No dedicated COM interface is prepared.  By combined execution of COM object and GPIB command, status bit figures specified by each status register of GPIB Status report system can be read, but no processing can be performed during bit transition from 0 to 1 or 1 to 0.

**Table 14-1**                      **Function comparison of GPIB commands and COM objects**

Status report system	Checks the condition of the E4991A	Use the GPIB Status report system.	Use the GPIB Status report system as a rule. *1 Original COM objects are prepared to detect the following events. <ul style="list-style-type: none"> <li>• <b>SweepEnd event</b> on page 537</li> <li>• <b>SweepStart event</b> on page 538</li> <li>• <b>CompleteSweepAveraging event</b> on page 538</li> <li>• <b>Unlocked event</b> on page 539</li> <li>• <b>DcBiasOverload event</b> on page 539</li> <li>• <b>RfOverload event</b> on page 540</li> </ul>
System setting	Checks whether remote user interface function and E4991A are connected.	Not prepared.	The following COM interface is prepared assuming the usage of a Personal Computer that uses remote user interface function. <ul style="list-style-type: none"> <li>• <b>Connection property</b> on page 531</li> </ul>
	Items other than the above (system-related setting/reading)	Some dedicated GPIB commands are prepared.	No dedicated COM interface is prepared.

\*1. However, the SRQ is unavailable, so the procedure for setting the **\*SRE** on page 283 is always disabled. Furthermore, a program based on a COM interface cannot handle an interruption by using the SRQ.

---

## E4991A COM Object Model

The following objects are prepared for the E4991A.

Figure 14-1

### E4991A COM Object Model

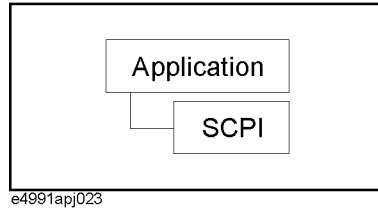

### Application Object

The application object is positioned at the top of the hierarchical structure of the E4991A COM object model.

#### Property

Name	Reads the application name “E4991A”.
VBAVersion	Reads the version of the E4991A VBA.
Connection	Reads whether it is connected with the E4991A by using the user interface function.

#### Method

SingleMeasure	Performs sweep and waits until completion.
CalMeasure	Measures calibration data and waits until completion.
CompenMeasure	Measures fixture compensation data and waits until completion.
GetTextData	Copies setting condition or measured data on the clipboard.
GetScreenImage	Copies screen image to the clipboard.
WaitForEvent	Waits for occurrence of specified event for specified period of time.

#### Event

SweepEnd	Indicates that the sweep was completed.
SweepStart	Indicates that the sweep has started.
CompleteSweepAveraging	Indicates the completion of the specified number of times of sweep averaging.
Unlocked	Indicates that “PLL Unlock” error was detected in the E4991A.
DcBiasOverLoad	Indicates that “DC bias overload” error was detected in the E4991A.
RfOverLoad	Indicates that “RF overload” error was detected in the E4991A.

## SCPI Object

SCPI objects are the group of objects prepared for combined use with the E4991A's GPIB commands.

### Property

Name Reads "SCPI".

### Method

Enter Reads returned value of GPIB command executed by Query.

Output Executes GPIB command.

Query Executes GPIB command by Query and reads the response.

## **E4991A Library**

The E4991A library is required when writing programs or executing them on the E4991A or on a personal computer with a remote user interface function using E4991A VBA. The E4991A library is pre-programmed for browsing through E4991A VBA.

### **Where to install the E4991A library**

The E4991A library is installed in the following location on a personal computer equipped with the E4991A remote user interface function.

Library name:	E4991A x.x Type Library
Location:	C:\Program File\Agilent\E4991A\E4991A.tlb



---

---

# 15

## Controlling Peripherals

This chapter explains how to control peripherals connected to the Agilent E4991A by using the software (VISA) installed in the instrument.

## Overview

The E4991A macro function (E4991A VBA) can be used not only to automate measurements but also to control external measurement instruments connected via GPIB cables by acting as a self-contained system controller (refer to “Remote control using E4991A macros” on page 32).

This function performs communications via the COM interface when controlling the E4991A itself, but it communicates via VISA (Virtual Instrument Software Architecture) when controlling external measurement instruments.

To control peripherals connected to the E4991A, the following two preparations are required.

### 1. Placing E4991A in system control mode

When the E4991A and its peripherals are controlled with the E4991A macro function, this is done via the GPIB bus inside the E4991A. Therefore, you need to set the GPIB system’s control mode to the system controller mode. Then you need to set the GPIB address as the system controller. Follow these steps using the front panel to place the E4991A in the system control mode.

**Step 1.** Place the E4991A in the system controller mode.

**System - GPIB Setup...** - Control Mode [System Controller]

**Step 2.** Set the GPIB address of the system controller.

**System - GPIB Setup...** - Controller Address [desired address number]

**Step 3.** Reboot the E4991A.

### 2. Importing definition files

To use the VISA library in the E4991A macro (E4991A VBA), you need to import two definition files into your project with the Visual Basic editor to define the VISA functions and perform other tasks. The definition files are stored on the sample programs disk under the following filenames (for information on importing modules, refer to “Importing modules” on page 224).

- visa32.bas
- vpptype.bas

## Programming with VISA

Figure 15-1 shows the flow of controlling the instrument with VISA. When developing a VISA program in the Visual Basic language, a special programming notice (in the readme text file listed below) must be reviewed.

For details on the use of the VISA library and the programming notice for using the VISA library with the E4991A macro (E4991A VBA), refer to the following files contained on the CD-ROM (Agilent part number: E4991-905x0).

- visa.hlp (on-line help for the VISA library)
- vbreadme.txt (notes on using the VISA library with VB)

Figure 15-1

Flow of instrument control with VISA

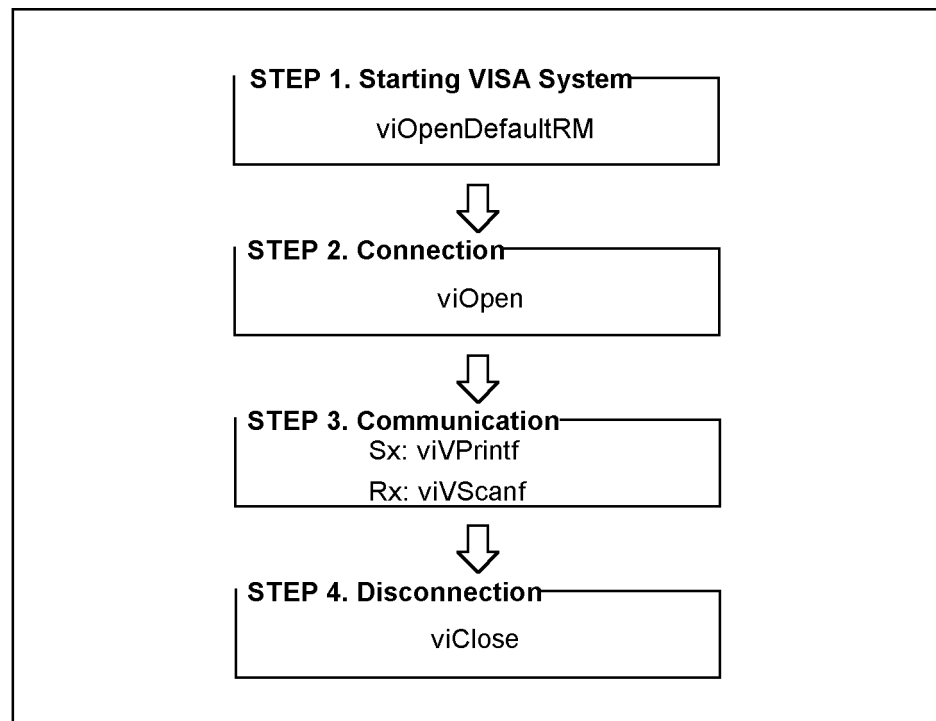

e4991ape033

## STEP 1. Starting up VISA system

The VISA system startup session is processed in Lines 150 to 160 in Example 15-1. VISA's viOpenDefaultRM function initializes and starts up the VISA system. The viOpenDefaultRM function must be executed before other VISA functions are called, and the parameter of this function is startup information (Defrm in Example 15-1).

### Syntax

viOpenDefaultRM(*param*)

### Parameter

	<i>(param)</i>
Description	Startup information (output)
Data type	Long integer type

## STEP 2. Connection

The connection session is handled in Lines 190 to 200 in Example 15-1. VISA's viOpen function makes connection with the specified instrument. The viOpen function returns a value so that the VISA functions can apply it to the specified instrument. The parameters of this function are startup information (Defrm in Example 15-1), the address information of the specified instrument ("GPIB0::5::INSTR" in Example 15-1), access mode (0 in Example 15-1), timeout (0 in Example 15-1), and connection information (Dcps in Example 15-1).

### Syntax

viOpen(*param1,param2,param3,param4,param5*)

### Parameters

	<i>(param1)</i>
Description	Startup information (input)
Data type	Long integer type

	<i>(param2)</i>
Description	Address information of the specified instrument (input)
Data type	Character string type
Syntax	GPIB[ <i>board</i> ] <sup>*1</sup> :: <i>primary address</i> <sup>*2</sup> ::INSTR

\*1. GPIB0 for the E4991A.

\*2. The GPIB address of the instrument controlled by the E4991A.

	<i>(param3)</i>
Description	Access mode (Enter 0)

	<i>(param4)</i>
Description	Timeout (Enter 0)

	<i>(param5)</i>
Description	Connection information (output)
Data type	Long integer type

### STEP 3. Communication

The communication session is conducted in Lines 230 to 280 and Line 410 in Example 15-1. VISA's viVPrintf function sends a program message (GPIB command) to the specified instrument. The parameters of this function are connection information (Dcps in Example 15-1), the program message (a GPIB command in Example 15-1), and the variable to be formatted (0 in Example 15-1).

---

#### NOTE

To input/output GPIB commands, the viVPrintf function and the viVScanf function are mainly used, but other VISA functions are also available. For more information, refer to visa.hlp (online help for the VISA library).

---

#### Syntax

viVPrintf(*param1,param2,param3*)

#### Parameters

	<i>(param1)</i>
Description	Connection information (input)
Data type	Long integer type

	<i>(param2)</i>
Description	Program message (input)*1
Data type	Character string type

\*1. When sending a program message of the GPIB command, a message terminator is required at the end of the message (Chr\$(10) in Example 15-1).

	<i>(param3)</i>
Description	A variable to be formatted*1
Data type	Specified data type

\*1. If not applicable, enter 0.

The receiving session is controlled in Lines 310 to 320 in Example 15-1. VISA's viVScanf function receives the result from the specified instrument and stores it in the output variable. The parameters of this function are connection information (Dcps in Example 15-1), the format parameter for the output variable (%t in Example 15-1), and the output

## Controlling Peripherals Programming with VISA

variable (Res in Example 15-1).

### Syntax

`viVScanf(param1,param2,param3)`

### Parameters

	<i>(param1)</i>
Description	Connection information (input)
Data type	Long integer type

	<i>(param2)</i>
Description	Format parameter for the output variable
Data type	Character string type

	<i>(param3)</i>
Description	Output variable (output)
Data type	Character string type

### STEP 4. Disconnection

The disconnection session is handled in Lines 190 to 200 in Example 15-1. VISA's `viClose` function disconnects communication and terminates the VISA system. The parameter of this function is startup information (Defrm in Example 15-1).

### Syntax

`viClose(param)`

### Parameter

	<i>(param)</i>
Description	Startup information (input)
Data type	Long integer type

## Application program using DC power supply (Agilent E3631A)

The sample program shown below controls the DC power supply (Agilent E3631A) connected via GPIB while using the E4991A as the system controller. This program is stored on the sample program disk. Its filename is ext\_cont.bas.

### NOTE

When controlling the DC power supply (Agilent E3631A) from the E4991A macro (E4991A VBA), VISA is used for communication of the GPIB commands supplied with the DC power supply (Agilent E3631A). On the other hand, when controlling the E4991A itself from the E4991A macro (E4991A VBA), the COM interface provided with the E4991A is used for communication (Lines 120 and 380 in Example 15-1).

Line 100	Assigns settings for the DC power supply output current to a variable.
Line 120	Sets the trigger source of the E4991A to the GPIB trigger via the COM interface.
Lines 150 to 160	Initializes and starts up the VISA system and outputs the startup information to the Defrm variable.
Lines 190 to 200	Establishes the connection to the DC power source (GPIB address: 5) and outputs the connection information to the Dcsp variable.
Lines 230 to 280	Via VISA, sets the DC power supply output current (0.1 A) and queries the output voltage value at that time.
Lines 310 to 350	Via VISA, reads out the DC power supply output voltage value and outputs it to the Res variable. Displays the read-out result in the message box.
Line 380	Via the COM interface, executes a single sweep to the E4991A and waits for the completion of the sweep.
Line 410	Via VISA, turns off the DC power supply output.
Line 440	Disconnects communication and terminates the VISA system.
Lines 480 to 520	If an error occurs in a VISA function, forces termination of the program.

### Example 15-1

#### Sample program using a DC power supply

```

10|
20| Sub main()
30|
40| Dim status As Long           'VISA function status return
code
50| Dim Defrm As Long           'Session to Default Resource
Manager
60| Dim Dcsp As Long            'Session to instrument
70| Dim Cur As Double           'Single to set current level
80| Dim Res As String * 100     'String to hold results
90|
100| Cur = 0.1
110|
120| SCPI.Output "TRIG:SOUR BUS"
130|
140| ' Initializes the VISA system.
150| status = viOpenDefaultRM(Defrm)
160| If (status <> VI_SUCCESS) Then GoTo VisaErrorHandler

```

## Controlling Peripherals

### Programming with VISA

```
170|
180|     ' Opens the session to the specified instrument.
190|     status = viOpen(Defrm, "GPIB0::5::INSTR", 0, 0, Dcsp)
200|     If (status <> VI_SUCCESS) Then GoTo VisaErrorHandler
210|
220|     ' Asks for the instrument to turn the dc power on.
230|     status = viVPrintf(Dcsp, "INST P6V" & Chr$(10), 0)
240|     status = viVPrintf(Dcsp, "VOLT MAX" & Chr$(10), 0)
250|     status = viVPrintf(Dcsp, "CURR %lf" & Chr$(10), Cur)
260|     status = viVPrintf(Dcsp, "OUTP ON" & Chr$(10), 0)
270|     status = viVPrintf(Dcsp, "MEAS?" & Chr$(10), 0)
280|     If (status <> VI_SUCCESS) Then GoTo VisaErrorHandler
290|
300|     ' Reads the result.
310|     status = viVScanf(Dcsp, "%t", Res)
320|     If (status <> VI_SUCCESS) Then GoTo VisaErrorHandler
330|
340|     ' Displays the result.
350|     MsgBox "Result is: " & Res
360|
370|     ' Performs a single measure.
380|     SingleMeasure
390|
400|     ' Turns the dc power off.
410|     status = viVPrintf(Dcsp, "OUTP OFF" & Chr$(10), 0)
420|
430|     ' Closes the resource manager session (which closes
everything)
440|     Call viClose(Defrm)
450|
460|     GoTo Prog_end
470|
480| VisaErrorHandler:
490|     Dim VisaErr As String * 200
500|     Call viStatusDesc(Defrm, status, VisaErr)
510|     MsgBox "Error : " & VisaErr, vbExclamation
520|     End
530|
540| Prog_end: End Sub
```



---

## 16 Application Programs

This chapter gives measurement examples (sample programs) using the HTBasic program and the instrument's macro program (E4991A VBA).

## Basic Measurement

This application program performs a measurement similar to that of the “Basic operation of RF device measurement” in the E4991A *Installation and Quick Start Guide*.

### HTBasic example program

Example 16-1 shows a basic measurement program example (HTBasic) to find the self-resonance point of an inductor. This program is saved under the file name `bsc_meas.htb` on the sample programs disk. When the program is executed, “Do all the preparations for a measurement.” is displayed. Then connect the equipment in accordance with Chapter 3 “Step 1, Preparations for measurement” in the Installation/Quick Start Guide and start measurement by pushing the **[y]** key or the **[Enter]** key.

When the calibration function is set on, “Do you perform a calibration again?” is displayed. Push any key other than the **[y]** key or the **[Enter]** key to skip calibration. Next, “Connect OPEN Standard to the DUT port.” will be displayed. Then, after connecting the OPEN standard, push the **[y]** key or the **[Enter]** key and measure the open calibration data. In the same way, measure Short/Load/Low-loss capacitor calibration data. However, low-loss capacitor calibration should only be performed as necessary.

Next, “Connect the FXT16197A text fixture to the E4991A” is displayed, and after connecting the 16197A, push the **[y]** key or the **[Enter]** key. Then, “Connect OPEN Standard to electrode plate on the fixture.” is displayed, and after opening the test fixture sample connection screen, push the **[y]** key or the **[Enter]** key to measure open compensation data. In the same way, measure short compensation data.

Next, “Connect the DUT to electrode plate on the fixture.” is displayed. After connecting the chip inductor to the text fixture, pushing the **[y]** key or the **[Enter]** key will execute one sweep, and the marker will search for a self-resonance point; as a result, the frequency and impedance of that point will be displayed. After the measurement result is indicated, “Performing a measurement again? [Y/N]” is displayed. When measuring again or measuring another sample of the same size, push the **[y]** key or the **[Enter]** key to continue the measurement. To finish measurement, push any key other than the **[y]** or the **[Enter]** key.

Line 220	Sets the GPIB address
Lines 240 - 280	Substitutes a variable for the sweep condition. Sets the number of points (201), sweep parameter (frequency sweep type is logarithmic), sweep start value (1 MHz), sweep stop value (3 GHz), and electric current level of the source (1 mA).
Lines 290 - 350	Substitutes variables for the measurement parameter and display method. Sets the parameters for trace 1 ( $ Z $ ), trace 2 (Ls), and trace 3 (Q), the display formats for trace 1 (log), trace 2 (linear), and trace 3 (linear), and the display method (displays all traces superimposed in one window).
Lines 360 - 380	Substitutes variables for the setting conditions for calibration and fixture compensation, as well as for the marker function. Sets the calibration/fixture compensation data measurement point (fixed frequency point/fixed power point), test fixture used (16197A), and marker search function (to detect the maximum value).
Lines 400 - 410	Prompts preparation for measurement and waits for input of the <b>[y]</b>

	key after completion of preparation. If any other key is input, the program is aborted. The subprogram FNMessage is explained later.
Lines 490 - 510	Returns the E4991A to the default status.
Lines 550 - 610	Sets the sweep conditions. In addition, sets the trigger source to the GPIB trigger.
Lines 650 - 740	Display traces 1, 2, and 3, and sets the measurement parameter and display format for each trace. In addition, the three traces are superimposed and displayed in one window.
Lines 800 - 850	Confirms that the calibration function is set on and, if it is set on, prompts whether to carry out another calibration. If any key other than the [y] key is input, the calibration is skipped.
Lines 890 - 900	Sets the calibration kit to the attached 7-mm calibration kit and sets the calibration data measurement point to the fixed frequency point/fixed power point.
Lines 940 - 1010	Measures open/short/load calibration data. Refer to “Example program for execution of calibration” on page 78 for details on the subprogram FNCal.
Lines 1030 - 1070	Waits for the input on whether to execute low-loss capacitor calibration. If the [y] key is entered, low-loss capacitor calibration data is measured. If any other key is entered, low-loss capacitor calibration is skipped.
Lines 1090 - 1130	A calibration coefficient is calculated based on the calibration data obtained, and calibration is enabled.
Lines 1220 - 1260	Prompts the connection of the 16197A test fixture and waits for input of the [y] key after connection. If any other key is entered, the program is aborted. Next, sets the test fixture to be used to the 16197A.
Line 1340	Sets the fixture compensation data measurement point to the fixed frequency point/fixed power point.
Lines 1380 - 1420	Measures the open/short compensation data. Refer to “Example program for execution of fixture compensation” on page 97 for details on the subprogram FNFixt_comp.
Lines 1440 - 1480	Calculates the compensation coefficient based on the fixture compensation data obtained, and fixture compensation is enabled.
Lines 1550 - 1560	Prompts connection of the sample to the electrode of the test fixture and waits for input of the [y] key after connection. If any other key is entered, the program is aborted.
Lines 1640	Clears the status byte register and the operation status event register.
Lines 1650 - 1660	If the operation status condition register bit 4 transits from 1 to 0 (negative transit), the operation status event register bit 4 is set to 1.
Lines 1670 - 1680	Sets the operation status event register bit 4 and the status byte register bit 7 to be enabled.
Lines 1690 - 1700	Sets the branch on which the SRQ interrupts and sets the SRQ interruption to be enabled.
Lines 1720 - 1750	Triggers and executes a sweep once and then waits for completion of the sweep.

## Application Programs

### Basic Measurement

- Line 1760 Cancels the event start branch of the SRQ interruption.
- Lines 1810 - 1830 Executes the auto-scale adjustment for traces 1, 2, and 3, and sets it to the optimum scale.
- Lines 1870 - 1900 Sets On marker 1 for trace 1. After specifying marker 1 as an active marker, searches for the maximum value (self-resonance point) using the marker search function.
- Lines 1940 - 1970 Reads out the stimulus value (frequency) and the measurement value (impedance) for trace 1.
- Lines 2010 - 2040 Shows the read-out measurement results on the display.
- Lines 2060 - 2100 Prompts input on whether a measurement will be performed again or whether another sample of the same size will be measured. If the **[y]** key is input, returns to the sample connection part. If any other key is entered, the program is terminated.
- Lines 2180 - 2640 Refer to “Example program for execution of calibration” on page 78 for details on the subprogram FNCal.
- Lines 2670 - 3080 Refer to “Example program for execution of fixture compensation” on page 97 for details on the subprogram FNFixt\_comp.
- Lines 3120 - 3240 Displays the message specified by the variable Mes\$ and waits for the input of **[y]** or **[n]**. If the **[y]** key is entered, the return value of the function program is returned as 0. If the **[n]** key is entered, the return value of the function program is returned as -1. If any other key than these is pushed, the program returns to the first input line.

Example 16-1

Measuring the self-resonant point of an inductor

```

10
!*****
20  !* E4991A + 16197A Impedance Measurement (Using Chip Inductor)
30  !* HTBasic Sample Program
40
!*****
50  !
60
!#####
70  ! STEP1: Preparation for a Measurement
80
!#####
90  !
100 DIM Inp_char$(9),Buff$(9)
110 DIM Swp_type$(11)
120 DIM Para_a$(5),Para_b$(5),Para_c$(5)
130 DIM Fmt_a$(11),Fmt_b$(11),Fmt_c$(11),Display$(11)
140 DIM Cal_type$(11),Fixture$(11)
150 DIM Mkr_src$(9)
160 REAL Curr_lev,Start,Stop
170 REAL Freq_val,Imp_val
180 INTEGER Corr,Nop,Reply,Result
190 !
200 CLEAR SCREEN
210 !
220 ASSIGN @Agte4991a TO 717
230 !
240 Nop=201 ! Number of Points: 201
250 Swp_type$="LOG" ! Type of Sweep Mode(X-axis):
LOGARITHMIC
260 Start=1.0E+6 ! Start Frequency: 1.0 MHz
270 Stop=3.0E+9 ! Stop Frequency: 3.0 GHz
280 Curr_lev=1.0E-3 ! Source Current Level: 1 mA
290 Para_a$="Z" ! Measurement/ Trace1: |Z|
300 Para_b$="LS" ! Parameters Trace2: Ls
310 Para_c$="Q" ! Trace3: Q
320 Fmt_a$="LOG" ! Display/ Trace1: LOGARITHMIC
330 Fmt_b$="LIN" ! Format(Y-axis) Trace2: LINEAR
340 Fmt_c$="LIN" ! Trace3: LINEAR
350 Display$="OVER" ! Display Split/Overlay: OVERLAY
360 Cal_type$="FIX" ! Calibration Type: FIXED
370 Fixture$="FXT16197A" ! Test Fixture: 16197A
380 Mkr_src$="MAX" ! Specified Search Function: MAXIMUM
390 !
400 Reply=FNMessage(@Agte4991a,"Do all the preparations for a
measurement.")
410 IF Reply<>0 THEN Prog_int
420 !
430
!#####
440 ! STEP2: Specifying Measurement Conditions
450
!#####
460 !
470 ! -> Reset the E4991A to default state

```

## Application Programs

### Basic Measurement

```
480 !
490 OUTPUT @Agte4991a;"SYST:PRES"
500 OUTPUT @Agte4991a;"*OPC?"
510 ENTER @Agte4991a;Buff$
520 !
530 ! -> Specifying Sweep Conditions
540 !
550 OUTPUT @Agte4991a;"SWE:POIN ";Nop
560 OUTPUT @Agte4991a;"SWE:TYPE "&Swp_type$
570 OUTPUT @Agte4991a;"FREQ:STAR ";Start
580 OUTPUT @Agte4991a;"FREQ:STOP ";Stop
590 OUTPUT @Agte4991a;"SOUR:CURR:MODE FIX"
600 OUTPUT @Agte4991a;"SOUR:CURR ";Curr_lev
610 OUTPUT @Agte4991a;"TRIG:SOUR BUS"
620 !
630 ! -> Specifying Measurement Parameters
640 !
650 OUTPUT @Agte4991a;"DISP:TRAC1 ON"
660 OUTPUT @Agte4991a;"DISP:TRAC2 ON"
670 OUTPUT @Agte4991a;"DISP:TRAC3 ON"
680 OUTPUT @Agte4991a;"CALC1:FORM "&Para_a$
690 OUTPUT @Agte4991a;"CALC2:FORM "&Para_b$
700 OUTPUT @Agte4991a;"CALC3:FORM "&Para_c$
710 OUTPUT @Agte4991a;"DISP:TRAC1:Y:SPAC "&Fmt_a$
720 OUTPUT @Agte4991a;"DISP:TRAC2:Y:SPAC "&Fmt_b$
730 OUTPUT @Agte4991a;"DISP:TRAC3:Y:SPAC "&Fmt_c$
740 OUTPUT @Agte4991a;"DISP:FORM "&Display$
750 !
760
#####
770 ! STEP3: Calibration (FIXED)
780
#####
790 !
800 OUTPUT @Agte4991a;"SENS:CORR1?"
810 ENTER @Agte4991a;Corr
820 IF Corr=1 THEN
830     Reply=FNMessage(@Agte4991a,"Do you perform a calibration
again?")
840     IF Reply<>0 THEN Cal_skip
850 END IF
860 !
870 ! -> Initial Settings
880 !
890 OUTPUT @Agte4991a;"SENS:CORR1:CKIT DEF"
900 OUTPUT @Agte4991a;"SENS:CORR1:COLL:FPO "&Cal_type$
910 !
920 ! -> Data Measurement
930 !
940 Result=FNCal(@Agte4991a,"OPEN")
950 IF Result<>0 THEN Prog_int
960 !
970 Result=FNCal(@Agte4991a,"SHORT")
980 IF Result<>0 THEN Prog_int
990 !
1000 Result=FNCal(@Agte4991a,"LOAD")
1010 IF Result<>0 THEN Prog_int
1020 !
```

```

1030 Reply=FNMessage(@Agte4991a,"Do you want to measure a LOW-LOSS
CAPACITOR?")
1040 IF Reply=0 THEN
1050     Result=FNCal(@Agte4991a,"LOW-LOSS C")
1060     IF Result<>0 THEN Prog_int
1070 END IF
1080 !
1090 OUTPUT @Agte4991a;"SENS:CORR1:COLL:SAVE"
1100 OUTPUT @Agte4991a;"*OPC?"
1110 ENTER @Agte4991a;Buff$
1120 PRINT "All cal-data measurement completion"
1130 PRINT
1140 !
1150 Cal_skip: !
1160 !
1170
#####
1180 ! STEP4: Connect the Test Fixture
1190 ! STEP5: Setting the Electrical Length of the Test Fixture
1200
#####
1210 !
1220 Reply=FNMessage(@Agte4991a,"Connect the "&Fixture$&" test
fixture to the E4991A.")
1230 IF Reply<>0 THEN Prog_int
1240 OUTPUT @Agte4991a;"SENS:CORR2:FIXT "&Fixture$
1250 OUTPUT @Agte4991a;"*OPC?"
1260 ENTER @Agte4991a;Buff$
1270 !
1280
#####
1290 ! STEP6: Compensation (FIXED)
1300
#####
1310 !
1320 ! -> Initial Settings
1330 !
1340 OUTPUT @Agte4991a;"SENS:CORR2:COLL:FPO "&Cal_type$
1350 !
1360 ! -> Data Measurement
1370 !
1380 Result=FNFixt_comp(@Agte4991a,"OPEN")
1390 IF Result<>0 THEN Prog_int
1400 !
1410 Result=FNFixt_comp(@Agte4991a,"SHORT")
1420 IF Result<>0 THEN Prog_int
1430 !
1440 OUTPUT @Agte4991a;"SENS:CORR2:COLL:SAVE"
1450 OUTPUT @Agte4991a;"*OPC?"
1460 ENTER @Agte4991a;Buff$
1470 PRINT "All compen-data measurement completion"
1480 PRINT
1490 !
1500
#####
1510 ! STEP7: Connect the DUT (Chip Inductor)
1520
#####

```

## Application Programs

### Basic Measurement

```
1530 !
1540 Meas_start: !
1550 Reply=FNMessage(@Agte4991a,"Connect the DUT to electrode plate
on the fixture.")
1560 IF Reply<>0 THEN Prog_int
1570 !
1580
#####
1590 ! STEP:8 Auto Scaling & Maximum Point Search
1600
#####
1610 !
1620 ! -> Performing a Single Sweep
1630 !
1640 OUTPUT @Agte4991a;"*CLS"
1650 OUTPUT @Agte4991a;"STAT:OPER:PTR 0"
1660 OUTPUT @Agte4991a;"STAT:OPER:NTR 16"
1670 OUTPUT @Agte4991a;"STAT:OPER:ENAB 16"
1680 OUTPUT @Agte4991a;"*SRE 128"
1690 ON INTR 7 GOTO Auto_scaling
1700 ENABLE INTR 7;2
1710 !
1720 OUTPUT @Agte4991a;"TRIG"
1730 DISP "Now sweeping...."
1740 Meas_wait: GOTO Meas_wait
1750 Meas_end: DISP
1760 OFF INTR 7
1770 !
1780 ! -> Performing an Auto-scale
1790 !
1800 Auto_scaling: !
1810 OUTPUT @Agte4991a;"DISP:TRAC1:Y:AUTO"
1820 OUTPUT @Agte4991a;"DISP:TRAC2:Y:AUTO"
1830 OUTPUT @Agte4991a;"DISP:TRAC3:Y:AUTO"
1840 !
1850 ! -> Searching the Maximum value
1860 !
1870 OUTPUT @Agte4991a;"CALC1:MARK1 ON"
1880 OUTPUT @Agte4991a;"CALC1:MARK1:ACT"
1890 OUTPUT @Agte4991a;"CALC1:MARK:FUNC "&Mkr_src$
1900 OUTPUT @Agte4991a;"CALC1:MARK:FUNC:EXEC"
1910 !
1920 ! -> Reading a marker's value
1930 !
1940 OUTPUT @Agte4991a;"CALC1:MARK1:X?"
1950 ENTER @Agte4991a;Freq_val
1960 OUTPUT @Agte4991a;"CALC1:MARK1:Y?"
1970 ENTER @Agte4991a;Imp_val
1980 !
1990 ! -> Displaying Measurement Result
2000 !
2010 PRINT " -----Measurement Result-----"
2020 PRINT USING "13A,6D.6D,6A";" Frequency: ",Freq_val/1.0E+6,"
[MHz]"
2030 PRINT USING "13A,6D.6D,6A";" Impedance: ",Imp_val," [ohm]"
2040 PRINT ""
2050 !
2060 Reply=FNMessage(@Agte4991a,"Performing a measurement again?")
```



```
2070 IF Reply=0 THEN Meas_start
2080 PRINT
2090 PRINT "Program ended!"
2100 GOTO Prog_end
2110 !
2120 Prog_int: !
2130 PRINT "Program interruption"
2140 !
2150 Prog_end: END
2160 !
2170 !
2180 DEF FNCal(@Agte4991a,Standard$)
2190     DIM Inp_char$(9),Err_mes$(50)
2200     INTEGER Err_no
2210     !
2220     Inp_char$="Y"
2230     !
2240     PRINT "Connect "&Standard$&" standard to the DUT port."
2250 Inp_start: !
2260     INPUT "OK? [Y/N]",Inp_char$
2270     IF UPC$(Inp_char$)="Y" THEN
2280         OUTPUT @Agte4991a;"*CLS"
2290         OUTPUT @Agte4991a;"STAT:OPER:PTR 0"
2300         OUTPUT @Agte4991a;"STAT:OPER:NTR 1"
2310         OUTPUT @Agte4991a;"STAT:OPER:ENAB 1"
2320         OUTPUT @Agte4991a;"*SRE 128"
2330         ON INTR 7 GOTO Meas_end
2340         ENABLE INTR 7;2
2350         SELECT Standard$
2360         CASE "OPEN"
2370             OUTPUT @Agte4991a;"SENS:CORR1:COLL STAN1"
2380         CASE "SHORT"
2390             OUTPUT @Agte4991a;"SENS:CORR1:COLL STAN2"
2400         CASE "LOAD"
2410             OUTPUT @Agte4991a;"SENS:CORR1:COLL STAN3"
2420         CASE "LOW-LOSS C"
2430             OUTPUT @Agte4991a;"SENS:CORR1:COLL STAN4"
2440         END SELECT
2450         DISP "Now measuring..."
2460 Meas_wait: GOTO Meas_wait
2470 Meas_end: DISP
2480         OFF INTR 7
2490         OUTPUT @Agte4991a;"SYST:ERR?"
2500         ENTER @Agte4991a;Err_no,Err_mes$
2510         IF Err_no=0 THEN
2520             PRINT Standard$&" data measurement completion"
2530             PRINT
2540             RETURN 0
2550         ELSE
2560             PRINT "Error: "&Err_mes$
2570             PRINT
2580             RETURN -1
2590         END IF
2600     ELSE
2610         PRINT
2620         RETURN -1
2630     END IF
2640 FNEND
```

## Application Programs

### Basic Measurement

```
2650 !
2660 !
2670 DEF FNFixt_comp(@Agte4991a,Standard$)
2680   DIM Inp_char$(9),Err_mes$(50)
2690   INTEGER Err_no
2700   !
2710   Inp_char$="Y"
2720   !
2730   PRINT "Connect "&Standard$&" standard to electrode plate on
the fixture."
2740   INPUT "OK? [Y/N]",Inp_char$
2750   IF UPC$(Inp_char$)="Y" THEN
2760     OUTPUT @Agte4991a;"*CLS"
2770     OUTPUT @Agte4991a;"STAT:OPER:PTR 0"
2780     OUTPUT @Agte4991a;"STAT:OPER:NTR 128"
2790     OUTPUT @Agte4991a;"STAT:OPER:ENAB 128"
2800     OUTPUT @Agte4991a;"*SRE 128"
2810     ON INTR 7 GOTO Meas_end
2820     ENABLE INTR 7;2
2830     SELECT Standard$
2840     CASE "OPEN"
2850       OUTPUT @Agte4991a;"SENS:CORR2:COLL STAN1"
2860     CASE "SHORT"
2870       OUTPUT @Agte4991a;"SENS:CORR2:COLL STAN2"
2880     END SELECT
2890     DISP "Now measuring..."
2900 Meas_wait: GOTO Meas_wait
2910 Meas_end: DISP
2920   OFF INTR 7
2930   OUTPUT @Agte4991a;"SYST:ERR?"
2940   ENTER @Agte4991a;Err_no,Err_mes$
2950   IF Err_no=0 THEN
2960     PRINT Standard$&" data measurement completion"
2970     PRINT
2980     RETURN 0
2990   ELSE
3000     PRINT "Error: "&Err_mes$
3010     PRINT
3020     RETURN -1
3030   END IF
3040   ELSE
3050     PRINT
3060     RETURN -1
3070   END IF
3080 FNEND
3090 !
3100 DEF FNMessage(@Agte4991a,Mes$)
3110   DIM Inp_char$(9)
3120   PRINT Mes$
3130   PRINT
3140 Inp_start: !
3150   INPUT "Ready? [Y/N]",Inp_char$
3160   SELECT UPC$(Inp_char$)
3170   CASE "Y"
3180     RETURN 0
3190   CASE "N"
3200     RETURN -1
3210   CASE ELSE
```

```
3220          GOTO Inp_start  
3230      END SELECT  
3240  FNEND
```

### Macro (E4991A VBA) Example Program

Example 16-2 and Example 16-3 show how a basic measuring program (E4991A VBA) finds the self-resonance point of the inductor. The specifications for this application program are in accordance with the aforementioned “HTBasic example program” on page 254. This program is saved under the filenames bsc\_meas.lcr (macro program). The structure and functions of the program are shown as follows.

---

**NOTE** For more on loading macros, see “Loading macros” on page 233.

---

Filename	Type of module	Object name	Function
bsc_meas.bas	module	bsc_meas	Procedure for basic measurement
bsc_meas.cls	class module	clsErr	Event to end the program when measurement failure occurs in the analyzer.

In the main procedure (bsc\_meas.bas in this example), when an event created in another module (bsc\_meas.cls in this example) is used, the event variable is defined as the Public type in the class module (line 20 in Example 16-3) and the object variable is stated and set as follows in the main module (lines 50 - 60 in Example 16-2). Then the object variable is disassociated from an actual object (line 1870 in Example 16-2).

**Setting object variables**

- Dim *variable* As New *Class name to be used*
- Set *object variable* As New *Library name to be used*

**Disassociating object variables**

- Set *object variable* = Nothing

---

**NOTE** End statement (lines 70, 140 and 210 in Example 16-3) is also used for disassociating object variables.

---

<i>Variable</i> .....	The user can specify any variable.
<i>Class name to be used</i> .....	Class name (clsErr in this example) specified in Name property in the class module. The user can specify any class name.
<i>Object variable</i> .....	Object variable property is defined by the user.
<i>Library name to be used</i> .....	E4991A library (E4991ALib.Application)

---

**NOTE** When using an application other than the E4991A VBA, it is necessary to execute the setting so that the E4991A library can be referred to and to activate the remote user interface function before creating/executing the program. See “E4991A Library” on page 244 and Chapter 10 “Using Remote User Interface” in the *E4991A Operation Manual* for details.

---



---

**NOTE** In order to execute a macro from the measurement screen of the E4991A without using the Visual Basic editor, it is necessary to define the procedure as a Public type (line 20 of

Example 16-2) in the module only. For more on the execution of macros, see “Executing macros” on page 230.

The details of the program (bsc\_meas/bas) are explained below. The line numbers are added for the sake of explanation but are usually not displayed.

- Lines 50 - 60 Defines the variable (Err) to use the event created in the class module (class name: clsErr). Next, sets the object variable (Err.Evnt) to the E4991A library.
- Lines 200 - 240 Substitutes variables for the sweep condition. Sets the number of points (201), sweep parameter (frequency sweep type is logarithmic), sweep start value (1 MHz), sweep stop value (3 GHz) and electric current level of the source (1 mA).
- Lines 250 - 320 Substitutes variables for the measurement parameter and display method. Sets the parameters for trace 1 ( $|Z|$ ), trace 2 (Ls), and trace 3 (Q), the display formats for trace 1 (log), trace 2 (linear), and trace 3 (linear), the number of sweep-to-sweep averaging (three times), and the display method (displays all traces superimposed in one window).
- Lines 330 - 350 Substitutes variables for the setting conditions for calibration, fixture compensation, and marker function. Sets calibration/fixture compensation data measurement point (fixed frequency point/fixed power point), test fixture used (16197A), and marker search function (to detect the maximum value).
- Lines 370 - 380 Prompts preparation for measurement and waits for the **Yes** button to be clicked after the completion of preparation. Clicking the **No** button will abort the program. The subprogram Message is explained below.
- Lines 440 - 450 Returns the E4991A to default status.
- Lines 490 - 550 Sets the sweep conditions. In addition, sets the trigger source to the GPIB trigger.
- Lines 590 - 670 Displays traces 1, 2, and 3 and sets the measurement parameter and display format for each trace.
- Lines 680 - 700 Sets on the sweep-to-sweep averaging function (number of averaging: 3). In addition, superimposes and displays the three traces in one window.
- Lines 740 - 790 Checks if the calibration function is on and, if it is on, prompts input on whether to execute calibration again. Click the **Yes** button to execute calibration again, or click the **No** button to skip calibration.
- Lines 830 - 840 Sets the calibration kit to the attached 7-mm calibration kit and sets the calibration data measurement point to the fixed frequency point/fixed power point.
- Lines 880 - 950 Measures open/short/load calibration data. Furthermore, the subprogram Cal will be explained later.
- Lines 970 - 1010 Prompts input on whether to execute low-loss capacitor calibration. Click the **Yes** button to measure the low-loss capacitor calibration data, or click the **No** button to skip low-loss capacitor calibration.
- Lines 1030 - 1050 Calculates the calibration coefficient based on the calibration data obtained and enables calibration.

## Application Programs

### Basic Measurement

- Lines 1120 - 1150 Prompts the connection of the 1619A text fixture and waits for the **Yes** button to be clicked after the connection. Click the **No** Button to abort the program. Next, sets the test fixture to be used to the 16197A.
- Line 1210 Sets the fixture compensation data to fixed frequency point/ fixed power point.
- Lines 1250 - 1290 Measures the open/short compensation data. The subprogram Fixt\_comp is explained below.
- Lines 1310 - 1330 Calculates the compensation coefficient based on the fixture compensation data obtained and enables fixture compensation.
- Lines 1380 - 1390 Prompts connection of the sample to the electrode of the text fixture and waits for the **Yes** button to be clicked after the connection. Click the **No** button to abort the program.
- Lines 1450 - 1500 Resets the sweep-to-sweep averaging, executes one sweep for the number of averaging, and then waits for completion of the sweep. If any error occurs during the sweep, the program is aborted.
- Lines 1550 - 1570 Performs the auto-scale adjustment for traces 1, 2, and 3 and sets them to the optimum scale.
- Lines 1610 - 1640 Sets on marker 1 for trace 1. After specifying marker 1 as the active marker, searches for the maximum value (self-resonance value) using the marker search feature.
- Lines 1680 - 1710 Reads out the stimulus value (frequency) for marker 1 as well as the measured value (absolute value of the impedance) for trace 1.
- Lines 1750 - 1800 Displays the read-out measurement results in the message box. Prompts input on whether to perform measurement again or whether to measure another sample of the same size. Click the **Yes** button to return to the connection part of the sample, or click the **No** button to end the program.
- Line 1870 Disassociates the object variable used for the event function.

Below is an explanation of the function program Cal for measuring the calibration data.

- Line 1960 Prompts the connection of the standard for the calibration specified by the variable Standard and waits for the **Yes** button to be clicked after the connection.
- Lines 1990 - 2080 Measures the standard calibration data specified by the variable Standard and waits for the completion of measurement.
- Lines 2090 - 2140 If measurement of the calibration data is not completed because of some kind of error, displays a message indicating interruption of measurement and returns the function program return value as -1. When measurement of the calibration data is completed, returns the function program return value as 0.

Below is an explanation of the function program Fixt\_comp for measuring the fixture compensation data.

- Line 2260 Prompts the connection of the standard for the fixture compensation specified by the variable Standard and waits for the **Yes** button to be clicked after the connection.
- Lines 2290 - 2340 Measures the standard fixture compensation data specified by the

variable Standard and waits for the completion of measurement.

Lines 2350 - 2400 If measurement of the fixture compensation data is not completed because of some kind of error, displays a message indicating interruption of measurement and returns the function program return value as -1. When measurement of the fixture compensation data is completed, returns the function program return value as 0.

Below is an explanation of the function program Message for displaying messages.

Lines 2510 - 2570 Displays a message specified by the variable Mes and waits for either the **Yes** button or the **No** button to be clicked. When the **Yes** button is clicked, returns the function program return value as 0; when the **No** button is clicked, returns the function program return value as -1.

### Example 16-2

#### Measuring the self-resonant point of an inductor (bsc\_meas.bas)

```

10|
20|     Sub Main()
30|         ' Preparation for Using Event Procedure
40|
50|         Dim Err As New clsErr
60|         Set Err.Evnt = New E4991ALib.Application
70|
80|         ' STEP1: Preparation for a Measurement
90|
100|        Dim buff As String
110|        Dim Swp_type As String
120|        Dim Para_a As String, Para_b As String, Para_c As String
130|        Dim Fmt_a As String, Fmt_b As String, Fmt_c As String,
Display As String
140|        Dim Cal_type As String, Fixture As String, Mkr_src As
String
150|        Dim Curr_lev As Double, Swp_start As Double, Swp_stop
As Double
160|        Dim Freq_val As Double, Imp_val As Double
170|        Dim swp_count As Integer, Corr As Integer, i As Integer,
nop As Integer, Reply As Integer, Result As Integer
180|        Dim Answer As Long
190|
200|        nop = 201           '           Number of Points: 201
210|        Swp_type = "LOG"   '           Sweep Type(X-axis):
LOGARITHMIC
220|        Swp_start = 1000000# '           Start Frequency: 1.0
MHz
230|        Swp_stop = 3000000000# '           Stop Frequency: 3.0
GHz
240|        Curr_lev = 0.001   '           Source Current Level: 1 mA
250|        Para_a = "Z"       '           Measurement/      Trace1: |Z|
260|        Para_b = "LS"     '           Parameters      Trace2: Ls
270|        Para_c = "Q"       '           Trace3: Q
280|        Fmt_a = "LOG"     '           Display/          Trace1:
LOGARITHMIC
290|        Fmt_b = "LIN"     '           Format(Y-axis) Trace2:
LINEAR
300|        Fmt_c = "LIN"     '           Trace3: LINEAR
310|        swp_count = 3     '           Sweep Averaging Count: 3
320|        Display = "OVER"  '           Display Split/Overlay:
OVERLAY

```

## Application Programs

### Basic Measurement

```
330|         Cal_type = "FIX"           '           Calibration Type: FIXED
340|         Fixture = "FXT16197A"     '           Test Fixture:
16197A
350|         Mkr_src = "MAX"           ' Specified Search Function:
MAXIMUM
360|
370|         Reply = Message("All the preparations for a measurement
are complete?")
380|         If Reply <> 0 Then GoTo Prog_int
390|
400|         ' STEP2: Specifying Measurement Conditions
410|
420|         '   Reset the E4991A to the Default State
430|
440|         SCPI.Output "SYST:PRES"
450|         buff = SCPI.Query("*OPC?")
460|
470|         '   Specifying Sweep Conditions
480|
490|         SCPI.Output "SWE:POIN " & CStr(nop)
500|         SCPI.Output "SWE:TYPE " & Swp_type
510|         SCPI.Output "FREQ:STAR " & CStr(Swp_start)
520|         SCPI.Output "FREQ:STOP " & CStr(Swp_stop)
530|         SCPI.Output "SOUR:CURR:MODE FIX"
540|         SCPI.Output "SOUR:CURR " & CStr(Curr_lev)
550|         SCPI.Output "TRIG:SOUR BUS"
560|
570|         '   Specifying Measurement Parameters
580|
590|         SCPI.Output "DISP:TRAC1 ON"
600|         SCPI.Output "DISP:TRAC2 ON"
610|         SCPI.Output "DISP:TRAC3 ON"
620|         SCPI.Output "CALC1:FORM " & Para_a
630|         SCPI.Output "CALC2:FORM " & Para_b
640|         SCPI.Output "CALC3:FORM " & Para_c
650|         SCPI.Output "DISP:TRAC1:Y:SPAC " & Fmt_a
660|         SCPI.Output "DISP:TRAC2:Y:SPAC " & Fmt_b
670|         SCPI.Output "DISP:TRAC3:Y:SPAC " & Fmt_c
680|         SCPI.Output "CALC:AVER:COUN " & CStr(swp_count)
690|         SCPI.Output "CALC:AVER ON"
700|         SCPI.Output "DISP:FORM " & Display
710|
720|         ' STEP3: Calibration
730|
740|         SCPI.Output "SENS:CORR1?"
750|         SCPI.Enter Corr
760|         If Corr = 1 Then
770|             Reply = Message("Do you perform a calibration?")
780|             If Reply <> 0 Then GoTo Cal_skip
790|         End If
800|
810|         '   Initial Settings
820|
830|         SCPI.Output "SENS:CORR1:CKIT DEF"
840|         SCPI.Output "SENS:CORR1:COLL:FPO " & Cal_type
850|
860|         '   Data Measurement
870|
```



```
880|         Result = Cal("OPEN")
890|         If Result <> 0 Then GoTo Prog_int
900|
910|         Result = Cal("SHORT")
920|         If Result <> 0 Then GoTo Prog_int
930|
940|         Result = Cal("LOAD")
950|         If Result <> 0 Then GoTo Prog_int
960|
970|         Reply = Message("Do you want to measure a LOW-LOSS
CAPACITOR?")
980|         If Reply = 0 Then
990|             Result = Cal("LOW-LOSS C")
1000|             If Result <> 0 Then GoTo Prog_int
1010|             End If
1020|
1030|             SCPI.Output "SENS:CORR1:COLL:SAVE"
1040|             buff = SCPI.Query("*OPC?")
1050|             MsgBox "All cal-data measurement completion", vbOKOnly,
"Calibration"
1060|
1070|     Cal_skip:
1080|
1090|         ' STEP4: Connect the Test Fixture
1100|         ' STEP5: Setting the Electrical Length of the Test
Fixture
1110|
1120|         Reply = Message("Connect the " & Fixture & " test
fixture to the E4991A.")
1130|         If Reply <> 0 Then GoTo Prog_int
1140|         SCPI.Output "SENS:CORR2:FIXT " & Fixture
1150|         buff = SCPI.Query("*OPC?")
1160|
1170|         ' STEP6: Compensation (FIXED)
1180|
1190|         ' Initial Settings
1200|
1210|         SCPI.Output "SENS:CORR2:COLL:FPO " & Cal_type
1220|
1230|         ' Data Measurement
1240|
1250|         Result = Fixt_comp("OPEN")
1260|         If Result <> 0 Then GoTo Prog_int
1270|
1280|         Result = Fixt_comp("SHORT")
1290|         If Result <> 0 Then GoTo Prog_int
1300|
1310|         SCPI.Output "SENS:CORR2:COLL:SAVE"
1320|         buff = SCPI.Query("*OPC?")
1330|         MsgBox "All compen-data measurement completion",
vbOKOnly, "Compensation"
1340|
1350|         ' STEP7: Connect the DUT (Chip Inductor)
1360|
1370|     Meas_start:
1380|         Reply = Message("Connect the DUT to electrode plate on
the fixture.")
1390|         If Reply <> 0 Then GoTo Prog_int
```

## Application Programs

### Basic Measurement

```
1400|
1410|         ' STEP8: Auto Scaling & Maximum Point Search
1420|
1430|         ' Performing a Single Sweep
1440|
1450|         SCPI.Output "CALC:AVER:CLE"
1460|         Answer = SingleMeasure
1470|         If Answer = 0 Then
1480|             MsgBox "A single sweep aborted", vbOKOnly, "Impedance
measurement"
1490|             GoTo Prog_int
1500|         End If
1510|
1520|         ' Performing an Auto-scale
1530|
1540|     Auto_scaling:
1550|         SCPI.Output "DISP:TRAC1:Y:AUTO"
1560|         SCPI.Output "DISP:TRAC2:Y:AUTO"
1570|         SCPI.Output "DISP:TRAC3:Y:AUTO"
1580|
1590|         ' Searching the Maximum Value
1600|
1610|         SCPI.Output "CALC1:MARK1 ON"
1620|         SCPI.Output "CALC1:MARK1:ACT"
1630|         SCPI.Output "CALC1:MARK:FUNC " & Mkr_src
1640|         SCPI.Output "CALC1:MARK:FUNC:EXEC"
1650|
1660|         ' Reading a marker's value
1670|
1680|         SCPI.Output "CALC1:MARK1:X?"
1690|         SCPI.Enter Freq_val
1700|         SCPI.Output "CALC1:MARK1:Y?"
1710|         SCPI.Enter Imp_val
1720|
1730|         ' Displaying Measurement Result
1740|
1750|         Reply = Message("Frequency: " & CStr(Freq_val /
1000000#) & "[MHz]" & _
1760|                               vbCrLf & "Impedance: " & CStr(Imp_val)
& "[ohm]" & _
1770|                               vbCrLf & vbCrLf & "Performing a
measurement again?")
1780|         If Reply = 0 Then GoTo Meas_start
1790|         MsgBox "Program ended!", vbOKOnly, "Impedance
measurement"
1800|         GoTo Prog_end
1810|
1820|     Prog_int:
1830|         MsgBox "Program interruption", vbOKOnly, "Impedance
measurement"
1840|
1850|     Prog_end:
1860|
1870|         Set Err.Evnt = Nothing
1880|
1890|     End Sub
1900|
1910|     Function Cal(Standard As String) As Integer
```

```
1920|
1930|     Dim Reply As Integer
1940|     Dim Answer As Long
1950|
1960|     Reply = Message("Connect " & Standard & " standard to
DUT port.")
1970|
1980|     If Reply = 0 Then
1990|         Select Case Standard
2000|             Case "OPEN"
2010|                 Answer = CalMeasure(CalOpen)
2020|             Case "SHORT"
2030|                 Answer = CalMeasure(CalShort)
2040|             Case "LOAD"
2050|                 Answer = CalMeasure(CalLoad)
2060|             Case "LOW-LOSS C"
2070|                 Answer = CalMeasure(CalLowLossC)
2080|             End Select
2090|             If Answer = 0 Then
2100|                 MsgBox Standard & " Calibration aborted!", vbOKOnly,
"Calibration"
2110|                 Cal = -1
2120|             Else
2130|                 Cal = 0
2140|             End If
2150|         Else
2160|             Cal = -1
2170|         End If
2180|
2190|     End Function
2200|
2210|     Function Fixt_comp(Standard As String) As Integer
2220|
2230|         Dim Reply As Integer
2240|         Dim Answer As Long
2250|
2260|         Reply = Message("Connect " & Standard & " standard to
electrode plate on the test fixture.")
2270|
2280|         If Reply = 0 Then
2290|             Select Case Standard
2300|                 Case "OPEN"
2310|                     Answer = CompenMeasure(CompenOpen)
2320|                 Case "SHORT"
2330|                     Answer = CompenMeasure(CompenShort)
2340|                 End Select
2350|                 If Answer = 0 Then
2360|                     MsgBox Standard & " Compensation aborted!",
vbOKOnly, "Compensation"
2370|                     Fixt_comp = -1
2380|                 Else
2390|                     Fixt_comp = 0
2400|                 End If
2410|             Else
2420|                 Fixt_comp = -1
2430|             End If
2440|
2450|     End Function
```

## Application Programs

### Basic Measurement

```
2460|
2470|         Function Message(Mes As String) As Integer
2480|
2490|             Dim Inp_char As Integer
2500|
2510|             Inp_char = MsgBox(Mes, vbYesNo + vbQuestion, "Impedance
measurement")
2520|
2530|             If Inp_char = vbYes Then
2540|                 Message = 0
2550|             Else
2560|                 Message = -1
2570|             End If
2580|
2590|         End Function
```

#### Example 16-3

#### Measuring the self-resonant point of an inductor (bsc\_meas.cls)

When using the event provided in the E4991A, the following programming steps are created.

- Public WithEvents *event variable* As E4991ALib.Application
- Private Sub *event variable*\_Event ( )  
~
- End Sub

The details of the program (bsc\_meas.cls) are explained below. The line numbers are added for explanatory purposes but are not usually displayed.

Line 20	Defines the variable (Evnt) as the Public type so that the event procedure can be used in different procedures.
Lines 40 - 90	Terminates the program when a “PLL unlock” error occurs inside the E4991A.
Lines 110 - 160	Terminates the program when a “DC bias overload” error occurs inside the E4991A.
Lines 180 - 230	Forces the program to end when an “RF overload” error occurs inside the E4991A.

```
10|
20| Public WithEvents Evnt As E4991ALib.Application
30|
40| Private Sub Evnt_Unlocked()
50|
60| MsgBox "Error: PLL Unlock" & vbCrLf & vbCrLf & "Program interruption", vbExclamation,
"E4991A Internal Error"
70| End
80|
90| End Sub
100|
110| Private Sub Evnt_DeBiasOverload()
120|
130| MsgBox "Error: Dc bias overload" & vbCrLf & vbCrLf & "Program interruption",
vbExclamation, "E4991A Internal Error"
140| End
```

```
150|  
160| End Sub  
170|  
180| Private Sub Evnt_RfOverload()  
190|  
200| MsgBox "Error: RF overload" & vbCrLf & vbCrLf & "Program interruption", vbExclamation,  
"E4991A Internal Error"  
210| End  
220|  
230| End Sub  
240|
```



---

## 17 GPIB Command Reference

This chapter provides the GPIB command reference of the Agilent E4991A. The command references are written in abbreviated form and listed in alphabetic order.

---

## Conventions

This section defines the terms and symbols used as conventions in the command references.

## Format

The section titled “Format” shows the format(s) that is (are) used to transmit the command to the E4991A. Each format consists of the command label and parameter fields, which are separated by spaces.

If two or more parameters appear in a format, they are separated by commas (.). Two periods (..) inserted between commas indicate that at least one parameter has been omitted. If there are character string parameters (e.g., <character-string>, <character-string-1>), each parameter must be enclosed within double quotation marks (").

Any lowercase alphabetic characters in a command may be omitted. For example, the command label **:SYSTem:PRESet** may be abbreviated to the **SYST:PRES** command on page 523.

The following symbols are used in the format section:

- ◊ A character string enclosed within angle brackets represents a parameter that is required to transmit the command.
- [] Anything enclosed within brackets may be omitted.
- { } Only one of the items enclosed within braces can be selected. These items are separated by vertical strokes (|).

## Description

The section titled “Description” describes how to use the command and what it does when executed.



## Parameters

The section titled “Parameters” describes the parameters required to transmit the command. If a parameter is of a numeric (integer or floating-point) or a character string type and enclosed within angle brackets (<>), the “Parameters” section contains the parameter’s description, range, initial setting, etc. If a parameter is enclosed within braces ({ }), i.e., selectable, the section contains a description of the options.

### Data format

The E4991A uses the following data types for parameter input. These also apply to Query responses.

#### 1. Numeric data (ASCII data)

Numeric values are transmitted in one of the following formats:

- Integer type

A numeric value is represented as an integer. For example, numeric value 201 is represented as "+201". The sign at the head is omitted in some cases.

- Floating-point type

Floating-point data are represented as a numeric value including the decimal point. For example, numeric value 1000 is represented as "+1.0E+3". The sign at the head is omitted in some cases.

The real and imaginary parts of complex data are represented in floating-point format.

#### 2. Character data

ASCII character data are used for character data. For example, **POL** represents the polar coordinate format used when the E4991A setting is verified by Query. Character data are similar to character string data; however, character string data are enclosed within double quotation marks (" "), whereas character data are not.

#### 3. Character string data

ASCII character data enclosed within double quotation marks are used for character string data. For example, when setting the trace title, type a character string enclosed within double quotations to represents the title (e.g., "**Measurement Data**").

#### 4. Block data (binary data)

The first digit following the pound symbol (#) represents the number of digits in the number of bytes of the subsequent data. The next digit actually represents the number of bytes of the data transferred. For example, the seven-byte data ABC+XYZ is represented as "#17ABC+XYZ<newline><^END>".

## Query response

The section titled “Query response” shows the format of the data that are read out when the command can enable Query (i.e., data readout).

The parameters read out are enclosed within braces ( { } ). If the pair of braces contains items separated by vertical strokes ( | ), this indicates that only one of them will be read out.

If two or more parameters are to be read out, they are separated by commas ( , ). Two periods ( . ) inserted between commas indicate that the data are omitted. For example, "{numeric 1},...,{numeric 4}" indicates that the four items {numeric 1},{numeric 2},{numeric 3},{numeric 4} will be read out.

<newline><^END> appended to the parameter field is the program message terminator.

## Related command(s)

The section titled “Related command(s)” lists one or more commands related to the currently described one.

## Front Panel Equivalents

The section titled “Front Panel Equivalents” shows the operation of the front panel keys that has the same effect as executing the currently described command.

## IEEE subsystem

This section describes the GPIB commands of the IEEE subsystem.

### \*CLS

Format	*CLS
Description	<p>Initializes the following. (No query)</p> <ul style="list-style-type: none"> <li>• Error Queue</li> <li>• Status Byte Register</li> <li>• Operation Status Register</li> <li>• Questionable Status Register</li> <li>• Questionable Status Hardware Register</li> <li>• Questionable Status Limit Register</li> <li>• Questionable Status Search Register</li> <li>• Standard Event Status Register</li> </ul>
Front Panel Equivalents	Unavailable.

**\*ESE**

**\*ESE**

Format \*ESE <numeric>  
\*ESE?

Description Sets the value of the Standard Event Status Enable register.  
See Figure B-3, “Status Register Structure (1/2),” on page 557, for details of the status register structure.

Parameters

	<b>&lt;numeric&gt;</b>
Description	Value of the Enable register
Data type	Integer
Range	0 to 255
Default	0

If the specified parameter is outside the range, the bit-by-bit logical sum resulting from an AND operation with 255 (0xff) will be assumed.

Query response {numeric}<newline><^END>

Related command **\*ESR?** command on page 280

Front Panel Equivalents Unavailable.

**\*ESR?**

Format \*ESR?

Description Returns the value of the Standard Event Status register. Execution of the command clears the register value. (Query only)

See Figure B-3, “Status Register Structure (1/2),” on page 557, for details of the status register structure.

See Table B-2, “Status Bit Definition of Standard Event Status Register,” on page 560 for the bit definition of the Standard Event Status register.

Query response {numeric}<newline><^END>  
Returns the integer value.

Front Panel Equivalents Unavailable.

**\*IDN?**

Format	*IDN?
Description	Returns the E4991A product information. (Query only)
Query response	<pre>{string 1},{string 2},{string 3},{string 4}&lt;newline&gt;&lt;^END&gt;</pre> <p>The following product information is read out:</p> <pre>{string 1}      Manufacturer. Always "Agilent Technologies".</pre> <pre>{string 2}      Model number. Always "E4991A".</pre> <pre>{string 3}      Serial number</pre> <pre>{string 4}      Firmware version number (e.g., "01.00")</pre>
Front Panel Equivalents	Unavailable.

**\*OPC**

Format	*OPC
Description	When all the pending operations have ended, sets OPC bit (Bit 0) of the Standard Event Status Register. (No query)
Front Panel Equivalents	Unavailable.

**\*OPC?**

Format	*OPC?
Description	Returns 1 when all the pending operations end. (Query only)
Query response	{1}<newline><^END>
Front Panel Equivalents	Unavailable.

**\*OPT?**

**\*OPT?**

Format	*OPT?
Description	Returns the identification code(s) of the option(s) installed on the E4991A. If no option is installed, this command returns 0. If two or more options are installed, it returns a string of the option identification codes separated by commas (.). (Query only)  The E4991A offers the following option identification codes:
	0                    No Option
	001                 dc bias function
	1D5                 High Stability Frequency Reference
	002                 Material Measurement Software
Query response	{string}<newline><^END>
Front Panel Equivalents	Unavailable.

**\*RST**

Format	*RST
Description	Resets the E4991A to its initial settings. Initialization by the <b>SYST:PRES</b> command and trigger setting by the <b>INIT:CONT OFF</b> command take place. (No query)
Related commands	<b>INIT:CONT</b> command on page 382 <b>SYST:PRES</b> command on page 523
Front Panel Equivalents	Unavailable.

**\*SRE**

Format            \*SRE <numeric>  
                   \*SRE?

Description       Sets the value of the Service Request Enable register.  
                   See Figure B-3, “Status Register Structure (1/2),” on page 557, for details of the status register structure.

Parameters

	<numeric>
Description	Setting of the Register
Data type	Integer
Range	0 to 255
Default	0

If the specified parameter is outside the range, the bit-by-bit logical sum resulting from an AND operation with 255 (0xff) will be assumed. Bit 6 cannot be set to 1.

Query response    {numeric}<newline><^END>

Related commands **\*STB?** command on page 283

Front Panel  
 Equivalents      Unavailable.

**\*STB?**

Format            \*STB?

Description       Returns the value of the Status Byte register. (Query only)  
                   See Figure B-3, “Status Register Structure (1/2),” on page 557, for details of the status register structure.  
                   See Table B-1, “Status Bit Definition of Status Byte Register,” on page 559 for the bit definition of the Status Byte register.

Query response    {numeric}<newline><^END>  
                   Returns the integer value.

Front Panel  
 Equivalents      Unavailable.

**\*TRG**

**\*TRG**

Format \*TRG

Description Triggers the E4991A when the trigger source has been set for the GPIB (specified as "BUS" in the **TRIG:SOUR**).

Related commands **TRIG:SOUR** command on page 526

Front Panel Equivalents Unavailable.

**\*TST?**

Format \*TST?

Description Executes a self-test and returns the test results. (Query only)

Query response {numeric}<newline><^END>

	Description
0	Result of the self-test is PASS.
except 0	Result of the self-test is FAIL.

Front Panel Equivalents **System - Diagnostic - Internal Test** - Test Start

**\*WAI**

Format \*WAI

Description Prohibits the instrument from executing any new commands until all pending overlapped commands have been completed. (No query)

Front Panel Equivalents Unavailable.



**Table 17-1 Overlapped Commands**

**DISPlay Subsystem:**

**DISP:TEXT** on page 355

**CALCulate:MARKer Subsystem:**

**CALC{1-5}:MARK:SET** on page 336

**SENSe:CORRection Subsystem:**

**SENS:CORR1:COLL** on page 437

**SENS:CORR1:COLL:FPO** on page 438

**SENS:CORR1:COLL:SAVE** on page 439

**SENS:CORR2:COLL** on page 449

**SENS:CORR2:COLL:FPO** on page 450

**SENS:CORR2:COLL:SAVE** on page 451

**SENS:CORR2:FIXT** on page 454

**SENS:CORR2:FIXT:EDEL:USER:DIST** on page 456

**SENSe:AVERage Subsystem:**

**AVER** on page 287

**AVER:COUN** on page 288

**SENSe:FREQuency Subsystem:**

**FREQ** on page 375

**FREQ:CENT** on page 376

**FREQ:SPAN** on page 377

**FREQ:SPAN:FULL** on page 377

**FREQ:STAR** on page 378

**FREQ:STOP** on page 379

**SENSe:MODE Subsystem:**

**MODE** on page 393

**SENSe:SEGMENT Subsystem:**

**SEGM{1-16}:CURR** on page 398

**SEGM{1-16}:CURR:LIM** on page 400

**SEGM{1-16}:CURR:OFFS** on page 401

**SEGM{1-16}:DATA** on page 403

**SEGM:DATA:ALL** on page 405

**SEGM:DEL:ALL** on page 406

**SEGM{1-16}:FREQ:CENT** on page 407

**SEGM{1-16}:FREQ:SPAN** on page 408

**SEGM{1-16}:FREQ:STAR** on page 409

**SEGM{1-16}:FREQ:STOP** on page 410

**SEGM{1-16}:POW** on page 411

**SEGM{1-16}:SWE:POIN** on page 413

**SEGM{1-16}:VOLT** on page 414

**SEGM{1-16}:VOLT:LIM** on page 415

**SEGM{1-16}:VOLT:OFFS** on page 416

**SENSe:SWEep Subsystem:**

**SWE:DIR** on page 508

**SWE:DWEL1** on page 508

**SWE:DWEL2** on page 509

**SWE:DWEL3** on page 510

**SWE:POIN** on page 511

**SWE:TIME** on page 513

**SWE:TIME:AUTO** on page 514

**SWE:TYPE** on page 515

**SOURce Subsystem:**

All of the commands

## **E4991A GPIB command**

This section describes the GPIB commands specific to E4991A.

### **ABOR**

Format	ABORt
Description	Resets the trigger system to put the trigger sequence in the idle state. Also sets the continuous activation of trigger system to off. (No query)
Related commands	<b>INIT:CONT</b> command on page 382 <b>INIT</b> command on page 382
Front Panel Equivalents	Unavailable.

## AVER

Format [SENSe:]AVERage[:STATe] {ON|OFF|1|0}  
 [SENSe:]AVERage[:STATe]?

Description Turns on/off the point averaging function.  
 In addition, use the **AVER:COUN** command to set the averaging factor.

### Parameters

	Description
ON or 1 (Default)	Turns on the point averaging function.
OFF or 0	Turns off the point averaging function.

Query response {1|0}<newline><^END>

Related commands **AVER:COUN** command on page 288

Front Panel Equivalents **Stimulus - Sweep Setup...** - Point Average

## **AVER:COUN**

Format [SENSe:]AVERage:COUNT <numeric>  
[SENSe:]AVERage:COUNT?

Description Sets the averaging factor when using the point averaging function. Only setting the averaging factor does not set the point averaging function to on. Use the **AVER** command to set the point averaging function to on.

In addition, use the **SEGM{1-16}:AVER:COUN** command to set the point averaging factor for the segment sweep.

### Parameters

	<numeric>
Description	Point averaging factor
Data type	Integer
Range	1 to 100
Default	1

If the specified parameter is outside the range, the minimum (if the lower limit of the range is exceeded) or maximum value (if the upper limit is exceeded) will be assumed.

Query response {numeric}<newline><^END>

Related commands **AVER** command on page 287  
**SEGM{1-16}:AVER:COUN** command on page 396

Front Panel  
Equivalents **Stimulus - Sweep Setup...** - Point Average

## CALC: AVER

**Format**                   CALCulate: AVERage[:STATe] {ON|OFF|1|0}  
 CALCulate: AVERage[:STATe]?

**Description**           Turns on/off the sweep averaging function.  
 In addition, use the **CALC: AVER: COUN** command to set the averaging factor.

**Parameters**

	Description
ON or 1	Turns on the sweep averaging function.
OFF or 0 (Default)	Turns off the sweep averaging function.

**Query response**       {1|0}<newline><^END>

**Related commands**   **CALC: AVER: COUN** command on page 290

**Front Panel  
 Equivalents**           **Meas/Format - Meas/Format...** - Sweep Average[On/Off]

## CALC: AVER: CLE

**Format**                   CALCulate: AVERage: CLEar

**Description**           Resets the sweep averaging. Also restarts the sweep from the sweep count 1 when the E4991A is performing sweep. (No query)

**Front Panel  
 Equivalents**           **Meas/Format - Meas/Format...** - Sweep Average Restart

## **CALC:AVER:COUN**

**Format**           CALCulate:AVERage:COUNT <numeric>  
CALCulate:AVERage:COUNT?

**Description**       Sets the averaging factor when using the sweep averaging function. Only setting the averaging factor does not set the sweep averaging function to on.  
In addition, use the **CALC:AVER** command to set the sweep averaging function to on.

### Parameters

	<b>&lt;numeric&gt;</b>
Description	Sweep averaging factor
Data type	Integer
Range	1 to 999
Default	16

If the specified parameter is outside the range, the minimum (if the lower limit of the range is exceeded) or maximum value (if the upper limit is exceeded) will be assumed.

**Query response**    {numeric}<newline><^END>

**Related commands** **CALC:AVER** command on page 289

**Front Panel**       **Meas/Format - Meas/Format...** - Swp Avg Count  
**Equivalents**

## CALC:BMON

Format	CALCulate[:EVALuate]:BMONitor[:STATe] {ON OFF 1 0} CALCulate[:EVALuate]:BMONitor[:STATe]?						
Description	<p>Turns on/off the dc bias monitor function. This command is available when Option 001 (dc bias function) is installed.</p> <p>It is necessary to set markers with the <b>CALC{1-5}:MARK{1-8}</b> command or the <b>CALC{1-5}:MARK:REF</b> command before sending this command.</p> <p>In addition, use the <b>CALC:DATA:MON?</b> command to read the dc bias level monitor array.</p>						
Parameters	<table border="1" style="width: 100%; border-collapse: collapse;"> <thead> <tr> <th style="width: 50%;"></th> <th style="text-align: center;">Description</th> </tr> </thead> <tbody> <tr> <td>ON or 1</td> <td>Turns on the dc bias monitor function.</td> </tr> <tr> <td>OFF or 0 (Default)</td> <td>Turns off the dc bias monitor function.</td> </tr> </tbody> </table>		Description	ON or 1	Turns on the dc bias monitor function.	OFF or 0 (Default)	Turns off the dc bias monitor function.
	Description						
ON or 1	Turns on the dc bias monitor function.						
OFF or 0 (Default)	Turns off the dc bias monitor function.						
Query response	{1 0}<newline><^END>						
Related commands	<p><b>CALC:DATA:MON?</b> command on page 292</p> <p><b>CALC{1-5}:MARK{1-8}</b> command on page 304</p> <p><b>CALC{1-5}:MARK:REF</b> command on page 328</p>						
Front Panel Equivalents	<b>Stimulus - Source...</b> - Bias Monitor: [On/Off]						

## **CALC:DATA:MON?**

Format           CALCulate:DATA:MONitor? {V|I}

Description       Reads the dc bias level monitor array of all measurement points. This command is available when Option 001 (dc bias function) is installed. The dc bias monitor function has to be set to on by using the **CALC:BMON** command before sending this command. (Query only)

### Parameters

	Description
V	Specifies the voltage value.
I	Specifies the current value.

Query response   {numeric 1}, {numeric 2},..., {numeric N-1}, {numeric N}<newline><^END>  
Where N is the number of measurement points.  
It is read in the floating-point value.

Related commands **CALC:BMON** command on page 291  
**FORM:DATA** command on page 374

Front Panel       Unavailable.  
Equivalents



## CALC{1-5}:DATA?

Format CALCulate{1-5}:DATA? {FDATA|FMEM}

Description Reads the data trace array or the memory trace array. (Query only)

Parameters

Sub-block	Description
CALCulate{1-5}	Specifies the trace number (1 to 5)

	Description
FDATA	Specifies the data trace array
FMEM	Specifies the memory trace array

The memory trace array stores the data trace array's content copied with the **CALC{1-5}:MATH:MEM** command or the frequency characteristic simulation results by executing the **CALC{1-5}:EPAR:SIM** command in the equivalent circuit analysis.

Query response

- With scalar trace  
{numeric 1}, {numeric 2},..., {numeric N-1}, {numeric N}<newline><^END>

	Description
{numeric n}	Data at the n-th measurement point

- With complex trace  
{numeric 1}, {numeric 2},..., {numeric N×2-1}, {numeric N×2}<newline><^END>

	Description
{numeric n × 2 - 1}	Real part of data (complex type) at the n-th measurement point
{numeric n × 2}	Imaginary part of data (complex type) at the n-th measurement point

Where N is the number of measurement points.

It is read in the floating-point value.

Related commands **CALC{1-5}:MATH:MEM** command on page 341

Front Panel Equivalents Unavailable.

## CALC{1-5}:DATA:EPAR

**Format**                   CALCulate{1-5}:DATA:EPARparameter {EQC0|EQC1|EQL1|EQR1},<numeric>  
 CALCulate{1-5}:DATA:EPARparameter? {EQC0|EQC1|EQL1|EQR1}

**Description**           Sets each value of equivalent circuit parameters.

**Parameters**

Sub-block	Description
CALCulate{1-5}	Specifies the trace number (1 to 5).

	Description
EQC0	Equivalent circuit parameter C0
EQC1	Equivalent circuit parameter C1
EQL1	Equivalent circuit parameter L1
EQR1	Equivalent circuit parameter R1

	<numeric>
Description	Equivalent circuit parameter value
Data type	Floating point
Default	0
Unit	F (for C0 and C1), H (for L1), and $\Omega$ (for R1)

**Query response**       {numeric}<newline><^END>

**Front Panel**           **Utility - Equivalent Circuit...** - R1|C1|L1|C0  
**Equivalents**

## CALC{1-5}:EPAR

**Format**                   CALCulate{1-5}:EPARameters

**Description**           Executes the equivalent circuit analysis in the selected equivalent circuit model. In addition, executes the equivalent circuit analysis in the marker partial search range. When the marker partial search range is not set to on with the **CALC{1-5}:MARK:FUNC:DOM** command, executes the equivalent circuit analysis in the entire sweep range. (No query)

In addition, use the **CALC{1-5}:EPAR:CIRC** command to select the equivalent circuit mode.

Also, the equivalent circuit parameters C0, C1, L1, and R1 that were acquired in the equivalent circuit analysis can be read when executing the **CALC{1-5}:DATA:EPAR** command in the query.

**Parameters**

Sub-block	Description
CALCulate{1-5}	Specifies the trace number (1 to 5).

**Related commands**   **CALC{1-5}:EPAR:CIRC** command on page 296  
**CALC{1-5}:DATA:EPAR** command on page 294

**Front Panel  
Equivalents**           **Utility - Equivalent Circuit...** - Calculate Parameters

## **CALC{1-5}:EPAR:CIRC**

**Format**                   CALCulate{1-5}:EPARameters:CIRCuit[:TYPE] {A|B|C|D|E}  
CALCulate{1-5}:EPARameters:CIRCuit[:TYPE]?

**Description**           Specifies the equivalent circuit model in the equivalent circuit analysis.

**Parameters**

<b>Sub-block</b>	<b>Description</b>
CALCulate{1-5}	Specifies the trace number (1 to 5).

	<b>Description</b>
A (Default)	Specifies the equivalent circuit model A
B	Specifies the equivalent circuit model B
C	Specifies the equivalent circuit model C
D	Specifies the equivalent circuit model D
E	Specifies the equivalent circuit model E

**Query response**       {A|B|C|D|E}<newline><^END>

**Front Panel  
Equivalents**           **Utility - Equivalent Circuit...** - Select Circuit - A|B|C|D|E

## CALC{1-5}:EPAR:SIM

Format           CALCulate{1-5}:EPARameters:SIMulation

Description       Simulates and displays the frequency characteristic of the equivalent circuit. (No query)  
 In addition, the simulation result is stored in the memory trace so that it can be read with the **CALC{1-5}:DATA?** command.

Parameters

Sub-block	Description
CALCulate{1-5}	Specifies the trace number (1 to 5).

Related commands   **CALC{1-5}:DATA?** command on page 293

Front Panel  
 Equivalents       **Utility - Equivalent Circuit...** - Simulate Freq-Char

## CALC{1-5}:FORM

**Format**

- With scalar trace  
 CALCulate{1-3}:FORMat  
 {Z|Y|LS|LP|CS|CP|RS|RP|D|Q|R|X|G|B|ZPH|YPH|RC|RCPH|RCX|RCY|P|PRE|PLF|P  
 LT|DC|DCR|DCLF|DCLT}  
 CALCulate{1-3}:FORMat?
- With complex trace  
 CALCulate{4-5}:FORMat {Z|Y|RC|P|DC}  
 CALCulate{4-5}:FORMat?

**Description**

Sets the measurement parameters. A maximum of five measurement parameters can be arbitrarily selected.

**Parameters**

The following measurement parameters can be selected:

- With scalar trace:

Sub-block	Description
CALCulate{1-3}	Specifies the trace number (1 to 3).

	Description
Z	Absolute value of impedance ( $ Z $ )
Y	Absolute value of admittance ( $ Y $ )
LS	Equivalent series inductance ( $L_s$ )
LP	Equivalent parallel inductance ( $L_p$ )
CS	Equivalent series capacitance ( $C_s$ )
CP	Equivalent parallel capacitance ( $C_p$ )
RS	Equivalent series resistance ( $R_s$ )
RP	Equivalent parallel resistance ( $R_p$ )
D	Dissipation factor ( $D$ )
Q	Quality factor ( $Q$ )
R	Series resistance ( $R$ )
X	Reactance ( $X$ )
G	Conductance ( $G$ )
B	Susceptance ( $B$ )
ZPH	Phase of impedance ( $\theta_z$ )
YPH	Phase of admittance ( $\theta_y$ )

	Description
RC	Absolute value of reflection coefficient ( $ \Gamma $ )
RCPH	Phase of reflection coefficient ( $\theta\gamma$ )
RCX	Real part of reflection coefficient ( $\Gamma_x$ )
RCY	Imaginary part of reflection coefficient ( $\Gamma_y$ )
p* <sup>1</sup>	Absolute value of complex permeability ( $ \mu_r $ )
PRE* <sup>1</sup>	Real part of complex permeability ( $\mu_r'$ )
PLF* <sup>1</sup>	Imaginary part of complex permeability ( $\mu_r''$ )
PLT* <sup>1</sup>	Magnetic loss tangent ( $\tan\delta(\mu)$ )
DC* <sup>2</sup>	Absolute value of complex permittivity ( $ \epsilon_r $ )
DCR* <sup>2</sup>	Real part of complex permittivity ( $\epsilon_r'$ )
DCLF* <sup>2</sup>	Imaginary part of complex permittivity ( $\epsilon_r''$ )
DCLT* <sup>2</sup>	Dielectric loss tangent ( $\tan\delta(\epsilon)$ )

\*1. Can be selected when magnetic measurement mode is selected with the **MODE** command.

\*2. Can be selected when electric measurement mode is selected with the **MODE** command.

- With complex trace:

Sub-block	Description
CALCulate {4-5}	Specifies the trace number (4 to 5)

	Description
Z	Impedance ( $Z$ )
Y	Admittance ( $Y$ )
RC	Reflection coefficient ( $\Gamma$ )
p* <sup>1</sup>	Complex permeability ( $\mu_r$ )
DC* <sup>2</sup>	Complex permittivity ( $\epsilon_r$ )

\*1. Can be selected when magnetic measurement mode is selected with the **MODE** command.

\*2. Can be selected when electric measurement mode is selected with the **MODE** command.

- Query response
- With scalar trace:  
 {Z|Y|LS|LP|CS|CP|RS|RP|D|Q|R|X|G|B|ZPH|YPH|RC|RCPH|RCX|RCY|P|PRE|PLF|P  
 LT|DC|DCR|DCLF|DCLT}<newline><^END>
  - With complex trace  
 {Z|Y|RC|P|DC}<newline><^END>

Related commands **MODE** command on page 393

Front Panel Equivalents **Meas/Format - Meas/Format...** - Meas Parameter

## CALC:FORM:PAR:DIE

Format  
 CALCulate:FORMat:PARAmeter:DIElectric <numeric>  
 CALCulate:FORMat:PARAmeter:DIElectric?

Description Sets the thickness of dielectric material in the dielectric measurement. This command is available when Option 002 (material measurement software) is installed.

Parameters

	<numeric>
Description	Thickness of dielectric material
Data type	Floating point
Range	1E-6 to 4.8E-3
Default	1E-6
Resolution	1E-10
Unit	m (meter)

If the specified parameter is outside the range, the minimum (if the lower limit of the range is exceeded) or maximum value (if the upper limit is exceeded) will be assumed.

Query response {numeric}<newline><^END>

Front Panel Equivalents **Utility - Material Option...** - Thickness



## CALC{1-3}:FORM:PAR:EPH

**Format**                   CALCulate{1-3}:FORMat:PARameter:EPHase {ON|OFF|1|0}  
 CALCulate{1-3}:FORMat:PARameter:EPHase?

**Description**           Turns on/off the expanded phase display function, which allows phases to be below -180 or above 180 degrees, when the measurement parameter is the phase. This command is ignored for measurement parameters other than phase.

**Parameters**

Sub-block	Description
CALCulate{1-3}	Specifies the trace number (1 to 3).

	Description
ON or 1 (Default)	Set the expanded phase display to on.
OFF or 0	Set the expanded phase display to off.

**Query response**       {1|0}<newline><^END>

**Front Panel  
 Equivalents**           **Meas Format - Meas/Format...** - Expand Phase [On/Off]

## CALC:FORM:PAR:MAG

**Format**                   CALCulate:FORMat:PARameter:MAGnetic <numeric 1>,<numeric 2>,<numeric 3>  
 CALCulate:FORMat:PARameter:MAGnetic?

**Description**           Sets the inner diameter, outer diameter, and height of the toroidal core in the magnetic measurement. This command is available when Option 002 (material measurement software) is installed.

**Parameters**

	<numeric 1>	<numeric 2>	<numeric 3>
Description	Inner diameter of core	Outer diameter of core	Height of core
Data type	Floating point	Floating point	Floating point
Range (16454S)	3.04E-3 to 9E-3	3.04E-3 to 9E-3	1E-5 to 3.65E-3
Range (16454L)	3E-3 to 21E-3	3E-3 to 21E-3	1E-5 to 11.6E-3
Default (16454S)	3.04E-3	9E-3	3.65E-3
Default (16454L)	3E-3	21E-3	11.6E-3
Resolution	1E-7	1E-7	1E-9
Unit	m (meter)	m (meter)	m (meter)

If the specified parameter is outside the range, the minimum (if the lower limit of the range is exceeded) or maximum value (if the upper limit is exceeded) will be assumed.

**Query response**       {numeric 1}, {numeric 2}, {numeric 3}<newline><^END>

**Front Panel  
Equivalents**           **Utility - Material Option...** - Height|Inner Diameter|Outer Diameter

## CALC{1-5}:FORM:UNIT:ANGL

**Format**            CALCulate{1-5}:FORMat:UNIT:ANGLE {DEG|RAD}  
                       CALCulate{1-5}:FORMat:UNIT:ANGLE?

**Description**        Sets the display unit for the phase display format.

**Parameters**

Sub-block	Description
CALCulate{1-5}	Specifies the trace number (1 to 5).

	Description
DEG (Default)	Specifies the display unit as degree (°).
RAD	Specifies the display unit as radian.

**Query response**    {DEG|RAD}<newline><^END>

**Related commands** **CALC{1-5}:FORM** command on page 298

**Front Panel**        **Meas/Formet - Meas/Format...** - Phase Unit [Degree/Radian]  
**Equivalents**

## **CALC{1-5}:MARK{1-8}**

**Format**                   CALCulate{1-5}:MARKer{1-8}[:STATe] {ON|OFF|1|0}  
 CALCulate{1-5}:MARKer{1-8}[:STATe]?

**Description**           Turns on/off markers 1-8.

In addition, use the **CALC{1-5}:MARK:REF** command to turn on/off the reference marker.

Also, use the **CALC{1-5}:MARK:AOFF** command to simultaneously turn off all of the markers displayed on the trace.

**Parameters**

<b>Sub-block</b>	<b>Description</b>
CALCulate{1-5}	Specifies the trace number (1 to 5).
MARKer{1-8}	Specifies the marker number (1 to 8).

	<b>Description</b>
ON or 1	Turns on the marker.
OFF or 0 (Default)	Turns off the marker.

**Query response**       {1|0}<newline><^END>

**Related commands**   **CALC{1-5}:MARK:REF** command on page 328  
**CALC{1-5}:MARK:AOFF** command on page 305

**Front Panel**           **Marker - Marker...** - Select Marker  
**Equivalents**           **Marker - Marker...** - Selected Marker [On/Off]

## CALC{1-5}:MARK{1-8}:ACT

Format CALCulate{1-5}:MARKer{1-8}:ACTivate

Description Sets the specified marker to the active marker. (No query)

In addition, use the **CALC{1-5}:MARK:REF:ACT** command to set the reference marker to the active marker.

Parameters

Sub-block	Description
CALCulate{1-5}	Specifies the trace number (1 to 5).
MARKer{1-8}	Specifies the marker number (1 to 8).

Related commands **CALC{1-5}:MARK:REF:ACT** command on page 329

Front Panel **Marker - Marker...** - Select Marker

Equivalents

Alternatively, click on the specified marker directly.

## CALC{1-5}:MARK:AOFF

Format CALCulate{1-5}:MARKer:AOFF

Description Turns off all markers displayed on the trace. (No query)

Parameters

Sub-block	Description
CALCulate{1-5}	Specifies the trace number (1 to 5).

Related commands **CALC{1-5}:MARK{1-8}** command on page 304

**CALC{1-5}:MARK:REF** command on page 328

Front Panel **Marker - All Off**

Equivalents

## **CALC{1-5}:MARK:APE:SET**

Format CALCulate{1-5}:MARKer:APEak:SET

Description Sets the  $\Delta X$  and  $\Delta Y$  values of peak definition so that the active marker position is recognized as the peak. Therefore,  $\Delta X$  is set to the stimulus value difference between the active marker and the adjacent left measurement point, while  $\Delta Y$  is set to the measurement value difference between them. When the  $\Delta$  mode is set to on,  $\Delta X$  and  $\Delta Y$  are set to the differences in the stimulus values and the measurement values between the reference marker and the active marker, respectively. (No query)

### Parameters

Sub-block	Description
CALCulate{1-5}	Specifies the trace number (1 to 5).

Related commands **CALC{1-5}:MARK:APE:EXC:X** command on page 307

**CALC{1-5}:MARK:APE:EXC:Y** command on page 308

Front Panel Equivalents **Marker - Function...** - Search Def & Range Menu - Marker to Peak Delta

## CALC{1-5}:MARK:APE:EXC:X

**Format**                   CALCulate{1-5}:MARKer:APeak:EXCursion:X <numeric>  
 CALCulate{1-5}:MARKer:APeak:EXCursion:X?

**Description**           Sets the  $\Delta X$  value to define the peak in the marker peak search function.  
 In addition, use the **CALC{1-5}:MARK:APE:EXC:Y** command to set the  $\Delta Y$  value.

**Parameters**

Sub-block	Description
CALCulate{1-5}	Specifies the trace number (1 to 5).

<numeric>	
Description	$\Delta X$ value
Data type	Floating point
Range	0 to 3E9                   Frequency sweep 0 to 41                    Oscillator power level sweep 0 to 502E-3               Oscillator voltage level sweep 0 to 10E-3                Oscillator current level sweep 0 to 80                    dc bias voltage sweep 0 to 100E-3               dc bias current sweep
Default	10E6
Unit	Variable depending on the sweep parameter.

If the specified parameter is outside the range, the minimum (if the lower limit of the range is exceeded) or maximum value (if the upper limit is exceeded) will be assumed.

**Query response**       {numeric}<newline><^END>

**Related commands**   **CALC{1-5}:MARK:APE:EXC:Y** command on page 308  
**CALC{1-5}:MARK:APE:SET** command on page 306

**Front Panel Equivalents**   **Marker - Function...** - Search Def & Range Menu - Peak Delta X

## **CALC{1-5}:MARK:APE:EXC:Y**

**Format**                   CALCulate{1-5}:MARKer:APEak:EXCursion:Y <numeric>  
 CALCulate{1-5}:MARKer:APEak:EXCursion:Y?

**Description**           Sets the  $\Delta Y$  value to define the peak in the marker peak search function.  
 In addition, use the **CALC{1-5}:MARK:APE:EXC:X** command to set the  $\Delta X$  value.

**Parameters**

<b>Sub-block</b>	<b>Description</b>
CALCulate{1-5}	Specifies the trace number (1 to 5).

	<b>&lt;numeric&gt;</b>
Description	$\Delta Y$ value
Data type	Floating point
Range	0 to 100E6
Default	1
Unit	Variable depending on the measurement parameter.

If the specified parameter is outside the range, the minimum (if the lower limit of the range is exceeded) or maximum value (if the upper limit is exceeded) will be assumed.

**Query response**       {numeric}<newline><^END>

**Related commands**   **CALC{1-5}:MARK:APE:EXC:X** command on page 307  
**CALC{1-5}:MARK:APE:SET** command on page 306

**Front Panel  
 Equivalents**           **Marker - Function...** - Search Def & Range Menu - Peak Delta Y



## CALC:MARK:COUP

**Format**                   CALCulate:MARKer:COUPle {ON|OFF|1|0}  
 CALCulate:MARKer:COUPle?

**Description**           As the marker movement setting, selects either the mode in which the markers on all traces are coupled when moved (coupled marker mode) or the mode in which the markers on the differernt traces are moved separately (uncoupled marker mode).

If the markers on other traces are at different positions than that of the marker on the active trace, they are moved when the mode is changed from the uncoupled marker mode to the coupled marker mode.

**Parameters**

	Description
ON or 1 (Default)	Specifies the coupled marker mode.
OFF or 0	Specifies the uncoupled marker mode.

**Query response**       {1|0}<newline><^END>

**Front Panel  
 Equivalents**           **Marker - Marker...** - More - Coupled Marker: [On/Off]

## CALC{1-5}:MARK:DISC

**Format**                   CALCulate{1-5}:MARKer:DISCrete {ON|OFF|1|0}  
 CALCulate{1-5}:MARKer:DISCrete?

**Description**           Switches between the continuous marker mode (marker movable throughout the range defined by the measurement points) and the discrete marker mode (marker movable only to the measurement points).

**Parameters**

Sub-block	Description
CALCulate{1-5}	Specifies the trace number (1 to 5).

	Description
ON or 1	Specifies the discrete marker mode.
OFF or 0 (Default)	Specifies the continuous marker mode.

**Query response**       {1|0}<newline><^END>

**Front Panel  
 Equivalents**           **Marker - Marker...** - More - Marker: [Continuous/Discrete]

## CALC{4-5}:MARK:FORM

**Format**           CALCulate{4-5}:MARKer:FORMat  
 {REALIMAG|LINMAGPHASE|LOGMAGPHASE|RX|GB|SWRPHASE}  
 CALCulate{4-5}:MARKer:FORMat?

**Description**       Specifies the format for reading the marker position measurement value when the complex trace is displayed.

In addition, use the **CALC{1-5}:MARK{1-8}:Y?** command or the **CALC{1-5}:MARK:REF:Y** command to read the measurement value at the marker position.

**Parameters**

Sub-block	Description
CALCulate{4-5}	Specifies the trace number (4 to 5).

	Description
REALIMAG	Real part and imaginary part of the complex number
LINMAGPHASE (Default)	Linear amplitude and phase
LOGMAGPHASE	Logarithmic amplitude and phase
RX	Complex impedance
GB	Complex admittance
SWRPHASE	SWR (Standing Wave Ratio) and phase

**Query response**    {REALIMAG|LINMAGPHASE|LOGMAGPHASE|RX|GB|SWRPHASE}<newline><<^E  
 ND>

**Related commands** **CALC{1-5}:MARK{1-8}:Y?** command on page 339  
**CALC{1-5}:MARK:REF:Y** command on page 335

**Front Panel  
 Equivalents**       **Marker - Fctn More...** - Smith/Polar

## CALC{1-5}:MARK:FUNC

**Format**           CALCulate{1-5}:MARKer:FUNCTion[:SElect]  
 {MAXimum|MINimum|PPEak|NPEak|TARget}  
 CALCulate{1-5}:MARKer:FUNCTion[:SElect]?

**Description**       Specifies the marker search function. Executing this command only selects the search function but does not perform the marker search. To execute the marker search, it is necessary to also set on the search tracking function by executing the **CALC{1-5}:MARK:FUNC:EXEC** command or the **CALC{1-5}:MARK:FUNC:TRAC** command.

**Parameters**

Sub-block	Description
CALCulate{1-5}	Specifies the trace number (1 to 5).

	Description
MAXimum (Default)	Specifies the maximum search.
MINimum	Specifies the minimum search.
PPEak	Specifies the positive peak search.
NPEak	Specifies the negative peak search.
TARget	Specifies the target search.

**Query response**   {MAX|MIN|PPE|NPE|TAR}<newline><^END>

**Related commands** **CALC{1-5}:MARK:FUNC:EXEC** command on page 321  
**CALC{1-5}:MARK:FUNC:TRAC** command on page 325

**Front Panel Equivalents**   **Marker - Function...** - Search Type

## **CALC{1-5}:MARK:FUNC:DOM**

**Format**                    CALCulate{1-5}:MARKer:FUNCtion:DOMain[:STATe] {ON|OFF|1|0}  
                            CALCulate{1-5}:MARKer:FUNCtion:DOMain[:STATe]?

**Description**            Turns on/off the partial search function of the marker search function.  
  
                            In addition, use the **CALC{1-5}:MARK:FUNC:DOM:STAR** command and the  
                            **CALC{1-5}:MARK:FUNC:DOM:STOP** command or the  
                            **CALC{1-5}:MARK:FUNC:DOM:SPAN** command to set the partial search range line.

**Parameters**

<b>Sub-block</b>	<b>Description</b>
CALCulate{1-5}	Specifies the trace number (1 to 5).

	<b>Description</b>
ON or 1	Turns on the partial search function.
OFF or 0 (Default)	Turns off the partial search function.

**Query response**        {1|0}<newline><^END>

**Related commands**    **CALC{1-5}:MARK:FUNC:DOM:STAR** command on page 320  
                            **CALC{1-5}:MARK:FUNC:DOM:STOP** command on page 320  
                            **CALC{1-5}:MARK:FUNC:DOM:SPAN** command on page 319

**Front Panel**            **Marker - Function...** - Search Def & Range Menu - Partial Search: [On/Off]  
**Equivalents**

## CALC{1-5}:MARK{1-8}:FUNC:DOM:LIM

**Format**                   CALCulate{1-5}:MARKer{1-8}:FUNCTion:DOMain:LIMit[:STATe] {ON|OFF|1|0}  
 CALCulate{1-5}:MARKer{1-8}:FUNCTion:DOMain:LIMit[:STATe]?

**Description**           Selects whether to set the specified marker as the test marker when using the limit test function.

**Parameters**

Sub-block	Description
CALCulate{1-5}	Specifies the trace number (1 to 5).
MARKer{1-8}	Specifies the marker number (1 to 8).

	Description
ON or 1	Sets the specified marker as the test marker.
OFF or 0 (Default)	Does not set the specified marker as the test marker.

**Query response**       {1|0}<newline><^END>

**Related commands**   **CALC{1-5}:MARK:REF:FUNC:DOM:LIM** command on page 329

**Front Panel  
 Equivalents**           **Marker - Limit...** - Test Marker: [On/Off]

## **CALC{1-5}:MARK:FUNC:DOM:LIM:ALL**

**Format**                    CALCulate{1-5}:MARKer:FUNCTion:DOMain:LIMit:ALL[:STATe] {ON|OFF}|1|0}  
                            CALCulate{1-5}:MARKer:FUNCTion:DOMain:LIMit:ALL[:STATe]?

**Description**            Turns on/off the marker limit test function.

**Parameters**

<b>Sub-block</b>	<b>Description</b>
CALCulate{1-5}	Specifies the trace number (1 to 5).

	<b>Description</b>
ON or 1	Turns on the marker limit test function.
OFF or 0 (Default)	Turns off the marker limit test function.

**Query response**        {1|0}<newline><^END>

**Related commands**    **CALC{1-5}:MARK{1-8}:FUNC:DOM:LIM** command on page 313  
                            **CALC{1-5}:MARK:REF:FUNC:DOM:LIM** command on page 329

**Front Panel**            **Marker - Limit...** - Limit Test: [On/Off]  
**Equivalents**

## CALC{1-5}:MARK:FUNC:DOM:LIM:ALL:RES?

**Format**                   CALCulate{1-5}:MARKer:FUNCtion:DOMain:LIMit:ALL:RESult?

**Description**           Returns the limit test result (logical conjunction of all test results of every test marker operated by AND) at all test marker positions. (Query only)

**Parameters**

Sub-block	Description
CALCulate{1-5}	Specifies the trace number (1 to 5).

**Query response**       {PASS|FAIL|NONE}<newline><^END>

	Description
PASS	Passed
FAIL	Failed
NONE	No limit test is executed.

**Related commands**   **CALC{1-5}:MARK{1-8}:FUNC:DOM:LIM:RES?** command on page 317

**CALC{1-5}:MARK:REF:FUNC:DOM:LIM:RES?** command on page 331

**Front Panel  
Equivalents**           Unavailable.

## **CALC{1-5}:MARK{1-8}:FUNC:DOM:LIM:LOW**

**Format**                   CALCulate{1-5}:MARKer{1-8}:FUNCTion:DOMain:LIMit:LOWer <numeric>  
 CALCulate{1-5}:MARKer{1-8}:FUNCTion:DOMain:LIMit:LOWer?

**Description**           Sets the lower test limit value at the specified marker position when using the limit test function.

In addition, use the **CALC{1-5}:MARK{1-8}:FUNC:DOM:LIM:UP** command to set the upper test limit value.

**Parameters**

<b>Sub-block</b>	<b>Description</b>
CALCulate{1-5}	Specifies the trace number (1 to 5).
MARKer{1-8}	Specifies the marker number (1 to 8).

	<b>&lt;numeric&gt;</b>
Description	Lower test limit value
Data type	Floating point
Range	-1E12 to 1E12
Default	0
Unit	Variable depending on the measurement parameter.

**Query response**       {numeric}<newline><^END>

**Related commands**   **CALC{1-5}:MARK{1-8}:FUNC:DOM:LIM:UP** command on page 318

**Front Panel  
 Equivalents**           **Marker - Limit...** - Lower



## CALC{1-5}:MARK{1-8}:FUNC:DOM:LIM:RES?

**Format**                    CALCulate{1-5}:MARKer{1-8}:FUNCtion:DOMain:LIMit:RESult?

**Description**           Returns the limit test result at the specified marker position. (Query only)

**Parameters**

Sub-block	Description
CALCulate{1-5}	Specifies the trace number (1 to 5).
MARKer{1-8}	Specifies the marker number (1 to 8).

**Query response**       {PASS|FAIL|NONE}<newline><^END>

	Description
PASS	Passed
FAIL	Failed
NONE	No limit test is executed.

**Related commands**   **CALC{1-5}:MARK:REF:FUNC:DOM:LIM:RES?** command on page 331  
**CALC{1-5}:MARK:FUNC:DOM:LIM:ALL:RES?** command on page 315

**Front Panel  
Equivalents**            Unavailable.

**CALC{1-5}:MARK{1-8}:FUNC:DOM:LIM:UP**

**Format**                    CALCulate{1-5}:MARKer{1-8}:FUNCTion:DOMain:LIMit:UPper <numeric>  
 CALCulate{1-5}:MARKer{1-8}:FUNCTion:DOMain:LIMit:UPper?

**Description**            Sets the upper test limit value at the specified marker position when using the limit test function.  
 In addition, use the **CALC{1-5}:MARK{1-8}:FUNC:DOM:LIM:LOW** command to set the lower test limit value.

**Parameters**

Sub-block	Description
CALCulate{1-5}	Specifies the trace number (1 to 5).
MARKer{1-8}	Specifies the marker number (1 to 8).

	<numeric>
Description	Upper test limit value
Data type	Floating point
Range	-1E12 to 1E12
Default	0
Unit	Variable depending on the sweep parameter.

**Query response**        {numeric}<newline><^END>

**Related commands**    **CALC{1-5}:MARK{1-8}:FUNC:DOM:LIM:LOW** command on page 316

**Front Panel**            **Marker - Limit... - Upper**  
**Equivalents**

## CALC{1-5}:MARK:FUNC:DOM:SPAN

**Format**                   CALCulate{1-5}:MARKer:FUNCtion:DOMain:SPAN  
 CALCulate{1-5}:MARKer:FUNCtion:DOMain:SPAN?

**Description**           If the reference marker is set to on, sets the marker partial search range using the span of the reference marker and the active marker. The span value in the partial search range is read when executing the command by query.

**Parameters**

Sub-block	Description
CALCulate{1-5}	Specifies the trace number (1 to 5).

**Query response**       {numeric}<newline><^END>  
 It is read in the floating-point value.

**Related commands**   **CALC{1-5}:MARK:FUNC:DOM** command on page 312

**Front Panel  
 Equivalents**           **Marker - Function...** - Search Def & Range Menu - Mkr Delta to Search Range

## **CALC{1-5}:MARK:FUNC:DOM:STAR**

**Format**                   CALCulate{1-5}:MARKer:FUNCtion:DOMain:STARt  
CALCulate{1-5}:MARKer:FUNCtion:DOMain:STARt?

**Description**           Sets the stimulus value of the active marker position on the left range line of the marker partial search range. This left range line is read when executing the command by query.  
In addition, use the **CALC{1-5}:MARK:FUNC:DOM:STOP** command to set the right range line.

**Parameters**

Sub-block	Description
CALCulate{1-5}	Specifies the trace number (1 to 5).

**Query response**       {numeric}<newline><^END>

**Related commands**   **CALC{1-5}:MARK:FUNC:DOM** command on page 312  
**CALC{1-5}:MARK:FUNC:DOM:STOP** command on page 320

**Front Panel  
Equivalent**           **Marker - Function...** - Search Def & Range Menu - Marker to left Range

## **CALC{1-5}:MARK:FUNC:DOM:STOP**

**Format**                   CALCulate{1-5}:MARKer:FUNCtion:DOMain:STOP  
CALCulate{1-5}:MARKer:FUNCtion:DOMain:STOP?

**Description**           Sets the stimulus value of the active marker position on the right range line of the marker partial search range. This right range line is read when executing the command by query.  
In addition, use the **CALC{1-5}:MARK:FUNC:DOM:STAR** command to set the left range line.

**Parameters**

Sub-block	Description
CALCulate{1-5}	Specifies the trace number (1 to 5).

**Query response**       {numeric}<newline><^END>

**Related commands**   **CALC{1-5}:MARK:FUNC:DOM** command on page 312  
**CALC{1-5}:MARK:FUNC:DOM:STAR** command on page 320

**Front Panel  
Equivalent**           **Marker - Function...** - Search Def & Range Menu - Marker to Right Range

## CALC{1-5}:MARK:FUNC:EXEC

**Format**                   CALCulate{1-5}:MARKer:FUNCtion:EXECute  
 [MAXimum|MINimum|PPEak|NPEak|TARget]

**Description**           Executes the marker search only once. (No query)

In addition, set on the search tracking function with the **CALC{1-5}:MARK:FUNC:TRAC** command after selecting the search function with the **CALC{1-5}:MARK:FUNC** command when you want to repeatedly execute the marker search at every sweep.

**Parameters**

Sub-block	Description
CALCulate{1-5}	Specifies the trace number (1 to 5).

	Description
MAXimum	Searches the maximum value.
MINimum	Searches the minimum value.
PPEak	Searches the positive peak.
NPEak	Searches the negative peak.
TARget	Searches the target.

The parameter selection (search function) can be omitted. In this case, the marker search is executed by the search function selected with the **CALC{1-5}:MARK:FUNC** command.

**Related commands**   **CALC{1-5}:MARK:FUNC** command on page 311  
**CALC{1-5}:MARK:FUNC:TRAC** command on page 325

**Front Panel Equivalents**   **Marker - Function...** - Search Type, and  
**Marker - Function...** - Search

## **CALC{1-5}:MARK:FUNC:EXEC:LEFT**

Format CALCulate{1-5}:MARKer:FUNCtion:EXECute:LEFT

Description Searches the peak/target on the left side of the active marker in the marker search function. Before executing this command, it is necessary to set the search objective (positive peak/negative peak/target) with the **CALC{1-5}:MARK:FUNC** command. (No query)

### Parameters

Sub-block	Description
CALCulate{1-5}	Specifies the trace number (1 to 5).

Related commands **CALC{1-5}:MARK:FUNC** command on page 311  
**CALC{1-5}:MARK:FUNC:EXEC:RIGH** command on page 323  
**CALC{1-5}:MARK:FUNC:EXEC:NEXT** command on page 322

Front Panel Equivalents **Marker - Function... - Left**

## **CALC{1-5}:MARK:FUNC:EXEC:NEXT**

Format CALCulate{1-5}:MARKer:FUNCtion:EXECute:NEXT

Description Searches the largest peak next to the most recently searched peak in the marker search function. Before executing this command, it is necessary to set the search objective (positive peak/negative peak) with the **CALC{1-5}:MARK:FUNC** command. (No query)

### Parameters

Sub-block	Description
CALCulate{1-5}	Specifies the trace number (1 to 5).

Related commands **CALC{1-5}:MARK:FUNC** command on page 311  
**CALC{1-5}:MARK:FUNC:EXEC:LEFT** command on page 322  
**CALC{1-5}:MARK:FUNC:EXEC:RIGH** command on page 323

Front Panel Equivalents **Marker - Function... - Next**

## CALC{1-5}:MARK:FUNC:EXEC:RIGH

**Format**                   CALCulate{1-5}:MARKer:FUNCtion:EXECute:RIGHT

**Description**           Searches the peak/target on the right side of the active marker in the marker search function. Before executing this command, it is necessary to set the search objective (positive peak/negative peak/target) with the **CALC{1-5}:MARK:FUNC** command. (No query)

**Parameters**

Sub-block	Description
CALCulate{1-5}	Specifies the trace number (1 to 5).

**Related commands**   **CALC{1-5}:MARK:FUNC** command on page 311  
**CALC{1-5}:MARK:FUNC:EXEC:LEFT** command on page 322  
**CALC{1-5}:MARK:FUNC:EXEC:NEXT** command on page 322

**Front Panel  
Equivalents**           **Marker - Function...** - Right

## CALC{1-5}:MARK:FUNC:TARG

**Format**                   CALCulate{1-5}:MARKer:FUNCtion:TARGet <numeric>  
 CALCulate{1-5}:MARKer:FUNCtion:TARGet?

**Description**           Sets the target value to perform the target search with the **CALC{1-5}:MARK:FUNC** command or the **CALC{1-5}:MARK:FUNC:EXEC** command in the marker search. Use the relative value from the reference marker to set the target value because the set value is used as the relative value from the reference value in the  $\Delta$  mode.

**Parameters**

Sub-block	Description
CALCulate{1-5}	Specifies the trace number (1 to 5).

	<numeric>
Description	Target value
Data type	Floating point
Range	same Y-axis scale range
Default	0
Unit	Variable depending on the measurement parameter.

**Query response**       {numeric}<newline><^END>

**Related commands**   **CALC{1-5}:MARK:FUNC** command on page 311  
**CALC{1-5}:MARK:FUNC:EXEC** command on page 321

**Front Panel**           **Marker - Function...** - Search Def & Range Menu - Target Value  
**Equivalents**



## CALC{1-5}:MARK:FUNC:TRAC

**Format**                   CALCulate{1-5}:MARKer:FUNCtion:TRACking {ON|OFF|1|0}  
 CALCulate{1-5}:MARKer:FUNCtion:TRACking?

**Description**           Turns on/off the marker search tracking function. Setting on the search tracking automatically executes the marker search for the search function selected with the **CALC{1-5}:MARK:FUNC** command for every sweep.

**Parameters**

Sub-block	Description
CALCulate{1-5}	Specifies the trace number (1 to 5).

	Description
ON or 1	Turns on the marker search tracking function.
OFF or 0 (Default)	Turns off the marker search tracking function.

**Query response**       {1|0}<newline><^END>

**Related commands**   **CALC{1-5}:MARK:FUNC** command on page 311

**Front Panel  
 Equivalents**           **Marker - Function...** - Search Track [On/Off]

## **CALC{1-5}:MARK:LIST**

**Format**                   CALCulate{1-5}:MARKer:LIST {ON|OFF|1|0}  
CALCulate{1-5}:MARKer:LIST?

**Description**           Displays the marker list.  
In addition, it is necessary to set the specified trace to the active trace with the **DISP:TRAC{1-5}:SEL** command when you want to display the marker list.

**Parameters**

<b>Sub-block</b>	<b>Description</b>
CALCulate{1-5}	Specifies the trace number (1 to 5).

	<b>Description</b>
ON or 1	Displays the marker list.
OFF or 0 (Default)	Does not display the marker list.

**Query response**       {1|0}<newline><^END>

**Related commands**   **DISP:TRAC{1-5}:SEL** command on page 358

**Front Panel**           **Marker - Fctn More...** - Marker List [On/Off]  
**Equivalents**

## CALC{1-5}:MARK:ON

**Format**                   CALCulate{1-5}:MARKer:ON {DATA|MEMory}  
 CALCulate{1-5}:MARKer:ON?

**Description**           Selects the trace to display the marker.

**Parameters**

Sub-block	Description
CALCulate{1-5}	Specifies the trace number (1 to 5).

	Description
DATA (Default)	Displays the marker on the data trace.
MEMory *1	Displays the marker on the memory trace.

\*1. Can be selected with the **CALC{1-5}:MATH:FUNC** command when the memory trace is displayed on the screen.

**Query response**       {DATA|MEM}<newline><^END>

**Related commands**   **CALC{1-5}:MATH:FUNC** command on page 340

**Front Panel  
 Equivalents**           **Marker - Marker...** - Marker On [Data/Memory]

## CALC{1-5}:MARK:REF

**Format**                   CALCulate{1-5}:MARKer:REFerence[:STATe] {ON|OFF|1|0}  
 CALCulate{1-5}:MARKer:REFerence[:STATe]?

**Description**           Turns on/off the reference marker (marker R). However, only displaying the reference marker does not set on the  $\Delta$  mode for using the reference marker in  $\Delta$  mode. Use the **CALC{1-5}:MARK:REF:TYPE** command to turn on the  $\Delta$  mode.

In addition, use the **CALC{1-5}:MARK{1-8}** command to turn on/off markers 1-8.

Also, use the **CALC{1-5}:MARK:AOFF** command to turn off all of the markers on the specified trace.

**Parameters**

Sub-block	Description
CALCulate{1-5}	Specifies the trace number (1 to 5).
	Description
ON or 1	Turns on the reference marker.
OFF or 0 (Default)	Turns off the reference marker.

**Query response**       {1|0}<newline><^END>

**Related commands**   **CALC{1-5}:MARK:REF:TYPE** command on page 333  
**CALC{1-5}:MARK{1-8}** command on page 304  
**CALC{1-5}:MARK:AOFF** command on page 305

**Front Panel**           **Marker - Marker...** - Select Marker (Specifies the marker R)  
**Equivalents**           **Marker - Marker...** - Selected Marker [On/Off]

## CALC{1-5}:MARK:REF:ACT

**Format**                   CALCulate{1-5}:MARKer:REFerence:ACTivate

**Description**           Sets the reference marker to the active marker. (No query)  
 In addition, use the **CALC{1-5}:MARK{1-8}:ACT** command to set markers 1-8 to the active marker.

**Parameters**

Sub-block	Description
CALCulate{1-5}	Specifies the trace number (1 to 5).

**Related commands**   **CALC{1-5}:MARK{1-8}:ACT** command on page 305

**Front Panel  
 Equivalents**           **Marker - Marker...** - Select Marker (Specifies the marker R)  
 Alternatively, click on the reference marker directly.

## CALC{1-5}:MARK:REF:FUNC:DOM:LIM

**Format**                   CALCulate{1-5}:MARKer:REFerence:FUNCtion:DOMain:LIMit[:STATe]  
 {ON|OFF|1|0}  
 CALCulate{1-5}:MARKer:REFerence:FUNCtion:DOMain:LIMit[:STATe]?

**Description**           Selects whether to set the reference marker as the test marker when using the limit test function.

**Parameters**

Sub-block	Description
CALCulate{1-5}	Specifies the trace number (1 to 5).

	Description
ON or 1	Sets the reference marker as the test marker.
OFF or 0 (Default)	Does not set the reference marker as the test marker.

**Query response**       {1|0}<newline><^END>

**Front Panel  
 Equivalents**           **Marker - Limit...** - Test Marker [On/Off]

**CALC{1-5}:MARK:REF:FUNC:DOM:LIM:LOW**

**Format**                   CALCulate{1-5}:MARKer:REFerence:FUNCTion:DOMain:LIMit:LOWer <numeric>  
 CALCulate{1-5}:MARKer:REFerence:FUNCTion:DOMain:LIMit:LOWer?

**Description**           Sets the lower test limit value at the reference marker position when using the limit test function.  
 In addition, use the **CALC{1-5}:MARK:REF:FUNC:DOM:LIM:UP** command to set the upper test limit value.

**Parameters**

Sub-block	Description
CALCulate{1-5}	Specifies the trace number (1 to 5).
	<b>&lt;numeric&gt;</b>
Description	Lower test limit value
Data type	Floating point
Range	-1E12 to 1E12
Default	0
Unit	Variable depending on the measurement parameter.

**Query response**       {numeric}<newline><^END>

**Related commands**   **CALC{1-5}:MARK:REF:FUNC:DOM:LIM:UP** command on page 332

**Front Panel**           **Marker - Limit...** - Lower  
**Equivalents**

## CALC{1-5}:MARK:REF:FUNC:DOM:LIM:RES?

Format                   CALCulate{1-5}:MARKer:REfERENCE:FUNction:DOMain:LIMit:RESult?

Description           Returns the limit test result at the reference marker position. (Query only)

Parameters

Sub-block	Description
CALCulate{1-5}	Specifies the trace number (1 to 5).

Query response       {PASS|FAIL|NONE}<newline><^END>

	Description
PASS	Passed
FAIL	Failed
NONE	No limit test is executed.

Related commands   **CALC{1-5}:MARK{1-8}:FUNC:DOM:LIM:RES?** command on page 317

**CALC{1-5}:MARK:FUNC:DOM:LIM:ALL:RES?** command on page 315

Front Panel  
Equivalents       Unavailable.

**CALC{1-5}:MARK:REF:FUNC:DOM:LIM:UP**

**Format**                   CALCulate{1-5}:MARKer:REFerence:FUNCTion:DOMain:LIMit:UPper <numeric>  
 CALCulate{1-5}:MARKer:REFerence:FUNCTion:DOMain:LIMit:UPper?

**Description**           Sets the upper test limit value at the reference marker position when using the limit test function.  
 In addition, use the **CALC{1-5}:MARK:REF:FUNC:DOM:LIM:LOW** command to set the lower test limit value.

**Parameters**

Sub-block	Description
CALCulate{1-5}	Specifies the trace number (1 to 5).

	<numeric>
Description	Upper test limit value
Data type	Floating point
Range	-1E12 to 1E12
Default	0
Unit	Variable depending on the measurement parameter.

**Query response**       {numeric}<newline><^END>

**Related commands**   **CALC{1-5}:MARK:REF:FUNC:DOM:LIM:LOW** command on page 330

**Front Panel  
 Equivalents**         **Marker - Limit... - Upper**



## CALC{1-5}:MARK:REF:TYPE

**Format**                   CALCulate{1-5}:MARKer:REFerence:TYPE {OFF|DELTA|FIXDELTA}  
 CALCulate{1-5}:MARKer:REFerence:TYPE?

**Description**           Selects the type of reference marker (marker R).

**Parameters**

Sub-block	Description
CALCulate{1-5}	Specifies the trace number (1 to 5).

	Description
OFF (Default)	Sets the $\Delta$ mode to off.
DELTA	Sets the $\Delta$ mode to on. At this time, the reference marker is fixed at the position of the current stimulus value. The reference marker moves in accordance with the measurement value variation of the specified stimulus value during the measurement.
FIXDELTA	Sets the $\Delta$ mode to on. At this time, the reference marker is fixed at the position of the current stimulus value and measurement value. The reference marker is fixed during the measurement regardless of the measurement value variation.

**Query response**       {OFF|DELTA|FIXDELTA}<newline><^END>

**Front Panel  
 Equivalents**           **Marker - Marker...** - Delta Marker Menu - Delta Mode

## CALC{1-5}:MARK:REF:X

**Format**                   CALCulate{1-5}:MARKer:REFerence:X <numeric>  
 CALCulate{1-5}:MARKer:REFerence:X?

**Description**           Moves the reference marker (marker R) to the position of the stimulus value specified on the trace. The stimulus value at the reference marker position is read when executing the command by query.

In addition, use the **CALC{1-5}:MARK:REF:Y** command to read the measurement value at the reference marker position.

**Parameters**

Sub-block	Description
CALCulate{1-5}	Specifies the trace number (1 to 5).

	<numeric>
Description	Sets the stimulus value (or sets the measurement point, if the stimulus range is set to zero span and marker x-axis unit is set to time) at the marker position
Data type	Floating point
Range	Variable depending on the marker x-axis unit and sweep parameter.
Default	Variable depending on the marker x-axis unit and sweep parameter.
Unit	Variable depending on the marker x-axis unit and sweep parameter.

If the specified parameter is outside the range, the minimum (if the lower limit of the range is exceeded) or maximum value (if the upper limit is exceeded) will be assumed.

**Query response**       {numeric}<newline><^END>

**Related commands**   **CALC{1-5}:MARK:REF:Y** command on page 335

**Front Panel**           **Marker - Marker...** - Select Marker (Specifies marker R)  
**Equivalents**           **Marker - Marker...** - Stimulus

## CALC{1-5}:MARK:REF:Y

**Format**           CALCulate{1-5}:MARKer:REFerence:Y <numeric 1>,<numeric 2>  
 CALCulate{1-5}:MARKer:REFerence:Y?

**Description**       Moves the reference marker (marker R) to the specified measurement value when the  $\Delta$  mode is set to fixed  $\Delta$ . In addition, use the **CALC{1-5}:MARK:REF:X** command to move the reference marker position to the specified stimulus value.

**Parameters**       • With scalar trace:

Sub-block	Description
CALCulate{1-3}	Specifies the trace number (1 to 3).

	<numeric 1>	<numeric 2>
Description	Measurement value in the real number type	Always 0
Data type	Floating point	
Range	-1E12 to 1E12	
Default	Variable depending on the sweep parameter.	0
Unit		None

• With complex trace:

Sub-block	Description
CALCulate{4-5}	Specifies the trace number (4 to 5).

	<numeric 1>	<numeric 2>
Description	Real part of measurement value (complex type)	Imaginary part of measurement value (complex type)
Data type	Floating point	
Range	-1E12 to 1E12	
Default	Variable depending on the sweep parameter.	
Unit		

**Query response**   {numeric 1}, {numeric 2}<newline><^END>

**Related commands** **CALC{1-5}:MARK:REF:TYPE** command on page 333  
**CALC{1-5}:MARK{1-8}:X** command on page 338

**Front Panel Equivalents**   **Marker - Marker...** - Delta Marker Menu - Delta Value|Delta Aux Value

## CALC{1-5}:MARK:SET

**Format**                   CALCulate{1-5}:MARKer:SET  
 {CENTer|DELTASpan|START|STOP|REFerence|OFFSet}

**Description**           Performs the E4991A's settings by using the stimulus/measurement value at the active marker positions. (No query)

**Parameters**

Sub-block	Description
CALCulate{1-5}	Specifies the trace number (1 to 5).

	Description
CENTer	Sets the stimulus value at the active marker position to the center value in the sweep range.
DELTASpan <sup>*1</sup>	Sets the area where the active marker and reference marker are placed to the span value in the sweep range.
START	Sets the stimulus value at the active marker position to the start value in the sweep range.
STOP	Sets the stimulus value at the active marker position to the stop value in the sweep range.
REFerence <sup>*2</sup>	Sets the measurement value at the active marker position to the reference value on the Y-axis.
OFFSet <sup>*3</sup>	Sets the measurement value at the active marker position to the offset value to be subtracted from the trace data.

- \*1. Can be set when the Δ mode is set to on.
- \*2. Can be set when the display format is the linear Y-axis format or the complex plane format.
- \*3. Can be set for the scalar trace.

**Front Panel Equivalents**           **Marker - To...** - Center|DeltaToSpan|Start|Stop|Reference|Offset

## CALC{1-5}:MARK:UNIT

**Format**                   CALCulate{1-5}:MARKer:UNIT {SPARameter|TIME|IOMega}  
 CALCulate{1-5}:MARKer:UNIT?

**Description**             Specifies the display method of the marker value on the X-axis.

**Parameters**

Sub-block	Description
CALCulate{1-5}	Specifies the trace number (1 to 5).

	Description
SPARameter (Default)	Specifies the display for sweep parameter.
TIME	Specifies the display for time (required sweep time from start to end).
IOMega <sup>*1</sup>	Specifies the display for relaxation time ( $1/2\pi f$ , f: measurement frequency).

\*1. Can be set when the sweep parameter is the frequency sweep.

**Query response**         {SPAR|TIME|IOM}<newline><^END>

**Front Panel  
Equivalents**             **Marker - Fctn More...** - Marker X Axis

## CALC{1-5}:MARK{1-8}:X

**Format**           CALCulate{1-5}:MARKer{1-8}:X <numeric>  
 CALCulate{1-5}:MARKer{1-8}:X?

**Description**       Moves the marker to the stimulus value specified on the trace. The stimulus value at the marker position is read when executing the command by query.

In addition, when the  $\Delta$  mode is set to on and this command is executed by query, the stimulus value at the marker position is read in the form of a relative value to the reference marker

**Parameters**

Sub-block	Description
CALCulate{1-5}	Specifies the trace number (1 to 5).
MARKer{1-8}	Specifies the marker number (1 to 8)

	<numeric>
Description	Sets the stimulus value (or sets measurement point if the stimulus range is set to zero span and marker x-axis unit is set to time) at the marker position.
Data type	Floating point
Range	Variable depending on the marker x-axis unit and sweep parameter.
Default	Variable depending on the marker x-axis unit and sweep parameter.
Unit	Variable depending on the marker x-axis unit and sweep parameter.

If the specified parameter is outside the range, the minimum (if the lower limit of the range is exceeded) or maximum value (if the upper limit is exceeded) will be assumed.

**Query response**    {numeric}<newline><^END>

**Related commands** **CALC{1-5}:MARK{1-8}:Y?** command on page 339

**Front Panel**       **Marker - Marker...** - Select Marker (Specifies the marker 1-8)  
**Equivalents**       **Marker - Marker...** - Stimulus

## CALC{1-5}:MARK{1-8}:Y?

**Format**                   CALCulate{1-5}:MARKer{1-8}:Y?

**Description**           Reads the measurement value at the marker position. When the  $\Delta$  mode is set to on and this command is executed, the measurement value at the marker position is read in the form of a relative value to the reference marker. (Query only)

**Parameters**

Sub-block	Description
CALCulate{1-5}	Specifies the trace number (1 to 5).
MARKer{1-8}	Specifies the marker number (1 to 8).

**Query response**       {numeric 1}, {numeric 2}<newline><^END>

- With complex trace:

	{numeric 1}	{numeric 2}
Description	Real part of measurement value (complex type)	Imaginary part of measurement value (complex type)
Data type	Floating point	

- With scalar trace:

	{numeric 1}	{numeric 2}
Description	Measurement value of real number type	0 is always read.
Data type	Floating point	

**Related commands**   **CALC{1-5}:MARK{1-8}:X** command on page 338

**Front Panel  
 Equivalents**           Unavailable.

## CALC{1-5}:MATH:FUNC

**Format**                    CALCulate{1-5}:MATH:FUNCtion {DATA|AND|MEM|DMNM|PER|DDVM}  
 CALCulate{1-5}:MATH:FUNCtion?

**Description**            Selects the trace to be displayed.

**Parameters**

Sub-block	Description
CALCulate{1-5}	Specifies the trace number (1 to 5).

	Description
DATA (Default)	Displays the data trace.
AND	Displays both the data trace and the memory trace.
MEM	Displays the memory trace.
DMNM	Displays the data trace. The data trace content is the operation result of "DATA - MEM".
PER <sup>*1</sup>	Displays the data trace. The data trace content is the operation result of "(DATA - MEM) / MEM × 100(%)".
DDVM <sup>*2</sup>	Displays the data trace. The data trace content is the operation result of "DATA / MEM".

\*1. Can be selected for the scalar trace (trace number 1, 2, or 3)

\*2. Can be selected for the complex trace (trace number 4 or 5)

The memory trace can be displayed when the data trace is copied to the memory trace using the **CALC{1-5}:MATH:MEM** command or the frequency characteristic is simulated in the equivalent circuit analysis using the **CALC{1-5}:EPAR:SIM** command.

**Query response**        {DATA|AND|MEM|DMNM|PER|DDVM}<newline><^END>

**Related commands**    **CALC{1-5}:MATH:MEM** command on page 341

**CALC{1-5}:EPAR:SIM** command on page 297

**Front Panel**            **Display - Display...** - Define Trace  
**Equivalents**



## CALC{1-5}:MATH:MEM

Format           CALCulate{1-5}:MATH:MEMorize

Description      Copies the data trace to the memory trace. (No query)

In addition, use the **CALC{1-5}:MATH:FUNC** command to display the memory trace.  
 And, use the **CALC{1-5}:DATA?** command to read the memory trace content.

Parameters

Sub-block	Description
CALCulate{1-5}	Specifies the trace number (1 to 5).

Related commands   **CALC{1-5}:MATH:FUNC** command on page 340

**CALC{1-5}:DATA?** command on page 293

Front Panel  
 Equivalents       **Display - Display...** - Copy Data -> Memory

## CALC{1-3}:MATH:OFFS

**Format**                   CALCulate{1-3}:MATH:OFFSet <numeric>  
 CALCulate{1-3}:MATH:OFFSet?

**Description**           Sets the offset value to be subtracted from the data trace for the scalar trace.

**Parameters**

Sub-block	Description
CALCulate{1-3}	Specifies the trace number (1 to 3).

	<numeric>
Description	Offset value
Data type	Floating point
Range	same Y-axis scale range
Default	0
Unit	Variable depending on the measurement parameter.

**Query response**       {numeric}<newline><^END>

**Front Panel**           **Display - Display...** - Math Offset  
**Equivalents**

## CALC{1-5}:MST

**Format**                   CALCulate {1-5}[:EVALuate]:MSTatistics[:STATe] {ON|OFF|1|0}  
 CALCulate {1-5}[:EVALuate]:MSTatistics[:STATe]?

**Description**           Displays the statistical analysis results. Statistical values (average value, standard deviation, difference between maximum value and minimum value) in the marker partial search range are calculated and displayed at every sweep completion. When the marker display is set to off, no statistical analysis results are displayed. In addition, when the marker partial search range is not set on with the **CALC{1-5}:MARK:FUNC:DOM** command, the statistical values in all sweep ranges are calculated and displayed.

It is necessary to set markers on with the **CALC{1-5}:MARK{1-8}** command or the **CALC{1-5}:MARK:REF** command when you want to display the statistical analysis results.

In addition, use the **CALC{1-5}:MST:DATA?** command to read the statistical value.

**Parameters**

Sub-block	Description
CALCulate {1-5}	Specifies the trace number (1 to 5).

	Description
ON or 1	Displays the statistical analysis result.
OFF or 0 (Default)	Does not display the statistical analysis result.

**Query response**       {1|0}<newline><^END>

**Related commands**   **CALC{1-5}:MST:DATA?** command on page 344  
**CALC{1-5}:MARK{1-8}** command on page 304  
**CALC{1-5}:MARK:REF** command on page 328  
**CALC{1-5}:MARK:FUNC:DOM** command on page 312

**Front Panel  
 Equivalents**           **Marker - Fctn More...** - Statistics [On/Off]

## **CALC{1-5}:MST:DATA?**

**Format**                   CALCulate{1-5}[:EVALuate]:MSTatistics:DATA? {MEAN|SDEV|PEAK}

**Description**            Reads the statistical analysis result. (Query only)

In addition, use the **CALC{1-5}:MST** command to turn on/off the statistical analysis function.

**Parameters**

<b>Sub-block</b>	<b>Description</b>
CALCulate{1-5}	Specifies the trace number (1 to 5).

	<b>Description</b>
MEAN	Specifies the average value.
SDEV	Specifies the standard deviation.
PEAK	Specifies the difference between maximum value and minimum (peak-to-peak) value.

**Query response**        {numeric}<newline><^END>

It is read in the floating-point value.

**Related commands**    **CALC{1-5}:MST** command on page 343

**Front Panel  
Equivalents**            Unavailable.

## DATA:CAD{1-8}?

**Format** DATA[:DATA]:CAD{1-8}?

**Description** Reads the calibration data array. (Query only)

**NOTE** This command can be used to read a calibration data array that is measured with the calibration data measurement points of “User-defined frequency points” or “User-defined power points.”

**Parameters** The calibration data arrays include a total of eight standard measurement data (two measurements each) of Open/Short/Load/Low-loss capacitor. CAD1 to CAD8 correspond to these data arrays.

Sub-block	Description
CAD1	Specifies the first Open calibration data array.
CAD2	Specifies the first Short calibration data array.
CAD3	Specifies the first Load calibration data array.
CAD4	Specifies the first Low-loss capacitor calibration data array.
CAD5	Specifies the second Open calibration data array.
CAD6	Specifies the second Short calibration data array.
CAD7	Specifies the second Load calibration data array.
CAD8	Specifies the second Low-loss capacitor calibration data array.

**Query response** {numeric 1}, {numeric 2},..., {numeric N × 2 - 1}, {numeric N × 2}<newline><^END>

	Description
{numeric n × 2 - 1}	Real part of data (complex type) at the n-th measurement point
{numeric n × 2}	Imaginary part of data (complex type) at the n-th measurement point

The data consist of the real and imaginary parts of a complex number. n indicates an integer between 1 and N, where N is the number of measurement points.

It is read in the floating-point value.

**Related commands** **DATA:SEGM{1-16}:CAD{1-8}?** command on page 350  
**SENS:CORR1:COLL:FPO** command on page 438  
**FORM:DATA** command on page 374

**Front Panel  
 Equivalent** Unavailable.

## DATA:CCO{1-6}

- Format** DATA[:DATA]:CCO{1-6} <numeric 1>,<numeric 2>,...,<numeric N×2-1>,<numeric N×2>  
 DATA[:DATA]:CCO{1-6}?
- Description** Sets the calibration coefficient array for calibration. The calibration coefficient array is read during execution by query.
- Parameters** There are a total of six calibration coefficient arrays for each coefficient of A1, B1, C1, A2, B2, and C2. CC01 to CC06 correspond to these data arrays.

Sub-block	Description
CC01	Specifies the calibration coefficient A1 array.
CC02	Specifies the calibration coefficient B1 array.
CC03	Specifies the calibration coefficient C1 array.
CC04	Specifies the calibration coefficient A2 array.
CC05	Specifies the calibration coefficient B2 array.
CC06	Specifies the calibration coefficient C2 array.

	Description
<numeric n × 2 - 1>	Real part of data (complex type) at the n-th measurement point
<numeric n × 2>	Imaginary part of data (complex type) at the n-th measurement point

The data consist of the real and imaginary parts of a complex number. n indicates an integer between 1 and N, where N is the number of measurement points.

It is read in the floating-point value.

- Query response** {numeric 1}, {numeric 2},..., {numeric N × 2 - 1}, {numeric N × 2}<newline><^END>
- Related commands** **DATA:SEGM{1-16}:CCO{1-6}** command on page 351  
**FORM:DATA** command on page 374
- Front Panel Equivalents** Unavailable.

## DATA:CMD{1-2}?

Format DATA[:DATA]:CMD{1-2}?

Description Reads the fixture compensation data array. (Query only)

**NOTE** This command can be used to read a fixture compensation data array measured with the fixture compensation data measurement points of “User-defined frequency points” or “User-defined power points.”

Parameters The fixture compensation data arrays include two standard measurement data of Open/Short. CMD1 and CMD2 correspond to these data arrays.

Sub-block	Description
CMD1	Specifies the Open compensation data array.
CMD2	Specifies the Short compensation data array.

Query response {numeric 1}, {numeric 2},..., {numeric N × 2 - 1}, {numeric N × 2}<newline><^END>

	Description
{numeric n × 2 - 1}	Real part of data (complex type) at the n-th measurement point
{numeric n × 2}	Imaginary part of data (complex type) at the n-th measurement point

The data consist of the real and imaginary parts of a complex number. n indicates an integer between 1 and N, where N is the number of measurement points.

It is read in the floating-point value.

Related commands **DATA:SEGM{1-16}:CMD{1-2}?** command on page 352

**SENS:CORR2:COLL:FPO** command on page 450

**FORM:DATA** command on page 374

Front Panel Equivalents Unavailable.

## DATA: CMP{1-3}

- Format** DATA[:DATA]:CMP{1-3} <numeric 1>,<numeric 2>,...,<numeric N×2-1>,<numeric N×2>  
 DATA[:DATA]:CMP{1-3}?
- Description** Sets the fixture compensation coefficient array. The fixture compensation coefficient array is read when executing the command by query.
- Parameters** There are three fixture compensation coefficient arrays for the coefficients of A, B, and C. CMP1 to CMP3 correspond to these data arrays.

Sub-block	Description
CMP1	Specifies the fixture compensation coefficient A array.
CMP2	Specifies the fixture compensation coefficient B array.
CMP3	Specifies the fixture compensation coefficient C array.

	Description
<numeric n × 2 - 1>	Real part of data (complex type) at the n-th measurement point
<numeric n × 2>	Imaginary part of data (complex type) at the n-th measurement point

The data consist of the real and imaginary parts of a complex number. n indicates an integer between 1 and N, where N is the number of measurement points.

It is read in the floating-point value.

- Query response** {numeric 1}, {numeric 2},..., {numeric N × 2 - 1}, {numeric N × 2}<newline><^END>
- Related commands** **DATA:SEGM{1-16}:CMP{1-3}** command on page 353  
**FORM:DATA** command on page 374
- Front Panel Equivalents** Unavailable.



## DATA:RAW?

Format DATA[:DATA]:RAW?

Description Reads the raw data array. (Query only)

Query response {numeric 1}, {numeric 2},..., {numeric  $N \times 2 - 1$ }, {numeric  $N \times 2$ }<newline><^END>

	Description
{numeric $n \times 2 - 1$ }	Real part of data (complex type) at the n-th measurement point
{numeric $n \times 2$ }	Imaginary part of data (complex type) at the n-th measurement point

The data consist of the real and imaginary parts of a complex number. n indicates an integer between 1 and N, where N is the number of measurement points.

It is read in the floating-point value.

Related commands **FORM:DATA** command on page 374

Front Panel  
 Equivalents Unavailable.

## **DATA:SEGM{1-16}:CAD{1-8}?**

**Format** DATA[:DATA]:SEGMENT{1-16}:CAD{1-8}?

**Description** Reads the calibration data array of the segment sweep. (Query only)

---

**NOTE** This command can be used to read a calibration data array measured with the calibration data measurement points of “User-defined frequency points” or “User-defined power points”

---

**Parameters** The calibration data arrays include a total of eight standard measurement data (two measurements each) of Open/Short/Load/Low-loss capacitor. CAD1 to CAD8 correspond to these data arrays.

<b>Sub-block</b>	<b>Description</b>
SEGMENT{1-16}	Specifies the segment number (1 to 16).

<b>Sub-block</b>	<b>Description</b>
CAD1	Specifies the first Open calibration data array.
CAD2	Specifies the first Short calibration data array.
CAD3	Specifies the first Load calibration data array.
CAD4	Specifies the first Low-loss capacitor calibration data array.
CAD5	Specifies the second Open calibration data array.
CAD6	Specifies the second Short calibration data array.
CAD7	Specifies the second Load calibration data array.
CAD8	Specifies the second Low-loss capacitor calibration data array.

**Query response** {numeric 1}, {numeric 2},..., {numeric N × 2 - 1}, {numeric N × 2}<newline><^END>

	<b>Description</b>
{numeric n × 2 - 1}	Real part of data (complex type) at the n-th measurement point
{numeric n × 2}	Imaginary part of data (complex type) at the n-th measurement point

The data consist of the real and imaginary parts of a complex number. n indicates an integer between 1 and N, where N is the number of measurement points of the specified segment.

It is read in the floating-point value.

**Related commands** **DATA:CAD{1-8}?** command on page 345

**SENS:CORR1:COLL:FPO** command on page 438

**FORM:DATA** command on page 374

Front Panel  
Equivalents

Unavailable.

### **DATA:SEGM{1-16}:CCO{1-6}**

Format

DATA[:DATA]:SEGMent{1-16}:CCO{1-6} <numeric 1>,<numeric 2>,...,<numeric N×2-1>,<numeric N×2>

Description

Sets the calibration coefficient array for calibration of the segment sweep. The calibration coefficient array is read when executing by query.

Parameters

There are a total of six calibration coefficient arrays for the coefficients of A1, B1, C1, A2, B2, and C2. CC01 to CC06 correspond to these data arrays.

Sub-block	Description
SEGMent{1-16}	Specifies the segment number (1 to 16).

Sub-block	Description
CC01	Specifies the calibration coefficient A1 array.
CC02	Specifies the calibration coefficient B1 array.
CC03	Specifies the calibration coefficient C1 array.
CC04	Specifies the calibration coefficient A2 array.
CC05	Specifies the calibration coefficient B2 array.
CC06	Specifies the calibration coefficient C2 array.

	Description
<numeric n × 2 - 1>	Real part of data (complex type) at the n-th measurement point
<numeric n × 2>	Imaginary part of data (complex type) at the n-th measurement point

The data consist of the real and imaginary parts of a complex number. n indicates an integer between 1 and N, where N is the number of measurement points of the specified segment.

It is read in the floating-point value.

Query response

{numeric value 1}, {numeric value 2},..., {numeric value N × 2 - 1}, {numeric value N × 2}<newline><^END>

Related commands

**DATA:CCO{1-6}** command on page 346  
**FORM:DATA** command on page 374

Front Panel  
Equivalents

Unavailable.

## **DATA:SEGM{1-16}:CMD{1-2}?**

**Format** DATA[:DATA]:SEGMENT{1-16}:CMD{1-2}?

**Description** Reads the fixture compensation data array of the segment sweep. (Query only)

**NOTE** This command can be used to read a fixture compensation data array measured with the fixture compensation data measurement points of “User-defined frequency points” or “User-defined power points”

**Parameters** The fixture compensation data arrays include two standard measurement data of Open/Short. CMD1 and CMD2 correspond to these data arrays.

<b>Sub-block</b>	<b>Description</b>
SEGMENT{1-16}	Specifies the segment number (1 to 16).

<b>Sub-block</b>	<b>Description</b>
CMD1	Specifies the Open compensation data array.
CMD2	Specifies the Short compensation data array.

**Query response** {numeric 1}, {numeric 2},..., {numeric N × 2 - 1}, {numeric N × 2}<newline><<^END>

	<b>Description</b>
{numeric n × 2 - 1}	Real part of data (complex type) at the n-th measurement point
{numeric n × 2}	Imaginary part of data (complex type) at the n-th measurement point

The data consist of the real and imaginary parts of a complex number. n indicates an integer between 1 and N, where N is the number of measurement points of the specified segment.

It is read in the floating-point value.

**Related commands** **DATA:CMD{1-2}?** command on page 347  
**SENS:CORR2:COLL:FPO** command on page 450  
**FORM:DATA** command on page 374

**Front Panel  
 Equivalents** Unavailable.

## DATA:SEGM{1-16}:CMP{1-3}

**Format** DATA[:DATA]:SEGMent{1-16}:CMP{1-3} <numeric 1>,<numeric 2>,...,<numeric N×2-1>,<numeric N×2>  
 DATA[:DATA]:SEGMent{1-16}:CMP{1-3}?

**Description** Sets the fixture compensation coefficient array for the segment sweep. The fixture compensation coefficient array is read when executing by query.

**Parameters** There are three fixture compensation coefficient arrays for the coefficients of A, B, and C. CMP1 to CMP3 correspond to these data arrays.

Sub-block	Description
SEGMent{1-16}	Specifies the segment number (1 to 16).

Sub-block	Description
CMP1	Specifies the fixture compensation coefficient A array.
CMP2	Specifies the fixture compensation coefficient B array.
CMP3	Specifies the fixture compensation coefficient C array.

	Description
<numeric n × 2 - 1>	Real part of data (complex type) at the n-th measurement point
<numeric n × 2>	Imaginary part of data (complex type) at the n-th measurement point

The data consist of the real and imaginary parts of a complex number. n indicates an integer between 1 and N, where N is the number of measurement points of the specified segment.

It is read in the floating-point value.

**Query response** {numeric 1}, {numeric 2},..., {numeric N × 2 - 1}, {numeric N × 2}<newline><^END>

**Related commands** **DATA: CMP{1-3}** command on page 348  
**FORM: DATA** command on page 374

**Front Panel Equivalents** Unavailable.

## **DISP:BACK**

Format           DISPlay:BACKlight {ON|OFF|1|0}  
                  DISPlay:BACKlight?

Description       Turns on/off the LCD backlight.

Parameters

	Description
ON or 1 (Default)	Turns on the LCD backlight.
OFF or 0	Turns off the LCD backlight.

Query response    {1|0}<newline><^END>

Front Panel  
Equivalents       Unavailable.

## **DISP:ENAB**

Format           DISPlay:ENABLE {ON|OFF|1|0}  
                  DISPlay:ENABLE?

Description       Sets whether to update the information shown on the screen. No display information is updated when the command is set to off. However, other operations, e.g. measurement of device under test, are normally performed. Furthermore, the CPU power otherwise allocated to update the display is used for parts inside the instrument other than the display.

When the LCD backlight is set to off with the **DISP:BACK** command, the information on the display is still updated even though it is not visible.

Parameters

	Description
ON or 1 (Default)	Updates the information shown on the screen.
OFF or 0	Does not update the information shown on the screen.

Query response    {1|0}<newline><^END>

Related commands **DISP:BACK** command on page 354

Front Panel  
Equivalents       Unavailable.

## DISP:FORM

Format           DISPlay[:WINDow]:FORMat {SPLit|OVERlay}  
 DISPlay[:WINDow]:FORMat?

Description       When displaying plural scalar traces, selects whether to arrange all displayed traces so that they overlap in a single window screen or so that they are divided and displayed in individual window screens.

Parameters

	Description
SPLit	Divides traces to show them in individual window screens.
OVERlay (Default)	Displays all traces in a single window screen.

Query response    {SPL|OVER}<newline><^END>

Front Panel  
 Equivalents       **Display - Display...** - Display Scalar Trace [Overly/Split]

## DISP:TEXT

Format           DISPlay[:WINDow]:TEXT[:STATe] {ON|OFF|1|0}  
 DISPlay[:WINDow]:TEXT[:STATe]?

Description       Switches between text display and measurement display.  
 In addition, use the **DISP:TEXT{1-3}:SET** command to specify the page in the text display.

Parameters

	Description
ON or 1	Shows the text display.
OFF or 0 (Default)	Shows the measurement display.

Related commands **DISP:TEXT{1-3}:SET** command on page 356

Front Panel  
 Equivalents       Click on the part of the “<< “ when changing the display from text display screen to measurement display screen

## DISP:TEXT{1-3}:SET

Format DISPlay[:WINDow]:TEXT{1-3}:SET

Description Displays the text information on the screen. (No query)

Parameters

Sub-block	Description
TEXT1	Specifies the display of segment sweep table.
TEXT2	Specifies the display of setting parameters.
TEXT3	Specifies the display of limit test menu.

Related commands **DISP:TEXT** command on page 355

Front Panel **Stimulus - Sweep Setup...** - Segment Table Menu  
 Equivalents **Display - Display...** - More - Operation Param Menu  
**Marker - Limit...**

## DISP:TRAC{1-5}

Format DISPlay[:WINDow]:TRACe{1-5}[:STATe] {ON|OFF|1|0}

DISPlay[:WINDow]:TRACe{1-5}[:STATe]?

Description Turns on/off the specified trace.

Parameters

Sub-block	Description
TRACe{1-5}	Specifies the trace number (1 to 5)

	Description
ON or 1 (Default: Trace 1,2)	Turns on the trace.
OFF or 0 (Default: Trace 3,4,5)	Turns off the trace.

Query response {1|0}<newline><^END>

Front Panel **Display - Display...** - Num Of Traces  
 Equivalents However, only specifying the trace number cannot set the trace to on.



## DISP:TRAC{1-5}:GRAT:FORM

**Format**           DISPlay[:WINDow]:TRACe{1-5}:GRATicule:FORMat  
 {RECTangle|POLar|SMITH|ADMittance|CPLane}  
 DISPlay[:WINDow]:TRACe{1-5}:GRATicule:FORMat?

**Description**       Selects the trace display format.

**Parameters**       The following display formats can be selected:

- Display format that can be selected for the scalar trace:

Sub-block	Description
TRACe{1-3}	Specifies the trace number (1 to 3)

	Description
RECTangle	Specifies the rectangle format (use the <b>DISP:TRAC{1-3}:Y:SPAC</b> command to set the linear/log Y-axis format for the rectangle format)

- Display format that can be selected for the complex trace:

Sub-block	Description
TRACe{4-5}	Specifies the trace number (4 to 5)

	Description
POLar (Default)	Specifies the polar format
SMITH	Specifies the Smith chart format
ADMittance	Specifies the admittance chart format
CPLane	Specifies the complex plane format

**Query response**    {RECT|POL|SMIT|ADM|CPL}<newline><^END>

**Related commands** **DISP:TRAC{1-3}:Y:SPAC** command on page 371

**Front Panel**       **Meas/Format - Meas/Format...** - Format  
**Equivalents**

## DISP:TRAC{1-3}:REF

Format                   DISPlay[:WINDow]:TRACe{1-3}:REFerence[:STATe] {ON|OFF|1|0}  
 DISPlay[:WINDow]:TRACe{1-3}:REFerence[:STATe]?

Description           Selects whether to display the scale reference line for the linear Y-axis format.

### Parameters

Sub-block	Description
TRACe{1-3}	Specifies the trace number (1 to 3)
	<b>Description</b>
ON or 1 (Default)	Displays the reference line.
OFF or 0	Does not display the reference line.

Query response        {1|0}<newline><^END>

Related commands    **DISP:TRAC{1-3}:Y:RPOS** command on page 370

**DISP:TRAC{1-5}:Y:RLEV** command on page 369

Front Panel  
 Equivalents         **Scale - Scale...** - Reference Line [On/Off]

## DISP:TRAC{1-5}:SEL

Format                   DISPlay[:WINDow]:TRACe{1-5}:SELect

Description           Sets the specified trace to the active trace. (No query)

### Parameters

Sub-block	Description
TRACe{1-5}	Specifies the trace number (1 to 5)

Front Panel  
 Equivalents         **Trace - Scalar{1|2|3}|Complex{4|5}**

## DISP:TRAC{1-5}:TEXT

**Format**                   DISPlay[:WINDow]:TRACe{1-5}:TEXT[:STATe] {ON|OFF|1|0}  
 DISPlay[:WINDow]:TRACe{1-5}:TEXT[:STATe]?

**Description**           Switches between the graph display and list display on the specified trace.

**Parameters**

Sub-block	Description
TRACe{1-5}	Specifies the trace number (1 to 5)

	Description
ON or 1	Specifies the list display.
OFF or 0 (Default)	Specifies the graph display.

**Query response**       {1|0}<newline><^END>

**Related commands**   **DISP:TRAC{1-5}:TEXT:PAGE** command on page 359

**Front Panel  
 Equivalents**           **Display - Display...** - List Values [On/Off]

## DISP:TRAC{1-5}:TEXT:PAGE

**Format**                   DISPlay[:WINDow]:TRACe{1-5}:TEXT:PAGE {UP|DOWN}

**Description**           Scrolls the page when the screen is the list display. This command is ignored when the screen is the graph display. (No query)

**Parameters**

Sub-block	Description
TRACe{1-5}	Specifies the trace number (1 to 5)

	Description
UP	Scrolls the screen display up.
DOWN	Scrolls the screen display down.

**Related commands**   **DISP:TRAC{1-5}:TEXT** command on page 359

**Front Panel  
 Equivalents**           scroll the screen using the scroll bar

**DISP:TRAC{1-5}:TITL**

**DISP:TRAC{1-5}:TITL**

**Format**                   DISPlay[:WINDow]:TRACe{1-5}:TITLe[:STATe] {ON|OFF|1|0}  
DISPlay[:WINDow]:TRACe{1-5}:TITLe[:STATe]?

**Description**           Sets whether to display the trace title.  
In addition, use the **DISP:TRAC{1-5}:TITL:DATA** command to set the string to be displayed in the trace title area.

**Parameters**

Sub-block	Description
TRACe{1-5}	Specifies the trace number (1 to 5)

	Description
ON or 1 (Default)	Displays the title.
OFF or 0	Does not display the title.

**Query response**       {1|0}<newline><^END>

**Related commands**   **DISP:TRAC{1-5}:TITL:DATA** command on page 361

**Front Panel**           **Display - Display... - More - Title - OK**  
**Equivalents**

## DISP:TRAC{1-5}:TITL:DATA

**Format**                   DISPlay[:WINDow]:TRACe{1-5}:TITLe:DATA <string>  
 DISPlay[:WINDow]:TRACe{1-5}:TITLe:DATA?

**Description**           Sets the string to be displayed in the trace title area.  
 In addition, use the **DISP:TRAC{1-5}:TITL** command to display the trace title.

**Parameters**

Sub-block	Description
TRACe{1-5}	Specifies the trace number (1 to 5)
	<b>&lt;string&gt;</b>
Description	Trace title
Default	Blank ("")

**Query response**       {string}<newline><^END>

**Related Commands**   **DISP:TRAC{1-5}:TITL** command on page 360

**Front Panel Equivalents**   **Display - Display... - More - Title**

## DISP:TRAC{4-5}:X:RLEV

**Format**                   DISPlay[:WINDow]:TRACe{4-5}:X[:SCALe]:RLEVel <numeric>  
 DISPlay[:WINDow]:TRACe{4-5}:X[:SCALe]:RLEVel?

**Description**           Sets the reference value (center value) of the X-axis in the complex plane format.  
 In addition, use the **DISP:TRAC{1-5}:Y:RLEV** command to set the reference value of the Y-axis.

**Parameters**

Sub-block	Description
TRACe{4-5}	Specifies the trace number (4 to 5)

	<numeric>
Description	Reference value of X-axis
Data type	Floating point
Range	Variable depending on the measurement parameter.
Default	0
Unit	Variable depending on the measurement parameter.

**Query response**       {numeric}<newline><^END>

**Related commands**   **DISP:TRAC{1-5}:Y:RLEV** command on page 369

**Front Panel**           **Scale - Scale...** - Ref X  
**Equivalents**

## DISP:TRAC{1-5}:X:SPAC

**Format**                   DISPlay[:WINDow]:TRACe{1-5}:X:SPACing {LINear|LOGarithmic|OBASe}  
DISPlay[:WINDow]:TRACe{1-5}:X:SPACing?

**Description**           Selects whether to display the frequency span as the range from the minimum value to the maximum value or to display it divided by segment at the time of segment sweep.

**Parameters**

Sub-block	Description
TRACe{1-5}	Specifies the trace number (1 to 5)

	Description
LINear (Default)	Displays the frequency span as the single span from the minimum value to the maximum value on the linear scale.
LOGarithmic	Displays the frequency span as the single span from the minimum value to the maximum value on the log scale.
OBASe	Displays the frequency span divided in each segment.

**Query response**       {LIN|LOG|OBAS}<newline><^END>

**Front Panel  
Equivalents**           **Stimulus - Sweep Setup...** - Segment Display

## **DISP:TRAC{1-5}:Y:AUTO**

Format                   DISPlay[:WINDow]:TRACe{1-5}:Y[:SCALe]:AUTO

Description           Executes autoscale so that the trace fits the scale. (No query)

Parameters

<b>Sub-block</b>	<b>Description</b>
TRACe{1-5}	Specifies the trace number (1 to 5)

Related commands   **DISP:TRAC:Y:AUTO:ALL** command on page 364

Front Panel  
Equivalents           **Scale - Autoscale**

## **DISP:TRAC:Y:AUTO:ALL**

Format                   DISPlay[:WINDow]:TRACe:Y[:SCALe]:AUTO:ALL

Description           Executes autoscale so that all traces fit the scale. (No query)

Related commands   **DISP:TRAC{1-5}:Y:AUTO** command on page 364

Front Panel  
Equivalents           **Scale - Autoscale All**



## DISP:TRAC{1-3}:Y:BOTT

**Format**                   DISP:TRAC{1-3}:Y[:SCALE]:BOTTom <numeric>  
 DISP:TRAC{1-3}:Y[:SCALE]:BOTTom?

**Description**           Sets the minimum scale value in the Y-axis direction for the scalar trace.  
 In addition, use the **DISP:TRAC{1-3}:Y:TOP** command to set the maximum scale value.

**Parameters**

Sub-block	Description
TRACe{1-3}	Specifies the trace number (1 to 3)

	<numeric>
Description	Minimum scale value in the Y-axis direction
Data type	Floating point
Default	Variable depending on the measurement parameter. <b>In the Linear Y-Axis format:</b> -1 $ \Gamma /\Gamma_x/\Gamma_y$ -200 $\theta_\gamma/\theta_z/\theta_y$ 0 $B/D/Cs/Cp/ \epsilon_r /\epsilon_r'/\epsilon_r''/\tan\delta$ $(\mu)/G/Ls/Lp/ \mu_r /\mu_r'/\mu_r''/Q/R/Rs/Rp/X/Z/ Y $ <b>In the Log Y-Axis format:</b> 1E-9               Cs/Cp 1E-6 $B/D/\tan\delta(\epsilon)/\tan\delta(\mu)/G/ \Gamma /\Gamma_x/\Gamma_y/ Y $ 1E-5               Ls/Lp 1E-4 $\theta_\gamma/\theta_z/\theta_y$ 1E-3               Q 1 $ \epsilon_r /\epsilon_r'/\epsilon_r''/ \mu_r /\mu_r'/\mu_r''/R/Rs/Rp/Z/X$
Unit	Variable depending on the measurement parameter.

**Query response**       {numeric}<newline><^END>

**Related commands**   **DISP:TRAC{1-3}:Y:TOP** command on page 372

**Front Panel**           **Scale - Scale...** - Bottom  
**Equivalents**

## DISP:TRAC{1-5}:Y:FOR

**Format**                   DISPlay[:WINDow]:TRACe{1-5}:Y[:SCALe]:FOR {DATA|MEMory|AND}  
 DISPlay[:WINDow]:TRACe{1-5}:Y[:SCALe]:FOR?

**Description**           Selects the trace to set the scale.

**Parameters**

Sub-block	Description
TRACe{1-5}	Specifies the trace number (1 to 5)

	Description
DATA	Specifies the data trace to set the scale.
MEMory <sup>*1</sup>	Specifies the memory trace to set the scale.
AND <sup>*1</sup>	Specifies both the data trace and memory trace to set the scale.

\*1. Can be set when the memory trace is displayed with the **CALC{1-5}:MATH:FUNC** command.

**Query response**       {DATA|MEM|AND}<newline><^END>

**Related commands**   **CALC{1-5}:MATH:FUNC** command on page 340

**Front Panel**           **Scale - Scale...** - Scale For  
**Equivalents**

## DISP:TRAC{1-5}:Y:FULL

**Format**                   DISPlay[:WINDow]:TRACe{1-5}:Y[:SCALe]:FULL <numeric>  
 DISPlay[:WINDow]:TRACe{1-5}:Y[:SCALe]:FULL?

**Description**           Sets the following parameters for the display trace:

- Full-scale value in the linear Y-axis format
- Scale value in the polar format
- Full-scale value in the complex plane format

**Parameters**

Sub-block	Description
TRACe{1-5}	Specifies the trace number (1 to 5)

	<numeric>
Description	<ul style="list-style-type: none"> <li>• Full-scale value in the linear Y-axis format<sup>*1</sup></li> <li>• Scale value in the polar format</li> <li>• Full-scale value in the complex plane format<sup>*1</sup></li> </ul>
Data type	Floating point
Range	Variable depending on the measurement parameter. <b>In the Linear Y-axis format:</b> 1E-3           Cs/Cp 1               B/D/tanδ (ε)/tanδ (μ)/G/ Y  2                Γ /Γx/Γy 10              Ls/Lp 360             θγ/θz/θy 1E3             Q 1E6              εr /εr'/εr''/ μr /μr'/μr''/R/Rs/Rp/ Z /X <b>In the Polar format:</b> 1               Z/Y/Γ/εr/μr <b>In the Complex format:</b> 500            Z/Y/Γ/εr/μr
Unit	Variable depending on the measurement parameter.

\*1. When one-tenths value of full-scale is set with the **DISP:TRAC{1-5}:Y:PDIV** command instead of setting full-scale value in the linear Y-axis or polar format, its 10-time value is set to the full-scale value.

**Query response**       {numeric}<newline><^END>

Related commands **DISP:TRAC{1-5}:Y:PDIV** command on page 368

Front Panel Equivalents **Scale - Scale...** - Full-scale|Scale

## DISP:TRAC{1-5}:Y:PDIV

Format DISPlay[:WINDow]:TRACe{1-5}:Y[:SCALe]:PDIVision <numeric>  
 DISPlay[:WINDow]:TRACe{1-5}:Y[:SCALe]:PDIVision?

Description Sets the Y-axis direction scale by using a one-tenths value of full-scale. However, the setting value here does not always have a one-to-one correspondence to the scale value per division.

In addition, use the **DISP:TRAC{1-5}:Y:FULL** command to set the full-scale value.

Parameters

Sub-block	Description
CALCulate{1-5}	Specifies the trace number (1 to 5).

	<numeric>
Description	One-tenths value of full-scale
Data type	Floating point
Range	Variable depending on the measurement parameter. <b>In the Linear Y-axis format:</b> 1E-4 Cs/Cp 0.1 B/D/tanδ (ε)/tanδ (μ)/G/ Y  0.2  Γ /Γx/Γy 1 Ls/Lp 36 θγ/θz/θy 1E2 Q 1E5  εr /εr'/εr''/ μr /μr'/μr''/R/Rs/Rp/Z/X <b>In the Complex format:</b> 50 Z/Y/Γ/εr/μr
Default	Variable depending on the measurement parameter.

Query response {numeric}<newline><^END>

Related commands **DISP:TRAC{1-5}:Y:FULL** command on page 367

Front Panel Equivalents Unavailable.

## DISP:TRAC{1-5}:Y:RLEV

**Format**                   DISPlay[:WINDow]:TRACe{1-5}:Y[:SCALe]:RLEVel <numeric>  
DISPlay[:WINDow]:TRACe{1-5}:Y[:SCALe]:RLEVel?

**Description**           Sets the following parameters for the display trace.

- Reference value in the linear Y-axis format
- Reference value of Y-axis in the complex plain format (center value)

**Parameters**

Sub-block	Description
TRACe{1-5}	Specifies the trace number (1 to 5)

	<numeric>
Description	<ul style="list-style-type: none"> <li>• Reference value in the linear Y-axis format</li> <li>• Reference value of the Y-axis in the complex plane format (center value)</li> </ul>
Data type	Floating point
Default	Variable depending on the measurement parameter. <b>In the Linear Y-axis format:</b> 5E-4               Cs/Cp 0.5                B/D/tanδ (ε)/tanδ (μ)/G/ Y  0                    Γ /Γ <sub>x</sub> /Γ <sub>y</sub> /θ <sub>γ</sub> /θ <sub>z</sub> /θ <sub>y</sub> 5                    Ls/Lp 500                Q 5E5                 ε <sub>r</sub>  /ε <sub>r</sub> '/ε <sub>r</sub> "/ μ <sub>r</sub>  /μ <sub>r</sub> '/μ <sub>r</sub> "/R/Rs/Rp/ Z /X <b>In the Complex format:</b> 0                   Z/Y/Γ/ε <sub>r</sub> /μ <sub>r</sub>
Unit	Variable depending on the measurement parameter

**Query response**       {numeric}<newline><^END>

**Related commands**   **DISP:TRAC{1-3}:Y:RPOS** command on page 370

**Front Panel**           **Scale - Scale...** - Ref Val|Ref Y  
**Equivalents**

## DISP:TRAC{1-3}:Y:RPOS

Format           DISPlay[:WINDow]:TRACe{1-3}:Y[:SCALe]:RPOSition <numeric>  
DISPlay[:WINDow]:TRACe{1-3}:Y[:SCALe]:RPOSition?

Description       Sets the following parameter for the display trace.

- Reference line position in the linear Y-axis format

### Parameters

Sub-block	Description
TRACe{1-3}	Specifies the trace number (1 to 3)

	<numeric>
Description	Reference line position in the linear Y-axis format
Data type	Floating point
Range	0 to 100
Default	50
Resolution	0.01

If the specified parameter is outside the range, the minimum (if the lower limit of the range is exceeded) or maximum value (if the upper limit is exceeded) will be assumed.

Query response   {numeric}<newline><^END>

Related commands **DISP:TRAC{1-5}:Y:RLEV** command on page 369

Front Panel       **Scale - Scale...** - Ref Pos  
Equivalents

## DISP:TRAC{1-3}:Y:SPAC

**Format**                   DISPlay[:WINDow]:TRACe{1-3}:Y:SPACing {LINer|LOGarithmic}  
DISPlay[:WINDow]:TRACe{1-3}:Y:SPACing?

**Description**           Selects the Y-axis display format when the rectangle format is selected.  
In addition, use the **DISP:TRAC{1-5}:GRAT:FORM** command to select the trace display format.

**Parameters**

Sub-block	Description
TRACe{1-3}	Specifies the trace number (1 to 3).

	Description
LINer (Default)	Specifies the linear Y-axis format
LOGarithmic	Specifies the logarithmic Y-axis format

**Query response**       {LIN|LOG}<newline><^END>

**Related commands**   **DISP:TRAC{1-5}:GRAT:FORM** on page 357

**Front Panel  
Equivalents**           **Meas/Format - Meas/Format...** - Format

## DISP:TRAC{1-3}:Y:TOP

**Format**                   DISPlay[:WINDow]:TRACe{1-3}:Y[:SCALe]:TOP <numeric>  
 DISPlay[:WINDow]:TRACe{1-3}:Y[:SCALe]:TOP?

**Description**           Sets the maximum scale value in the Y-axis direction for the scalar trace.  
 In addition, use the **DISP:TRAC{1-3}:Y:BOTT** command to set the minimum scale value.

**Parameters**

Sub-block	Description
TRACe{1-3}	Specifies the trace number (1 to 3).

	<numeric>
Description	Maximum scale value in the Y-axis direction
Data type	Floating point
Default	Variable depending on the measurement parameter. 1E-3                   Cs/Cp 1                        B/D/tanδ (ε)/tanδ (μ)/G/Γ/Γ <sub>x</sub> /Γ <sub>y</sub> / Y  10                       Ls/Lp 200                      θ <sub>γ</sub> /θ <sub>z</sub> /θ <sub>y</sub> 1E3                      Q 1E6                       ε <sub>r</sub>  /ε <sub>r</sub> '/ε <sub>r</sub> "/ μ <sub>r</sub>  /μ <sub>r</sub> '/μ <sub>r</sub> "/R/Rs/Rp/Z/X
Unit	Variable depending on the measurement parameter

**Query response**       {numeric}<newline><^END>

**Related commands**   **DISP:TRAC{1-3}:Y:BOTT** command on page 365

**Front Panel**           **Scale - Scale...** - Top  
**Equivalents**



## FORM:BORD

Format	FORMat:BOReDer {NORMal SWAPped} FORMat:BOReDer?						
Description	Selects the transfer order (byte order) of each byte of data (8 bytes) when binary transfer is selected for the data transfer format with the <b>FORM:DATA</b> command.						
Parameters	<table border="1" style="width: 100%; border-collapse: collapse; text-align: center;"> <thead> <tr> <th style="width: 30%;"></th> <th style="text-align: left;">Description</th> </tr> </thead> <tbody> <tr> <td>NORMal (Default)</td> <td style="text-align: left;">Specifies the byte order to start the transfer from the byte that contains MSB (Most Significant Bit).</td> </tr> <tr> <td>SWAPped</td> <td style="text-align: left;">Specifies the byte order to start the transfer from the byte that contains LSB (Least Significant Bit).</td> </tr> </tbody> </table>		Description	NORMal (Default)	Specifies the byte order to start the transfer from the byte that contains MSB (Most Significant Bit).	SWAPped	Specifies the byte order to start the transfer from the byte that contains LSB (Least Significant Bit).
	Description						
NORMal (Default)	Specifies the byte order to start the transfer from the byte that contains MSB (Most Significant Bit).						
SWAPped	Specifies the byte order to start the transfer from the byte that contains LSB (Least Significant Bit).						
Query response	{NORM SWAP}<newline><^END>						
Related commands	<b>FORM:DATA</b> command on page 374						
Front Panel Equivalents	Unavailable.						

## FORM:DATA

- Format**                    FORMat:DATA {ASCii[,0]|REAL[,32]|REAL[,64]}  
 FORMat:DATA?
- Description**            Sets the transfer format used for data transfer with the following GPIB commands:
- **DATA:CAD{1-8}? command on page 345**
  - **DATA:SEGM{1-16}:CAD{1-8}? command on page 350**
  - **DATA:CCO{1-6} command on page 346**
  - **DATA:SEGM{1-16}:CCO{1-6} command on page 351**
  - **DATA:CMD{1-2}? command on page 347**
  - **DATA:SEGM{1-16}:CMD{1-2}? command on page 352**
  - **DATA:CMP{1-3} command on page 348**
  - **DATA:SEGM{1-16}:CMP{1-3} command on page 353**
  - **DATA:RAW? command on page 349**
  - **CALC{1-5}:DATA? command on page 293**
  - **CALC:DATA:MON? command on page 292**
  - **SENS:CORR1:CKIT:STAN1:LIST:B command on page 424**
  - **SENS:CORR1:CKIT:STAN1:LIST:G command on page 425**
  - **SENS:CORR1:CKIT:STAN2:LIST:R command on page 427**
  - **SENS:CORR1:CKIT:STAN2:LIST:X command on page 428**
  - **SENS:CORR1:CKIT:STAN3:LIST:R command on page 431**
  - **SENS:CORR1:CKIT:STAN3:LIST:X command on page 432**
  - **SENS:CORR2:CKIT:STAN1:LIST:B command on page 443**
  - **SENS:CORR2:CKIT:STAN1:LIST:G command on page 444**
  - **SENS:CORR2:CKIT:STAN2:LIST:R command on page 446**
  - **SENS:CORR2:CKIT:STAN2:LIST:X command on page 447**
  - **SWE:STIM{1-4}? command on page 512**

**Parameters**

	<b>Description</b>
ASCii (Default)	Specifies the ASCII transfer format.
REAL, 32	Specifies the IEEE 32-bit floating-point format.
REAL, 64	Specifies the IEEE 64-bit floating-point format.

**Query response**            {ASC,0|REAL,32|REAL,64}<newline><^END>

**Front Panel  
 Equivalents**                Unavailable.

## FREQ

- Format** [SENSe:]FREQuency[:CW]:FIXed] <numeric>  
 [SENSe:]FREQuency[:CW]:FIXed]?
- Description** Sets the CW frequency for the oscillator level sweep, dc bias voltage sweep, or dc bias current sweep.
- Parameters** Either CW or FIXed can be written when describing the sub-block of the command, although [:CW]:FIXes] in the sub-block part can be omitted.

	<numeric>
Description	CW frequency
Data type	Floating point
Range	1E6 to 3E9
Default	1E6
Resolution	1E-3
Unit	Hz

If the specified parameter is outside the range, the minimum (if the lower limit of the range is exceeded) or maximum value (if the upper limit is exceeded) will be assumed.

- Query response** {numeric}<newline><^END>
- Front Panel  
 Equivalents** **Stimulus - Source...** - CW Freq: Hz

## **FREQ:CENT**

Format [SENSe:]FREQuency:CENTer <numeric>  
 [SENSe:]FREQuency:CENTer?

Description Sets the center value in the frequency sweep range (linear/log sweep).  
 In addition, use the **FREQ:SPAN** command to set the span value in the sweep range.

### Parameters

	<numeric>
Description	Center value in the sweep range
Data type	Floating point
Range	1E6 to 3E9
Default	1.5005E9
Resolution	1E-3
Unit	Hz

If the specified parameter is outside the range, the minimum (if the lower limit of the range is exceeded) or maximum value (if the upper limit is exceeded) will be assumed.

Query response {numeric}<newline><^END>

Related commands **FREQ:SPAN** command on page 377

Front Panel **Stimulus - Start/Stop...** - Center: Hz  
Equivalents

## FREQ:SPAN

Format [SENSe:]FREQuency:SPAN <numeric>  
 [SENSe:]FREQuency:SPAN?

Description Sets the span value in the frequency sweep range (linear/log sweep).  
 In addition, use the **FREQ:CENT** command to set the center value in the sweep range.

### Parameters

	<numeric>
Description	Span value in the sweep range
Data type	Floating point
Range	1E6 to 2999E6
Default	2.999E9
Resolution	1E-3
Unit	Hz

If the specified parameter is outside the range, the minimum (if the lower limit of the range is exceeded) or maximum value (if the upper limit is exceeded) will be assumed.

Query response {numeric}<newline><^END>

Related commands **FREQ:CENT** command on page 376

Front Panel Equivalents **Stimulus - Start/Stop...** - Span: Hz

## FREQ:SPAN:FULL

Format [SENSe:]FREQuency:SPAN:FULL

Description Sets the sweep range in full span (1 M to 3 GHz) for the frequency sweep (linear/log sweep). (No query)

Front Panel Equivalents Unavailable.

## **FREQ:STAR**

Format [SENSe:]FREQuency:STARt <numeric>  
 [SENSe:]FREQuency:STARt?

Description Sets the start value in the frequency sweep range (linear/log sweep).  
 In addition, use the **FREQ:STOP** command to set the stop value in the sweep range.

### Parameters

	<numeric>
Description	Start value in the sweep range
Data type	Floating point
Range	1E6 to 3E9
Default	1E6
Resolution	1E-3
Unit	Hz

If the specified parameter is outside the range, the minimum (if the lower limit of the range is exceeded) or maximum value (if the upper limit is exceeded) will be assumed.

Query response {numeric}<newline><^END>

Related commands **FREQ:STOP** command on page 379

Front Panel **Stimulus - Start/Stop...** - Start: Hz  
 Equivalents

## FREQ:STOP

**Format** [SENSe:]FREQuency:STOP <numeric>  
 [SENSe:]FREQuency:STOP?

**Description** Sets the stop value in the frequency sweep range (linear/log sweep).  
 In addition, use the **FREQ:STAR** command to set the start value in the sweep range.

**Parameters**

	<numeric>
Description	Stop value in the sweep range
Data type	Floating point
Range	1E6 to 3E9
Default	3E9
Resolution	1E-3
Unit	Hz

If the specified parameter is outside the range, the minimum (if the lower limit of the range is exceeded) or maximum value (if the upper limit is exceeded) will be assumed.

**Query response** {numeric}<newline><^END>

**Related commands** **FREQ:STAR** command on page 378

**Front Panel Equivalents** **Stimulus - Start/Stop...** - Stop: Hz

## HCOP

Format	HCOPy[:IMMediate]
Description	Outputs the print content selected with the <b>HCOP:CONT</b> command to a printer connected to the E4991A. (No query)
Related commands	<b>HCOP:CONT</b> command on page 380
Front Panel Equivalents	See <i>Operation Manual</i>

## HCOP:ABOR

Format	HCOPy:ABORt
Description	Aborts the print outputs. (No query)
Front Panel Equivalents	See <i>Operation Manual</i>

## HCOP:CONT

Format	HCOPy:CONTent {SCReen SETup LIST} HCOPy:CONTent?
Description	Selects the print content.
Parameters	

	Description
SCReen (Default)	Specifies the active graph for the graph display of the measurement result.
SETup	Specifies the text output of major setting parameters.
LIST	Specifies the list output of measurement result.

Query response	{SCR SET LIST}<newline><^END>
Related commands	<b>HCOP:IMAG</b> command on page 381
Front Panel Equivalents	<b>Display - Print - Graph(Color) Graph(Mono) List Values Operating Parameters</b>



## HCOP:IMAG

**Format** HCOPy:IMAGe {INVert|MONochrome}  
 HCOPy:IMAGe?

**Description** Selects the print color for the printer output.

**Parameters**

	Description
INVert <sup>*1</sup> (Default)	Specifies the color image (but background color is always white).
MONochrome	Specifies the monochrome image (inverted screen display color).

\*1. Can be selected when the print content is chosen for the measurement result graph display using the **HCOP:CONT** command.

**Query response** {INV|MON}<newline><<^END>

**Related commands** **HCOP:CONT** command on page 380

**Front Panel  
Equivalents** **Display - Print - Graph(Color)|Graph(Mono)**

**INIT**

**INIT**

Format INITiate[:IMMEDIATE]

Description The trigger system is started from the idle state when this command is executed. The idle state is resumed when the trigger cycle is performed once. Executing this command results in an error when the trigger system is not in the idle state or the trigger system is set to be started continuously (continuous start is specified with the **INIT:CONT** command). (No query)

Related commands **INIT:CONT** command on page 382

Front Panel Equivalents **Trigger - Single**

**INIT:CONT**

Format INITiate:CONTinuous {ON|OFF|1|0}  
INITiate:CONTinuous?

Description Sets whether to start the trigger system continuously.  
In addition, this is set to off when executing the **\*RST** command.

Parameters

	Description
ON or 1 (Default)	Instructs the instrument to continuously activate the trigger system.
OFF or 0	Instructs the instrument NOT to continuously activate the trigger system.

Query response {1|0}<newline><^END>

Related commands **\*RST** command on page 282

Front Panel Equivalents **Trigger - Continuous|Hold**

## MMEM:CAT?

Format	MMEMory:CATalog?
Description	Returns the list of files present in the current folder. (Query only)
Query response	{string}<newline><^END>  Files are separated by commas (,) when plural files are present. Empty quotation marks (“”) are returned when no file is present in the folder.
Front Panel Equivalents	<b>Save/Recall - Save State... Save Data... Save Graphics... Recall State... Recall Data...</b>

## MMEM:CDIR

Format	MMEMory:CDIRectory <string> MMEMory:CDIRectory?						
Description	Changes the current folder when saving or recalling the file.						
Parameters	<table border="1" style="width: 100%; border-collapse: collapse;"> <tr> <td style="width: 30%;"></td> <td style="text-align: center;"><b>&lt;String&gt;</b></td> </tr> <tr> <td>Description</td> <td>Specifies the full path of the folder hierarchy by using the drive name and the folder name.</td> </tr> <tr> <td>Default</td> <td>"D:\Documents"</td> </tr> </table>		<b>&lt;String&gt;</b>	Description	Specifies the full path of the folder hierarchy by using the drive name and the folder name.	Default	"D:\Documents"
	<b>&lt;String&gt;</b>						
Description	Specifies the full path of the folder hierarchy by using the drive name and the folder name.						
Default	"D:\Documents"						
Query response	{string}<newline><^END>						
Front Panel Equivalents	<b>Save/Recall - Save State... Save Data... Save Graphics... Recall State... Recall Data...</b>						

## MMEM:COPY

Format MMEMory:COPY <string 1>,<string 2>

Description Copies the file. (No query)

Parameters

	<string 1>	<string 2>
Description	Source file name to copy (with extension)	Destination file name to copy (with extension)
Range	Maximum 255 characters (including the extension)	Maximum 255 characters (including the extension)

Source and destination file names to copy have to be specified with an extension attached.

Front Panel Equivalents **Save/Recall - Save State...|Save Data...|Save Graphics...|Recall State...|Recall Data... - Copy to FDD**

## MMEM:DEL

Format MMEMory:DELeTe <string>

Description Deletes the file saved in the E4991A. (No query)

Parameters

	<string>
Description	File name to be deleted (with extension)
Range	Maximum 255 characters (including the extension)

File names must be specified with an extension attached.

Front Panel Equivalents **Save/Recall - Save State...|Save Data...|Save Graphics...|Recall State...|Recall Data... - Delete**

## MMEM:LOAD

Format MMEMory:LOAD[:STATe] <string>  
 Description Recalls the state file of the E4991A. (No query)  
 Parameters

	<b>&lt;string&gt;</b>
Description	File name to be recalled (no extension needs to be attached to the file name).
Range	Maximum 255 characters

Front Panel Equivalents **Save/Recall - Recall State... - OK**

## MMEM:LOAD:MACR

Format MMEMory:LOAD:MACRo <string>  
 Description Load the macro. (no query)  
 Parameters

	<b>&lt;String&gt;</b>
Description	File name to be loaded (no extension needs to be attached to the file name).
Range	Maximum 255 characters

Related commands **MMEM:STOR:MACR** command on page 390

Front Panel Equivalents **Utility - Load Program... - OK**

## **MMEM:LOAD:TRAC**

Format MMEMory:LOAD:TRACe <string>

Description Recalls the internal data array of the E4991A saved with the **MMEM:STOR:TRAC** command. (No query)

### Parameters

	<string>
Description	File name to be recalled (no extension needs to be attached to the file name).
Range	Maximum 255 characters

Related commands **MMEM:STOR:TRAC** command on page 391

Front Panel Equivalents **Save/Recall - Recall Data...** - OK

## **MMEM:MDIR**

Format MMEMory:MDIRectory <string>

Description Creates a new folder. (No query)

### Parameters

	<string>
Description	New folder name to create
Range	Maximum 255 characters

Front Panel Equivalents **Save/Recall - Save State...|Save Data...|Save Graphics...|Recall State...|Recall Data...** - New Folder

## MMEM:MOVE

Format MMEMory:MOVE <string 1>,<string 2>

Description Changes the specified file to another name. (No query)

Parameters

	<string 1>	<string 2>
Description	Original file name (with extension)	Changed file name (with extension)
Range	Maximum 255 characters (including the extension)	Maximum 255 characters (including the extension)

The file name has to be specified with an extension attached.

Front Panel Equivalents Unavailable.

## MMEM:RDIR

Format MMEMory:RDIRectory <string>

Description Deletes the folder. (No query)

Parameters

	<b>&lt;string&gt;</b>
Description	Folder name
Range	Up to 255 strings (including extension)

Front Panel Equivalents **Save/Recall - Save State...|Save Data...|Save Graphics...|Recall State...|Recall Data... - Delete**

## MMEM:STOR

Format MMEMory:STORe[:STATe] <string>

Description Saves the state file of E4991A.(No query)

The contents saved in the state file are as follows.

- Measurement conditions (Setting parameter)
- Data array/Data trace array
- Memory array/Memory trace array
- Calibration data array
- Fixture compensation data array
- Standard value of calibration kit defined by user
- Standard value of the fixture compensation kit defined by user

In addition, recall the saved state file with the **MMEM:LOAD** command.

Parameters

	<b>&lt;string&gt;</b>
Description	Saved file name (no need to attach extension to the file name)
Range	Up to 255 strings

Related commands **MMEM:LOAD** command on page 385

Front Panel Equivalents **Save/Recall - Save State... - OK**



## MMEM:STOR:CIT{1-3}

Format MMEMory:STORe:CIT{1-3} <string>

Description Saves the measurement data of the E4991A in the CITI file format. (No query)

Parameters

Sub block	Description
CIT1	Specifies 1-port model.
CIT2	Specifies 2-port Series model.
CIT3	Specifies 2-port Shunt model.

	<string>
Description	Saved file name (no need to attach extension to the file name)
Range	Up to 255 strings

Front Panel Equivalents **Save/Recall - Save Data...** - CITIfile - OK

## MMEM:STOR:GRAP

Format MMEMory:STORe:GRAPh[:JPG] <string>

Description Saves graph display of the screen in the JPEG format. (No query)

Parameters

	<string>
Description	Saved file name (no need to attach extension to the file name)
Range	Up to 255 strings

Related commands **MMEM:STOR:GRAP:BMP** command on page 390

Front Panel Equivalents **Save/Recall - Save Graphics...** - Jpeg - OK

## MMEM:STOR:GRAP:BMP

Format MMEMory:STORe:GRAPh:BMP <string>

Description Saves graph display of the screen in the Windows Bitmap format. (No query)

Parameters

	<string>
Description	Saved file name (no need to attach extension to the file name)
Range	Up to 255 strings

Related commands **MMEM:STOR:GRAP** command on page 389

Front Panel **Save/Recall - Save Graphics... - BMP - OK**  
Equivalents

## MMEM:STOR:MACR

Format MMEMory:STORe:MACRo <string>

Description Saves macro. (No Query)

Parameters

	<String>
Description	Saved file name (no need to attach extension to the file name)
Range	Up to 255 strings

Related commands **MMEM:LOAD:MACR** command on page 385

Front Panel **Utility - Save Program... - OK**  
Equivalents

## MMEM:STOR:TRAC

Format MMEMory:STORe:TRAC[:BINary] <string>

Description Saves the specified internal data array in binary form. (No query)  
 In addition, select the saving data array with the **MMEM:STOR:TRAC:SEL{1-4}** command.

Parameters

	<b>&lt;string&gt;</b>
Description	Saved file name (no need to attach extension to the file name)
Range	Up to 255 strings

Related commands **MMEM:STOR:TRAC:ASC** command on page 391  
**MMEM:STOR:TRAC:SEL{1-4}** command on page 392

Front Panel Equivalents **Save/Recall - Save Data...** - Binary - OK

## MMEM:STOR:TRAC:ASC

Format MMEMory:STORe:TRACe:ASCii <string>

Description Saves the specified internal array in ASCII format. (No query)  
 In addition, in order to select the saving data array, use the **MMEM:STOR:TRAC:SEL{1-4}** command.

Parameters

	<b>&lt;string&gt;</b>
Description	Saved file name (no need to attach extension to the file name)
Range	Up to 255 strings

Related commands **MMEM:STOR:TRAC** command on page 391  
**MMEM:STOR:TRAC:SEL{1-4}** command on page 392

Front Panel Equivalents **Save/Recall - Save Data...** - ASCII - OK

## MMEM:STOR:TRAC:SEL{1-4}

Format MMEMory:STORe:TRACe:SELEct{1-4} {ON|OFF|1|0}  
 MMEMory:STORe:TRACe:SELEct{1-4}?

Description When saving the internal data array with the **MMEM:STOR:TRAC** command or **MMEM:STOR:TRAC:ASC** command, sets whether to save the data array.

### Parameters

Sub-block	Description
SELEct1	Specifies data array.
SELEct2	Specifies data trace array.
SELEct3	Specifies memory array.
SELEct4	Specifies memory trace array.

	Description
ON or 1 (Default <sup>*1</sup> )	Specifies the setting to save the internal data array.
OFF or 0 (Default <sup>*2</sup> )	Specifies the setting NOT to save the internal data array.

\*1. data trace array/memory trace array

\*2. data array/memory array

Query response {1|0}<newline><^END>

Related commands **MMEM:STOR:TRAC** command on page 391

**MMEM:STOR:TRAC:ASC** command on page 391

Front Panel **Save/Recall - Save Data...** - Data|Memory|Trace Data|Trace Memory  
 Equivalents

## MODE

Format [SENSe:]MODE {IMPedance|PERMITtivity|PERMEAbility}  
 [SENSe:]MODE?

Description Selects the measurement mode of the E4991A.

Parameters

	Description
IMPedance (Default)	Specifies the impedance measurement mode.
PERMITtivity*1	Specifies the dielectric measurement mode.
PERMEAbility*1	Specifies the magnetic measurement mode.

\*1. This can be selected if Option 002 (materials measurement software) is installed.

Query response {IMP|PERMIT|PERMEA}<newline><^END>

Front Panel Equivalents **Utility - Material Option...** - Material Type

## PROG:CAT?

**Format**                    PROG:CATalog?

**Description**             Returns a list of macros. (Query only).

**Query response**         {String}<newline><^END>

Format of strings is <module name>.<procedure name>.

When multiple macros exist, they are separated by commas (.). Also, when no macro exists, empty quotation marks (“”) are returned.

**Front Panel  
Equivalents**           **Utility - VBA Macros...**

## PROG:NAME

**Format**                    PROG[[:SElected]]:NAME <string>

PROG[[:SElected]]:NAME?

**Description**             Defines the macro name. The **PROG:STAT** and **PROG:WAIT** commands are used in the macro name defined here.

**Parameters**

	<b>&lt;String&gt;</b>
Description	Macro name*1

\*1. Macro name is defined by <module name>.<procedure name>, or <procedure name>.

**Query response**         {String}<newline><^END>

Format of strings is <module name>.<procedure name>.

**Related commands**   **PROG:STAT** command on page 395  
**PROG:WAIT** command on page 395

**Front Panel  
Equivalents**           Unavailable.

## PROG:STAT

Format           PROGram[:SElected]:STATe {RUN|STOP}  
 PROGram[:SElected]:STATe?

Description       Sets the macro status.

Parameters

	Description
RUN	Executes macro.
STOP (Default)	Stops macro.

Query response    {RUN|STOP}<newline><^END>

Related commands **PROG:NAME** command on page 394

Front Panel       **Utility - Visual Basic Editor... - Run Macro|Break**  
 Equivalentents

## PROG:WAIT

Format           PROGram[:SElected]:WAIT  
 PROGram[:SElected]:WAIT?

Description       Waits until the macro changes to the stop condition from the execution condition.

Query response    {Numeric}<newline><^END>  
 When the macro changes to the stop condition, an integer value of 1 is returned.

Related commands **PROG:NAME** command on page 394

Front Panel       Unavailable.  
 Equivalentents

## SEGM{1-16}:AVER:COUN

**Format** [SENSe:]SEGMENT{1-16}:AVERage:COUNT <numeric>  
 [SENSe:]SEGMENT{1-16}:AVERage:COUNT?

**Description** When creating the segment sweep table, sets the point averaging factor.

**Parameters**

Sub-block	Description
SEGMENT {1-16}	Specifies the segment number (1 to 16).

	<numeric>
Description	Point averaging factor
Data type	Integer
Range	1 to 100
Default	1

If the specified parameter is outside the range, the minimum (if the lower limit of the range is exceeded) or maximum value (if the upper limit is exceeded) will be assumed.

**Query response** {numeric}<newline><^END>

**Front Panel  
 Equivalents** **Stimulus - Sweep Setup...** - Segment Table Menu - Point Average



## SEGM:COUN

**Format** [SENSe:]SEGMENT:COUNt <numeric>  
 [SENSe:]SEGMENT:COUNt?

**Description** After clearing the segment parameters within the segment sweep table, creates the specified number of new segments. In addition, all of the default segment parameters are inputted within the segment table.

**Parameters**

	<numeric>
Description	Total number of segments
Data type	Integer
Range	0*1 to 16
Default	0

\*1. When segment sweep is selected, it is not possible to set the number of segments to 0.

**Query response** {numeric}<newline><^END>

**Front Panel  
 Equivalents** Unavailable.

## SEGM{1-16}:CURR

**Format** [SENSe:]SEGMENT{1-16}:CURRENT[:LEVel] <numeric>  
 [SENSe:]SEGMENT{1-16}:CURRENT[:LEVel]?

**Description** When creating the segment sweep table, sets the oscillator current level.

**Parameters**

Sub-block	Description
SEGMENT {1-16}	Specifies the segment number (1 to 16).

	<numeric>
Description	Oscillator current level
Data type	Floating point
Range	0.1E-3 to 10E-3
Default	2E-3
Resolution	0.01E-3
Unit	A (ampere)

If the specified parameter is outside the range, the minimum (if the lower limit of the range is exceeded) or maximum value (if the upper limit is exceeded) will be assumed.

**Query response** {numeric}<newline><^END>

**Related commands** **SEGM:CURR:STAT** command on page 402

**Front Panel** **Stimulus - Sweep Setup...** - Segment Table Menu - More - Osc Level: A  
**Equivalents**

## SEGM:CURR:OFFS:STAT

**Format** [SENSe:]SEGMent:CURRent:OFFSet:STATe {ON|OFF|1|0}  
 [SENSe:]SEGMent:CURRent:OFFSet:STATe?

**Description** When creating the segment sweep table, selects the voltage mode to set the dc bias level. This command can be used when Option 001 (dc bias function) is installed.  
 In addition, use the **SEGM{1-16}:CURR:OFFS** command to select the current mode to set the dc bias level.

**Parameters**

	Description
ON or 1 (Default)	Specifies the current mode.
OFF or 0	Specifies the voltage mode.

**Query response** {1|0}<newline><^END>

**Related commands** **SEGM{1-16}:CURR:OFFS** command on page 401  
**SEGM{1-16}:VOLT:LIM** command on page 415

**Front Panel Equivalents** **Stimulus - Sweep Setup...** - Segment Table Menu - More - Bias Source

## SEGM{1-16}:CURR:LIM

Format [SENSe:]SEGMENT{1-16}:CURRENT:LIMIT <numeric>

[SENSe:]SEGMENT{1-16}:CURRENT:LIMIT?

Description When creating the segment sweep table, sets the dc bias current limit maximum value. This command is available when Option 001 (dc bias function) is installed.

### Parameters

Sub-block	Description
SEGMENT {1-16}	Specifies the segment number (1 to 16).

	<numeric>
Description	dc bias current limit maximum value
Data type	Floating point
Range	2E-3 to 50E-3
Default	2E-3
Resolution	0.01E-3
Unit	A (ampere)

If the specified parameter is outside the range, the minimum (if the lower limit of the range is exceeded) or maximum value (if the upper limit is exceeded) will be assumed.

Query response {numeric}<newline><^END>

Related commands **SEGM:VOLT:OFFS:STAT** command on page 417

**SEGM{1-16}:VOLT:OFFS** command on page 416

Front Panel Equivalents **Stimulus - Sweep Setup...** - Segment Table Menu - More - Bias Limit [A]

## SEGM{1-16}:CURR:OFFS

**Format** [SENSe:]SEGMent{1-16}:CURRent:OFFSet <numeric>  
 [SENSe:]SEGMent{1-16}:CURRent:OFFSet?

**Description** When creating the segment sweep table, sets the dc bias current level. This command is available when Option 001 (dc bias function) is installed.

**Parameters**

Sub-block	Description
SEGMent {1-16}	Specifies the segment number (1 to 16).

	<numeric>
Description	dc bias current level
Data type	Floating point
Range	-50E-3 to -100E-6, 100E-6 to 50E-3
Default	100E-6
Resolution	10E-6
Unit	A (ampere)

If the specified parameter is outside the range, the minimum (if the lower limit of the range is exceeded) or maximum value (if the upper limit is exceeded) will be assumed.

**Query response** {numeric}<newline><^END>

**Related commands** **SEGM:CURR:OFFS:STAT** command on page 399  
**SEGM{1-16}:VOLT:LIM** command on page 415

**Front Panel  
 Equivalent** **Stimulus - Sweep Setup...** - Segment Table Menu - More - Bias Level [A]

## **SEGM:CURR:STAT**

Format [SENSe:]SEGMent:CURRent:STATe {ON|OFF|1|0}  
[SENSe:]SEGMent:CURRent:STATe?

Description When creating the segment sweep table, selects the current mode to set the oscillator level. In addition, use the **SEGM{1-16}:CURR** command to set the oscillator current level.

### Parameters

	Description
ON or 1	Specifies the current mode.
OFF or 0 (Default)	Specifies the mode other than the current mode.*1

\*1. When specifying a mode other than the current mode, specify either the power mode or the voltage mode with the **SEGM:POW:STAT** command or **SEGM:VOLT:STAT** command.

Query response {1|0}<newline><^END>

Related commands **SEGM{1-16}:CURR** command on page 398  
**SEGM:POW:STAT** command on page 412  
**SEGM:VOLT:STAT** command on page 418

Front Panel Equivalents **Stimulus - Sweep Setup...** - Segment Table Menu - More - Osc Unit

## SEGM{1-16}:DATA

**Format** [SENSe:]SEGMent{1-16}:DATA <numeric 1>,<numeric 2>,<numeric 3>,<numeric 4>,<numeric 5>,<numeric 6>,<numeric 7>

**Description** When creating/editing the segment sweep table, simultaneously sets the parameter values of all segments. Before executing this GPIB command, you need to set the oscillator level to be read as current, dBm, or voltage by using the **SEGM:CURR:STAT** command, **SEGM:POW:STAT** command, or **SEGM:VOLT:STAT** command, respectively. When applying dc bias, you need to set either current or voltage by using the **SEGM:CURR:OFFS:STAT** command or **SEGM:VOLT:OFFS:STAT** command, respectively.

**Parameters**

Sub-block	Description
SEGMent {1-16}	Specifies the segment number (1 to 16).

	<numeric 1>	<numeric 2>	<numeric 3>	<numeric 4>
Description	Start frequency	Stop frequency	Number of points	Point averaging factor
Data type	Floating point		Integer	
Range	1E6 to 3E9	1E6 to 3E9	2 to 801*1	1 to 100
Default	1E6	3E9	2	1
Unit	Hz		None	

\*1. The number of points cannot be set beyond 801 points, which is the sum of the points in all segments.

	<numeric 5>	<numeric 6>	<numeric 7>
Description	Oscillator level	dc bias current/voltage level	dc bias voltage/current limit maximum value
Data type	Floating point		
Range	voltage: 5E-3 to 502E-3 current: 0.1E-3 to 10E-3 power: -40 to 1	voltage: -40 to 40 current: -50E-3 to -100E-6, 100E-6 to 50E-3	current: 2E-3 to 50E-3 voltage: 1 to 40

[GPIB Command Reference](#)  
**SEGM{1-16}:DATA**

	<numeric 5>	<numeric 6>	<numeric 7>
Default	voltage: 100E-3 current: 2E-3 power: -13.01	voltage: 0 current: 100E-6	current: 2E-3 voltage: 1
Unit	V/A/dBm	V/A	A/V

If the specified parameter is outside the range, the minimum (if the lower limit of the range is exceeded) or maximum value (if the upper limit is exceeded) will be assumed.

---

**NOTE**

It is necessary to set the parameters of numeric 6 and numeric 7 when Option 001 (dc bias function) is not installed or dc bias is not applied to the DUT. In this case, set default values such as 100uA and 1V to the parameters of numeric 6 and numeric 7, respectively.

---

Query response {numeric 1},{numeric 2},...,{numeric 7}<newline><^END>

Related commands **SEGM:CURR:STAT** command on page 402  
**SEGM:POW:STAT** command on page 412  
**SEGM:VOLT:STAT** command on page 418  
**SEGM:CURR:OFFS:STAT** command on page 399  
**SEGM:VOLT:OFFS:STAT** command on page 417

Front Panel  
 Equivalents Unavailable.



## SEGM:DATA:ALL

**Format** [SENSe:]SEGMENT:DATA:ALL <numeric 1>,<numeric 2>,<numeric 3>,<numeric 4>,<numeric 5>,<numeric 6>,<numeric 7>

**Description** When creating the segment sweep table, sets the same content parameter values in all of the segments. Before executing this GPIB command, you need to set the oscillator level to be read as current, dBm, or voltage by using the **SEGM:CURR:STAT** command, **SEGM:POW:STAT** command, or **SEGM:VOLT:STAT** command, respectively. When applying dc bias, you need to set either current or voltage by using the **SEGM:CURR:OFFS:STAT** command or **SEGM:VOLT:OFFS:STAT** command, respectively. (No query)

**Parameters**

	<numeric 1>	<numeric 2>	<numeric 3>	<numeric 4>
Description	Start frequency	Stop frequency	Number of points	Point averaging factor
Data type	Floating point		Integer	
Range	1E6 to 3E9	1E6 to 3E9	2 to 801*1	1 to 100
Default	1E6	3E9	2	1
Unit	Hz		None	

\*1. The number of points cannot be set beyond 801 points, which is the sum of the points in all segments.

	<numeric 5>	<numeric 6>	<numeric 7>
Description	Oscillator level	dc bias current/voltage level	dc bias voltage/current limit maximum value
Data type	Floating point		
Range	voltage: 5E-3 to 502E-3 current: 0.1E-3 to 10E-3 power: -40 to 1	voltage: -40 to 40 current: -50E-3 to -100E-6, 100E-6 to 50E-3	current: 2E-3 to 50E-3 voltage: 1 to 40

[GPIB Command Reference](#)  
**SEGM:DEL:ALL**

	<numeric 5>	<numeric 6>	<numeric 7>
Default	voltage: 100E-3 current: 2E-3 power: -13.01	voltage: 0 current: 100E-6	current: 2E-3 voltage: 1
Unit	V/A/dBm	V/A	A/V

If the specified parameter is outside the range, the minimum (if the lower limit of the range is exceeded) or maximum value (if the upper limit is exceeded) will be assumed.

**NOTE**

It is necessary to set the parameters of numeric 6 and numeric 7 when Option 001 (dc bias function) is not installed or dc bias is not applied to the DUT. In this case, set default values such as 100uA and 1V to the parameters of numeric 6 and numeric 7, respectively.

- Related commands
- SEGM:CURR:STAT** command on page 402
  - SEGM:POW:STAT** command on page 412
  - SEGM:VOLT:STAT** command on page 418
  - SEGM:CURR:OFFS:STAT** command on page 399
  - SEGM:VOLT:OFFS:STAT** command on page 417

Front Panel  
Equivalents      Unavailable.

**SEGM:DEL:ALL**

Format      [SENSe:]SEGMent:DELeTe:ALL

Description      Deletes all segments in the segment sweep table. In addition, this GPIB commnad is unavailable when the sweep parameter is set to segment sweep. (No query)

Front Panel  
Equivalents      Unavailable.

## SEGM{1-16}:FREQ:CENT

**Format** [SENSe:]SEGMENT{1-16}:FREQUency:CENTer <numeric>  
 [SENSe:]SEGMENT{1-16}:FREQUency:CENTer?

**Description** When creating the segment sweep table, sets the center value in the frequency sweep range. In addition, use the **SEGM{1-16}:FREQ:SPAN** command when setting the span value in the sweep range.

**Parameters**

Sub-block	Description
SEGMENT {1-16}	Specifies the segment number (1 to 16).

	<numeric>
Description	Center value in the sweep range
Data type	Floating point
Range	1E6 to 3E9
Default	1.5005E9
Resolution	1E-3
Unit	Hz

If the specified parameter is outside the range, the minimum (if the lower limit of the range is exceeded) or maximum value (if the upper limit is exceeded) will be assumed.

**Query response** {numeric}<newline><^END>

**Related commands** **SEGM{1-16}:FREQ:SPAN** command on page 408

**Front Panel Equivalents** Unavailable.

## SEGM{1-16}:FREQ:SPAN

**Format** [SENSe:]SEGMent{1-16}:FREQuency:SPAN <numeric>  
 [SENSe:]SEGMent{1-16}:FREQuency:SPAN?

**Description** When creating the segment sweep table, sets the span value in the frequency sweep range. In addition, use the **SEGM{1-16}:FREQ:CENT** command when setting the center value in the sweep range.

**Parameters**

Sub-block	Description
SEGMent {1-16}	Specifies the segment number (1 to 16).

	<numeric>
Description	Span value in the sweep range
Data type	Floating point
Range	0 to 2999E6
Default	2.999E9
Resolution	1E-3
Unit	Hz

If the specified parameter is outside the range, the minimum (if the lower limit of the range is exceeded) or maximum value (if the upper limit is exceeded) will be assumed.

**Query response** {numeric}<newline><^END>

**Related commands** **SEGM{1-16}:FREQ:CENT** command on page 407

**Front Panel  
 Equivalents** Unavailable.

## SEGM{1-16}:FREQ:STAR

**Format** [SENSe:]SEGMENT{1-16}:FREQUency:STARt <numeric>  
 [SENSe:]SEGMENT{1-16}:FREQUency:STARt?

**Description** When creating the segment sweep table, sets the start value in the frequency sweep range.  
 In addition, use the **SEGM{1-16}:FREQ:STOP** command when setting the stop value in the sweep range.

**Parameters**

Sub-block	Description
SEGMENT {1-16}	Specifies the segment number (1 to 16).

	<numeric>
Description	Start value in the sweep range
Data type	Floating point
Range	1E6 to 3E9
Default	1E6
Resolution	1E-3
Unit	Hz

If the specified parameter is outside the range, the minimum (if the lower limit of the range is exceeded) or maximum value (if the upper limit is exceeded) will be assumed.

**Query response** {numeric}<newline><^END>

**Related commands** **SEGM{1-16}:FREQ:STOP** command on page 410

**Front Panel Equivalents** **Stimulus - Sweep Setup...** - Segment Table Menu - Start

## SEGM{1-16}:FREQ:STOP

**Format** [SENSe:]SEGMent{1-16}:FREQuency:STARt <numeric>  
 [SENSe:]SEGMent{1-16}:FREQuency:STARt?

**Description** When creating the segment sweep table, sets the stop value in the frequency sweep range.  
 In addition, use the **SEGM{1-16}:FREQ:STAR** command when setting the start value in the sweep range.

**Parameters**

Sub-block	Description
SEGMent {1-16}	Specifies the segment number (1 to 16).

	<numeric>
Description	Stop value in the sweep range
Data type	Floating point
Range	1E6 to 3E9
Default	3E9
Resolution	1E-3
Unit	Hz

If the specified parameter is outside the range, the minimum (if the lower limit of the range is exceeded) or maximum value (if the upper limit is exceeded) will be assumed.

**Query response** {numeric}<newline><^END>

**Related commands** **SEGM{1-16}:FREQ:STAR** command on page 409

**Front Panel** **Stimulus - Sweep Setup...** - Segment Table Menu - Stop  
**Equivalents**

## SEGM{1-16}:POW

Format [SENSe:]SEGMent{1-16}:POWer[:LEVel] <numeric>  
 [SENSe:]SEGMent{1-16}:POWer[:LEVel]?

Description When creating the segment sweep table, sets the oscillator power level.

Parameters

Sub-block	Description
SEGMent {1-16}	Specifies the segment number (1 to 16).

	<numeric>
Description	Oscillator power level
Data type	Floating point
Range	-40 to 1
Default	-13.01
Unit	dBm

If the specified parameter is outside the range, the minimum (if the lower limit of the range is exceeded) or maximum value (if the upper limit is exceeded) will be assumed.

Query response {numeric}<newline><^END>

Related commands **SEGM:POW:STAT** command on page 412

Front Panel Equivalents **Stimulus - Sweep Setup...** - Segment Table Menu - More - Osc level: dBm

## SEGM:POW:STAT

Format [SENSe:]SEGMent:POWer:STATe {ON|OFF|1|0}  
 [SENSe:]SEGMent:POWer:STATe?

Description When creating the segment sweep table, selects the power mode to set the oscillator level.  
 In addition, use the **SEGM{1-16}:POW** command to set the oscillator power level.

### Parameters

	Description
ON or 1	Specifies the power (dBm) mode.
OFF or 0 (Default)	Specifies a mode other than power mode.*1

\*1. When specifying a mode other than the power mode, specify either current mode or voltage mode with the **SEGM:CURR:STAT** command or the **SEGM:VOLT:STAT** command, respectively.

Query response {1|0}<newline><^END>

Related commands **SEGM{1-16}:POW** command on page 411  
 **SEGM:CURR:STAT** command on page 402  
 **SEGM:VOLT:STAT** command on page 418

Front Panel **Stimulus - Sweep Setup...** - Segment Table Menu - More - Osc Unit  
 Equivalentents



## SEGM{1-16}:SWE:POIN

Format [SENSe:]SEGMENT{1-16}:SWEep:POINts <numeric>  
 [SENSe:]SEGMENT{1-16}:SWEep:POINts?

Description When creating the segment sweep table, sets the number of points measured at each segment.

Parameters

Sub-block	Description
SEGMENT {1-16}	Specifies the segment number (1 to 16).

	<numeric>
Description	Number of measurement points
Data type	Integer
Range	2 to 801 *1
Default	2

\*1. The number of points cannot be set beyond 801 points, which is the sum of the points in all segments.

Query response {numeric}<newline><^END>

Related commands **SWE:POIN** command on page 511

Front Panel Equivalents **Stimulus - Sweep Setup...** - Segment Table Menu - Number Of Points

## SEGM{1-16}:VOLT

**Format** [SENSe:]SEGMent{1-16}:VOLTage[:LEVel] <numeric>  
 [SENSe:]SEGMent{1-16}:VOLTage[:LEVel]?

**Description** When creating the segment sweep table, sets the oscillator voltage level.

**Parameters**

Sub-block	Description
SEGMent {1-16}	Specifies the segment number (1 to 16).

	<numeric>
Description	Oscillator voltage level
Data type	Floating point
Range	5E-3 to 502E-3
Default	100E-3
resolution	1E-3
Unit	V (volt)

If the specified parameter is outside the range, the minimum (if the lower limit of the range is exceeded) or maximum value (if the upper limit is exceeded) will be assumed.

**Query response** {numeric}<newline><^END>

**Related commands** **SEGM:VOLT:STAT** command on page 418

**Front Panel Equivalents** **Stimulus - Sweep Setup...** - Segment Table Menu - More - Osc Level: V

## SEGM{1-16}:VOLT:LIM

Format [SENSe:]SEGMent{1-16}:VOLTage:LIMit <numeric>  
[SENSe:]SEGMent{1-16}:VOLTage:LIMit?

Description When creating the segment sweep table, sets the dc bias voltage limit maximum value. This command is available when Option 001 (dc bias function) is installed.

Parameters

Sub-block	Description
SEGMent {1-16}	Specifies the segment number (1 to 16).

	<numeric>
Description	dc bias voltage limit maximum value
Data type	Floating point
Range	1 to 40
Default	1
Resolution	1E-3
Unit	V (volt)

If the specified parameter is outside the range, the minimum (if the lower limit of the range is exceeded) or maximum value (if the upper limit is exceeded) will be assumed.

Query response {numeric}<newline><^END>

Related commands **SEGM:CURR:OFFS:STAT** command on page 399  
**SEGM{1-16}:CURR:OFFS** command on page 401

Front Panel Equivalents **Stimulus - Sweep Setup...** - Segment Table Menu - More - Bias Limit [V]

## SEGM{1-16}:VOLT:OFFS

**Format** [SENSe:]SEGMent{1-16}:VOLTage:OFFSet <numeric>  
 [SENSe:]SEGMent{1-16}:VOLTage:OFFSet?

**Description** When creating the segment sweep table, sets the dc bias voltage level. This command is available when Option 001 (dc bias function) is installed.

**Parameters**

Sub-block	Description
SEGMent {1-16}	Specifies the segment number (1 to 16).

	<numeric>
Description	dc bias voltage level
Data type	Floating point
Range	-40 to 40
Default	0
Resolution	1E-3
Unit	V (volt)

If the specified parameter is outside the range, the minimum (if the lower limit of the range is exceeded) or maximum value (if the upper limit is exceeded) will be assumed.

**Query response** {numeric}<newline><^END>

**Related commands** **SEGM:VOLT:OFFS:STAT** command on page 417  
**SEGM{1-16}:CURR:LIM** command on page 400

**Front Panel** **Stimulus - Sweep Setup...** - Segment Table Menu - More - Bias Level [V]  
**Equivalents**

## SEGM:VOLT:OFFS:STAT

**Format** [SENSe:]SEGMENT:VOLTage:OFFSet:STATe {ON|OFF|1|0}  
 [SENSe:]SEGMENT:VOLTage:OFFSet:STATe?

**Description** When creating the segment sweep table, selects the voltage mode to set the dc bias level. This command can be used when Option 001 (dc bias function) is installed.  
 In addition, use the **SEGM{1-16}:VOLT:OFFS** command to select the current mode to set the dc bias voltage level.

**Parameters**

	Description
ON or 1	Specifies the voltage mode.
OFF or 0 (Default)	Specifies the current mode.

**Query response** {1|0}<newline><^END>

**Related commands** **SEGM{1-16}:VOLT:OFFS** command on page 416  
**SEGM{1-16}:CURR:LIM** command on page 400

**Front Panel Equivalents** **Stimulus - Sweep Setup...** - Segment Table Menu - More - Bias Source

## SEGM:VOLT:STAT

Format [SENSe:]SEGMent:VOLTage:STATe {ON|OFF|1|0}  
 [SENSe:]SEGMent:VOLTage:STATe?

Description When creating the segment sweep table, selects the voltage mode to set the oscillator level. In addition, use the **SEGM{1-16}:VOLT** command to set the oscillator voltage level.

### Parameters

	Description
ON or 1 (Default)	Specifies the voltage mode.
OFF or 0	Specifies a mode other than the voltage mode.*1

\*1. When specifying a mode other than the voltage mode, specify either the current mode or power mode with the **SEGM:CURR:STAT** command or the **SEGM:POW:STAT** command, respectively.

Query response {1|0}<newline><^END>

Related commands **SEGM{1-16}:VOLT** command on page 414  
 **SEGM:CURR:STAT** command on page 402  
 **SEGM:POW:STAT** command on page 412

Front Panel **Stimulus - Sweep Setup...** - Segment Table Menu - More - Osc Unit  
 Equivalentents

## SENS:CORR1

**Format** SENSE:CORRection1[:STATe] {OFF|0}  
 SENSE:CORRection1[:STATe]?

**Description** Resets the calibration data array and calibration coefficient array and turns off the calibration function. The calibration function cannot be set to on with this command.

**Parameters**

	<b>Description</b>
OFF or 0 (Default)	Turns off the calibration function.

**Query response** {1|0}<newline><^END>  
 When confirming the status by Query, 1 is returned if the calibration function is on.

**Related commands** **SENS:CORR1:COLL:SAVE** command on page 439

**Front Panel  
 Equivalents** **Stimulus - Cal/Comp...** - Cal Menu - Cal Reset

## **SENS:CORR1:CKIT**

**Format** SENSE:CORRection1:CKIT {DEFault|TEFLon|USER}  
SENSe:CORRection1:CKIT?

**Description** When measuring the calibration data, selects whether to use the 7-mm calibration kit supplied with the E4991A or a user-defined calibration kit prepared by the user.  
Also, in the dielectric measurement, selects the Load standard attached by Agilent test fixture.

**Parameters** For impedance measurement or magnetic measurement:

	<b>Description</b>
DEFault (Default)	Selects the 7-mm calibration kit supplied with E4991A.
USER	Selects the user-defined calibration kit.

For dielectric measurement:

	<b>Description</b>
TEFLon	Selects the Load standard supplied with Agilent test fixture.

**Query response** {DEF|TEFL|USER}<newline><^END>

**Front Panel  
Equivalents** **Stimulus - Cal/Comp...** - Cal Kit Menu - Cal Kit Type



## SENS:CORR1:CKIT:LIST

**Format** SENSE:CORRection1:CKIT:LIST[:STATe] {ON|OFF|1|0}  
 SENSE:CORRection1:CKIT:LIST[:STATe]?

**Description** When using a user-defined calibration kit for executing calibration, selects whether to specify the input value with or without the list setting function for each standard value of the calibration kit.

When the list setting function is set to on, standard values inputted by the following commands are used at the time of calibration.

- **SENS:CORR1:CKIT:STAN1:LIST:G** command on page 425
- **SENS:CORR1:CKIT:STAN1:LIST:B** command on page 424
- **SENS:CORR1:CKIT:STAN2:LIST:R** command on page 427
- **SENS:CORR1:CKIT:STAN2:LIST:X** command on page 428
- **SENS:CORR1:CKIT:STAN3:LIST:R** command on page 431
- **SENS:CORR1:CKIT:STAN3:LIST:X** command on page 432

When the list setting function is set to off, standard values inputted by the following commands are used at the time of calibration.

- **SENS:CORR1:CKIT:STAN1:G** command on page 423
- **SENS:CORR1:CKIT:STAN1:C** command on page 422
- **SENS:CORR1:CKIT:STAN2:R** command on page 429
- **SENS:CORR1:CKIT:STAN2:L** command on page 426
- **SENS:CORR1:CKIT:STAN3:R** command on page 433
- **SENS:CORR1:CKIT:STAN3:L** command on page 430

**Parameters**

	<b>Description</b>
ON or 1*1	Sets the list setting function to on.
OFF or 0 (Default)	Sets the list setting function to off.

\*1. This can only be used when measuring the calibration data in the user-defined frequency point/user-defined power point.

**Query response** {1|0}<newline><^END>

**Related commands** **SENS:CORR1:CKIT** command on page 420  
**SENS:CORR1:COLL:FPO** command on page 438

**Front Panel Equivalents** Unavailable.

## SENS:CORR1:CKIT:STAN1:C

Format SENSE:CORRection1:CKIT:STANdard1:C <numeric>

SENSE:CORRection1:CKIT:STANdard1:C?

Description Defines the capacitance value (C) of the Open standard of a user-defined calibration kit.

### Parameters

	<numeric>
Description	Capacitance value (C) of the Open standard
Data type	Floating point
Range	-1E6 to 1E6
Default	0
Unit	F

If the specified parameter is outside the range, the minimum (if the lower limit of the range is exceeded) or maximum value (if the upper limit is exceeded) will be assumed.

Query response {numeric}<newline><^END>

Related commands **SENS:CORR1:CKIT:LIST** command on page 421

**SENS:CORR1:CKIT:STAN1:G** command on page 423

Front Panel **Stimulus - Cal/Comp...** - Cal Kit Menu - Open C: (F)  
Equivalents

## SENS:CORR1:CKIT:STAN1:G

**Format** SENSE:CORRection1:CKIT:STANdard1:G <numeric>  
 SENSE:CORRection1:CKIT:STANdard1:G?

**Description** Defines the conductance value (G) of the Open standard of a user-defined calibration kit.

**Parameters**

	<numeric>
Description	Conductance value (G) of the Open standard
Data type	Floating point
Range	-1E6 to 1E6
Default	0
Unit	S (Siemens)

If the specified parameter is outside the range, the minimum (if the lower limit of the range is exceeded) or maximum value (if the upper limit is exceeded) will be assumed.

**Query response** {numeric}<newline><^END>

**Related commands** **SENS:CORR1:CKIT:LIST** command on page 421  
**SENS:CORR1:CKIT:STAN1:C** command on page 422

**Front Panel Equivalents** **Stimulus - Cal/Comp...** - Cal Kit Menu - Open G: (S)

## **SENS:CORR1:CKIT:STAN1:LIST:B**

**Format**                    SENSE:CORRection1:CKIT:STANdard1:LIST:B <numeric 1>,<numeric 2>,...,<numeric N>  
                               SENSE:CORRection1:CKIT:STANdard1:LIST:B?

**Description**            Defines the susceptance value (B) of the Open standard of a user-defined calibration kit with the list setting function.  
  
 When using the list setting function, the susceptance value (B) of the Open standard, defined for the calibration data throughout the entire frequency range, is set for the exact number of measurement points (N).

---

**NOTE**                    The standard value defined with the list setting function can only be used when measuring the calibration data in the user-defined frequency point/user-defined power point.

---

### Parameters

	<b>&lt;numeric n&gt;</b>
Description	Susceptance value (B) of the Open standard
Data type	Floating point
Range	-1E6 to 1E6
Default	0
Unit	S (Siemens)

If the specified parameter is outside the range, the minimum (if the lower limit of the range is exceeded) or maximum value (if the upper limit is exceeded) will be assumed.

**Query response**        {numeric 1}, {numeric 2},..., {numeric N}<newline><^END>  
 Where N is the number of measurement points.

**Related commands**    **SENS:CORR1:CKIT:LIST** command on page 421  
                               **SENS:CORR1:CKIT:STAN1:LIST:G** command on page 425  
                               **FORM:DATA** command on page 374

**Front Panel  
 Equivalents**            Unavailable.

## SENS:CORR1:CKIT:STAN1:LIST:G

**Format** SENSE:CORRection1:CKIT:STANdard1:LIST:G <numeric 1>,<numeric 2>,...,<numeric N>  
 SENSE:CORRection1:CKIT:STANdard1:LIST:G?

**Description** Defines the conductance value (G) of the Open standard of a user-defined calibration kit with the list setting function.  
 When using the list setting function, the conductance value (G) of the Open standard, defined for the calibration data throughout the entire frequency range, is set for the exact number of measurement points (N).

**NOTE** The standard value defined with the list setting function can only be used when measuring the calibration data in the user-defined frequency point/user-defined power point.

**Parameters**

	<numeric n>
Description	Conductance value (G) of the Open standard
Data type	Floating point
Range	-1E6 to 1E6
Default	0
Unit	S (Siemens)

If the specified parameter is outside the range, the minimum (if the lower limit of the range is exceeded) or maximum value (if the upper limit is exceeded) will be assumed.

**Query response** {numeric1}, {numeric 2},..., {numeric N}<newline><^END>  
 Where N is the number of measurement points.

**Related commands** **SENS:CORR1:CKIT:LIST** command on page 421  
**SENS:CORR1:CKIT:STAN1:C** command on page 422  
**FORM:DATA** command on page 374

**Front Panel Equivalents** Unavailable.

## **SENS:CORR1:CKIT:STAN2:L**

Format SENSE:CORRection1:CKIT:STANdard2:L <numeric>

SENSE:CORRection1:CKIT:STANdard2:L?

Description Defines the inductance value (L) of the Short standard of a user-defined calibration kit.

### Parameters

	<numeric>
Description	Inductance value (L) of the Short standard
Data type	Floating point
Range	-1E6 to 1E6
Default	0
Unit	H

If the specified parameter is outside the range, the minimum (if the lower limit of the range is exceeded) or maximum value (if the upper limit is exceeded) will be assumed.

Query response {numeric}<newline><^END>

Related commands **SENS:CORR1:CKIT:LIST** command on page 421

**SENS:CORR1:CKIT:STAN2:R** command on page 429

Front Panel **Stimulus - Cal/Comp...** - Cal Kit Menu - Short L: (H)  
Equivalents

## SENS:CORR1:CKIT:STAN2:LIST:R

**Format**                    SENSE:CORRection1:CKIT:STANdard2:LIST:R <numeric 1>,<numeric 2>,...,<numeric N>  
 SENSE:CORRection1:CKIT:STANdard2:LIST:R?

**Description**            Defines the resistance value (R) of the Short standard of a user-defined calibration kit by using the list setting function.

When using the list setting function, the resistance value (R) of the Short standard, defined for the calibration data throughout the entire frequency range, is set for the exact number of measurement points (N).

---

**NOTE**                    The standard value defined with the list setting function can only be used when measuring the calibration data in the user-defined frequency point/user-defined power point.

---

**Parameters**

	<b>&lt;numeric n&gt;</b>
Description	Resistance value (R) of the Short standard
Data type	Floating point
Range	-1E6 to 1E6
Default	0
Unit	Ω (ohm)

If the specified parameter is outside the range, the minimum (if the lower limit of the range is exceeded) or maximum value (if the upper limit is exceeded) will be assumed.

**Query response**        {numeric 1}, {numeric 2},..., {numeric N}<newline><^END>  
 Where N is the number of measurement points.

**Related commands**    **SENS:CORR1:CKIT:LIST** command on page 421  
**SENS:CORR1:CKIT:STAN2:R** command on page 429  
**FORM:DATA** command on page 374

**Front Panel  
 Equivalents**            Unavailable.

## **SENS:CORR1:CKIT:STAN2:LIST:X**

**Format** SENSE:CORRection1:CKIT:STANdard2:LIST:X <numeric 1>,<numeric 2>,...,<numeric N>  
 SENSE:CORRection1:CKIT:STANdard2:LIST:X?

**Description** Defines the reactance value (X) of the Short standard of a user-defined calibration kit by using the list setting function.  
 When using the list setting function, the reactance value (X) of the Short standard, defined for the calibration data throughout the entire frequency range, is set for the exact number of measurement points (N).

---

**NOTE** The standard value defined by using the list setting function can only be used when measuring the calibration data in the user-defined frequency point/user-defined power point.

---

**Parameters**

	<b>&lt;numeric n&gt;</b>
Description	Reactance value (X) of the Short standard
Data type	Floating point
Range	-1E6 to 1E6
Default	0
Unit	$\Omega$ (ohm)

If the specified parameter is outside the range, the minimum (if the lower limit of the range is exceeded) or maximum value (if the upper limit is exceeded) will be assumed.

**Query response** {numeric 1}, {numeric 2},..., {numeric N}<newline><^END>  
 Where N is the number of measurement points.

**Related commands** **SENS:CORR1:CKIT:LIST** command on page 421  
**SENS:CORR1:CKIT:STAN2:LIST:R** command on page 427  
**FORM:DATA** command on page 374

**Front Panel Equivalents** Unavailable.



## SENS:CORR1:CKIT:STAN2:R

**Format** SENSE:CORRection1:CKIT:STANdard2:R <numeric>  
 SENSE:CORRection1:CKIT:STANdard2:R?

**Description** Defines the resistance value (R) of the Short standard of a user-defined calibration kit.

**Parameters**

	<numeric>
Description	Resistance value (R) of the Short standard
Data type	Floating point
Range	-1E6 to 1E6
Default	0
Unit	$\Omega$ (ohm)

If the specified parameter is outside the range, the minimum (if the lower limit of the range is exceeded) or maximum value (if the upper limit is exceeded) will be assumed.

**Query response** {numeric}<newline><^END>

**Related commands** **SENS:CORR1:CKIT:LIST** command on page 421  
**SENS:CORR1:CKIT:STAN2:L** command on page 426

**Front Panel Equivalents** **Stimulus - Cal/Comp...** - Cal Kit Menu - Short R: ( $\Omega$ )

## SENS:CORR1:CKIT:STAN3:L

Format SENSE:CORRection1:CKIT:STANdard3:L <numeric>

SENSE:CORRection1:CKIT:STANdard3:L?

Description Defines the inductance value (L) of the Load standard of a user-defined calibration kit.

### Parameters

	<numeric>
Description	Inductance value (L) of the Load standard
Data type	Floating point
Range	-1E6 to 1E6
Default	0
Unit	H

If the specified parameter is outside the range, the minimum (if the lower limit of the range is exceeded) or maximum value (if the upper limit is exceeded) will be assumed.

Query response {numeric}<newline><^END>

Related commands **SENS:CORR1:CKIT:LIST** command on page 421

**SENS:CORR1:CKIT:STAN3:R** command on page 433

Front Panel **Stimulus - Cal/Comp...** - Cal Kit Menu - Load L: (H)  
Equivalents

## SENS:CORR1:CKIT:STAN3:LIST:R

**Format**                    SENSE:CORRection1:CKIT:STANdard3:LIST:R <numeric 1>,<numeric 2>,...,<numeric N>

SENSe:CORRection1:CKIT:STANdard3:LIST:R?

**Description**            Defines the resistance value (R) of the Load standard of a user-defined calibration kit by using the list setting function.

When using the list setting function, the resistance value (R) of the Load standard, defined for the calibration data throughout the entire frequency range, is set for the exact number of measurement points (N).

---

**NOTE**                    The standard value defined by using the list setting function can only be used when measuring the calibration data in the user-defined frequency point/user-defined power point.

---

**Parameters**

	<b>&lt;numeric n&gt;</b>
Description	Resistance value (R) of the Load standard
Data type	Floating point
Range	-1E6 to 1E6
Default	50
Unit	Ω (ohm)

If the specified parameter is outside the range, the minimum (if the lower limit of the range is exceeded) or maximum value (if the upper limit is exceeded) will be assumed.

**Query response**        {numeric 1}, {numeric 2},..., {numeric N}<newline><^END>

Where N is the number of measurement points.

**Related commands**    **SENS:CORR1:CKIT:LIST** command on page 421  
**SENS:CORR1:CKIT:STAN3:LIST:X** command on page 432  
**FORM:DATA** command on page 374

**Front Panel  
Equivalents**                Unavailable.

## SENS:CORR1:CKIT:STAN3:LIST:X

**Format** SENSE:CORRection1:CKIT:STANdard3:LIST:X <numeric 1>,<numeric 2>,...,<numeric N>  
 SENSE:CORRection1:CKIT:STANdard3:LIST:X?

**Description** Defines the reactance value (X) of the Load standard of a user-defined calibration kit by using the list setting function.  
 When using the list setting function, reactance value (X) of the Load standard, defined for the calibration data throughout the entire frequency range, is set for the exact number of measurement points (N).

---

**NOTE** The standard value defined by using the list setting function is available only when measuring the calibration data in the user-defined frequency point/user-defined power point.

---

### Parameters

	<numeric n>
Description	Reactance value (X) of the Load standard
Data type	Floating point
Range	-1E6 to 1E6
Default	0
Unit	$\Omega$ (ohm)

If the specified parameter is outside the range, the minimum (if the lower limit of the range is exceeded) or maximum value (if the upper limit is exceeded) will be assumed.

**Query response** {numeric 1}, {numeric 2},..., {numeric N}<newline><^END>  
 Where N is the number of measurement points.

**Related commands** **SENS:CORR1:CKIT:LIST** command on page 421  
**SENS:CORR1:CKIT:STAN3:LIST:R** command on page 431  
**FORM:DATA** command on page 374

**Front Panel Equivalents** Unavailable.

## SENS:CORR1:CKIT:STAN3:R

**Format** SENSE:CORRection1:CKIT:STANdard3:R <numeric>  
 SENSE:CORRection1:CKIT:STANdard3:R?

**Description** Defines the resistance value (R) of the Load standard of a user-defined calibration kit.

**Parameters**

	<numeric>
Description	Resistance value (R) of the Load standard
Data type	Floating point
Range	-1E6 to 1E6
Default	50
Unit	$\Omega$ (ohm)

If the specified parameter is outside the range, the minimum (if the lower limit of the range is exceeded) or maximum value (if the upper limit is exceeded) will be assumed.

**Query response** {numeric}<newline><^END>

**Related commands** **SENS:CORR1:CKIT:LIST** command on page 421  
**SENS:CORR1:CKIT:STAN3:L** command on page 430

**Front Panel Equivalents** **Stimulus - Cal/Comp...** - Cal Kit Menu - Load R: ( $\Omega$ )

## **SENS:CORR1:CKIT:STAN7:PLF**

**Format** SENSE:CORRection1:CKIT:STANdard7:PLFactor <numeric>  
SENSE:CORRection1:CKIT:STANdard7:PLFactor?

**Description** Defines the dielectric dissipation factor of the Load standard of the calibration kit in dielectric measurement. This command can be used when Option 002 (material measurement software) is installed.

### Parameters

	<b>&lt;numeric&gt;</b>
Description	Dielectric dissipation factor of the Load standard
Data type	Floating point
Range	-1E6 to 1E6
Default	0

If the specified parameter is outside the range, the minimum (if the lower limit of the range is exceeded) or maximum value (if the upper limit is exceeded) will be assumed.

**Query response** {numeric}<newline><^END>

**Related commands** **SENS:CORR1:CKIT:STAN7:PRE** command on page 435  
**SENS:CORR1:CKIT:STAN7:THIC** command on page 436

**Front Panel  
Equivalents** **Stimulus - Cal/Comp...** - Cal Kit Menu -  $\epsilon_r$  Loss

## SENS:CORR1:CKIT:STAN7:PRE

**Format**                    SENSE:CORRection1:CKIT:STANdard7:PREal <numeric>  
                               SENSE:CORRection1:CKIT:STANdard7:PREal?

**Description**            Defines the dielectric constant ratio of the Load standard of the calibration kit in dielectric measurement. This command can be used when Option 002 (material measurement software) is installed.

**Parameters**

	<numeric>
Description	Dielectric constant ratio of the Load standard
Data type	Floating point
Range	-1E6 to 1E6
Default	2.1

If the specified parameter is outside the range, the minimum (if the lower limit of the range is exceeded) or maximum value (if the upper limit is exceeded) will be assumed.

**Query response**        {numeric}<newline><^END>

**Related commands**    **SENS:CORR1:CKIT:STAN7:PLF** command on page 434  
                               **SENS:CORR1:CKIT:STAN7:THIC** command on page 436

**Front Panel**            **Stimulus - Cal/Comp...** - Cal Kit Menu -  $\epsilon_r$  Real  
**Equivalents**

## **SENS:CORR1:CKIT:STAN7:THIC**

**Format**                    SENSE:CORRection1:CKIT:STANdard7:THICkness <numeric>  
                                SENSE:CORRection1:CKIT:STANdard7:THICkness?

**Description**            Defines the thickness of the Load standard of the calibration kit in dielectric measurement. This command can be used when Option 002 (material measurement software) is installed.

### Parameters

	<b>&lt;numeric&gt;</b>
Description	Thickness of the Load standard
Data type	Floating point
Range	-1E6 to 1E6
Default	800E-6
Unit	m (meter)

If the specified parameter is outside the range, the minimum (if the lower limit of the range is exceeded) or maximum value (if the upper limit is exceeded) will be assumed.

**Query response**        {numeric}<newline><^END>

**Related commands**    **SENS:CORR1:CKIT:STAN7:PLF** command on page 434  
                                **SENS:CORR1:CKIT:STAN7:PRE** command on page 435

**Front Panel**            **Stimulus - Cal/Comp...** - Cal Kit Menu - Thickness  
**Equivalents**



## SENS:CORR1:COLL

**Format** SENSE:CORRection1:COLLect[:ACQuire]  
 {STAN1|STAN2|STAN3|STAN4|STAN5|STAN6|STAN7}

**Description** Measures calibration data. (No query)

**Parameters** For impedance measurement or magnetic measurement:

	<b>Description</b>
STAN1	Open calibration data is measured.
STAN2	Short calibration data is measured.
STAN3	Load calibration data is measured.
STAN4	Low-loss capacitor calibration data is measured.

For dielectric measurement:

	<b>Description</b>
STAN5	Open calibration data is measured.
STAN6	Short calibration data is measured.
STAN7	Load calibration data is measured.

**Front Panel  
 Equivalents** **Stimulus - Cal/Comp...** - Cal Menu - Meas Open|Meas Short|Meas Load|Meas Low Loss  
 C(Optional)

## SENS:CORR1:COLL:FPO

**Format**                    SENSE:CORRection1:COLLect:FPOints {FIXed|FUSer|USER}  
                               SENSE:CORRection1:COLLect:FPOints?

**Description**            Selects whether to measure the calibration data at the measurement point prepared by the E4991A (fixed point) or at the measurement point set by the user (user-defined point). In addition, the measurement point of the calibration data is linked with the measurement point of the fixture compensation data selected with the **SENS:CORR2:COLL:FPO** command.

**Parameters**

	<b>Description</b>
FIXed (Default)	The calibration data is measured at the fixed frequency point and over the entire oscillator level range prepared by the E4991A's "Fixed frequency/fixed power points." After execution of calibration, the calibration function is valid even if the measured frequency and oscillator level are altered.
FUSer	The calibration data is measured by the combination of the fixed frequency point prepared by the E4991A and the oscillator level value set by the user's "Fixed frequency/user-defined power points." In addition, this measurement point can be selected when frequency linear/log sweep is selected as the sweep type. After execution of calibration, the calibration function is disabled if the oscillator level is altered.
USER	The calibration data is measured at the frequency point set by the user and the oscillator level's "User-defined frequency/user-defined power points." After execution of calibration, the calibration function is disabled if the measured frequency or the oscillator level is altered.

**Query response**        {FIX|FUS|USER}<newline><^END>

**Related commands**    **SENS:CORR2:COLL:FPO** command on page 450

**Front Panel**            **Stimulus - Cal/Comp...** - Cal Menu - Cal Type  
**Equivalents**

## **SENS:CORR1:COLL:SAVE**

Format	SENSe:CORRection1:COLLect:SAVE
Description	By using the acquired calibration data, calculates the calibration coefficient and automatically sets the calibration function to on. If this command is used before measuring all of the calibration data of Open, Short, and Load with the <b>SENS:CORR1:COLL</b> command, an error will occur and the command will be ignored. (No query)
Related commands	<b>SENS:CORR1:COLL</b> command on page 437 <b>SENS:CORR1</b> command on page 419
Front Panel Equivalents	<b>Stimulus - Cal/Comp...</b> - Cal Menu - Done

## SENS:CORR2:CKIT:LIST

**Format** SENSE:CORRection2:CKIT:LIST[:STATe] {ON|OFF|1|0}  
 SENSE:CORRection2:CKIT:LIST[:STATe]?

**Description** When executing fixture compensation with the fixture compensation kit, selects whether to specify the input value with or without using the list setting function on each standard value of the fixture compensation kit.

When the list setting function is set to on, standard values inputted with the following commands are used at the time of fixture compensation.

- **SENS:CORR2:CKIT:STAN1:LIST:G** command on page 444
- **SENS:CORR2:CKIT:STAN1:LIST:B** command on page 443
- **SENS:CORR2:CKIT:STAN2:LIST:R** command on page 446
- **SENS:CORR2:CKIT:STAN2:LIST:X** command on page 447

When the list setting function is set to off, standard values inputted with the following commands are used at the time of fixture compensation.

- **SENS:CORR2:CKIT:STAN1:G** command on page 442
- **SENS:CORR2:CKIT:STAN1:C** command on page 441
- **SENS:CORR2:CKIT:STAN2:R** command on page 448
- **SENS:CORR2:CKIT:STAN2:L** command on page 445

**Parameters**

	<b>Description</b>
ON or 1*1	Sets the list setting function to on.
OFF or 0 (Default)	Sets the list setting function to off.

\*1. This can be used only when measuring the fixture compensation data in the user-defined frequency point/user-defined power point.

**Query response** {1|0}<newline><^END>

**Related commands** **SENS:CORR2:COLL:FPO** command on page 450

**Front Panel Equivalents** Unavailable.

## SENS:CORR2:CKIT:STAN1:C

**Format** SENSE:CORRection2:CKIT:STANdard1:C <numeric>  
 SENSE:CORRection2:CKIT:STANdard1:C?

**Description** Defines the capacitance value (C) of the Open standard of the fixture compensation kit.

**Parameters**

	<numeric>
Description	Capacitance value (C) of the Open standard
Data type	Floating point
Range	-1E6 to 1E6
Default	0
Unit	F

If the specified parameter is outside the range, the minimum (if the lower limit of the range is exceeded) or maximum value (if the upper limit is exceeded) will be assumed.

**Query response** {numeric}<newline><^END>

**Related commands** **SENS:CORR2:CKIT:LIST** command on page 440  
**SENS:CORR2:CKIT:STAN1:G** command on page 442

**Front Panel Equivalents** **Stimulus - Cal/Comp...** - Cal Kit Menu - Open C: (F)

## SENS:CORR2:CKIT:STAN1:G

Format SENSE:CORRection2:CKIT:STANdard1:G <numeric>

SENSe:CORRection2:CKIT:STANdard1:G?

Description Defines the conductance value (G) of the Open standard of the fixture compensation kit.

### Parameters

	<numeric>
Description	Conductance value (G) of the Open standard
Data type	Floating point
Range	-1E6 to 1E6
Default	0
Unit	S (Siemens)

If the specified parameter is outside the range, the minimum (if the lower limit of the range is exceeded) or maximum value (if the upper limit is exceeded) will be assumed.

Query response {numeric}<newline><^END>

Related commands **SENS:CORR2:CKIT:LIST** command on page 440

**SENS:CORR2:CKIT:STAN1:C** command on page 441

Front Panel **Stimulus - Cal/Comp...** - Comp Kit Menu - Open G: (S)  
Equivalents

## SENS:CORR2:CKIT:STAN1:LIST:B

**Format**                    SENSE:CORRection2:CKIT:STANdard1:LIST:B <numeric 1>,<numeric 2>,...,<numeric N>  
 SENSE:CORRection2:CKIT:STANdard1:LIST:B?

**Description**            Defines the susceptance value (B) of the Open standard of the fixture compensation kit by using the list setting function.

When using the list setting function, the susceptance value (B) of the Open standard, defined for the calibration data throughout the entire frequency range, is set for the exact number of measurement points (N).

---

**NOTE**                    The standard value defined by the list setting function can be used when measuring the fixture compensation data in the user-defined frequency point/user-defined power point.

---

**Parameters**

	<b>&lt;numeric n&gt;</b>
Description	Susceptance value (B) of the Open standard
Data type	Floating point
Range	-1E6 to 1E6
Default	0
Unit	S (Siemens)

If the specified parameter is outside the range, the minimum (if the lower limit of the range is exceeded) or maximum value (if the upper limit is exceeded) will be assumed.

**Query response**        {numeric 1}, {numeric 2},..., {numeric N}<newline><^END>  
 Where N is the number of measurement points.

**Related commands**    **SENS:CORR2:CKIT:LIST** command on page 440  
**SENS:CORR2:CKIT:STAN1:LIST:G** command on page 444  
**FORM:DATA** command on page 374

**Front Panel  
 Equivalents**            Unavailable.

## SENS:CORR2:CKIT:STAN1:LIST:G

**Format** SENSE:CORRection2:CKIT:STANdard1:LIST:G <numeric 1>,<numeric 2>,...,<numeric N>  
 SENSE:CORRection2:CKIT:STANdard1:LIST:G?

**Description** Defines the conductance value (G) of the Open standard of the fixture compensation kit by using the list setting function..  
 When using the list setting function, the conductance value (G) of the Open standard, defined for the calibration data throughout the entire frequency range, is set for the exact number of measurement points (N).

---

**NOTE** The standard value defined by the list setting function can be used when measuring the fixture compensation data in the user-defined frequency point/user-defined power point.

---

### Parameters

	<numeric n>
Description	Conductance value (G) of the Open standard
Data type	Floating point
Range	-1E6 to 1E6
Default	0
Unit	S (Siemens)

If the specified parameter is outside the range, the minimum (if the lower limit of the range is exceeded) or maximum value (if the upper limit is exceeded) will be assumed.

**Query response** {numeric 1}, {numeric 2},..., {numeric N}<newline><^END>  
 Where N is the number of measurement points.

**Related commands** **SENS:CORR2:CKIT:LIST** command on page 440  
**SENS:CORR2:CKIT:STAN1:LIST:B** command on page 443  
**FORM:DATA** command on page 374

**Front Panel Equivalents** Unavailable.



## SENS:CORR2:CKIT:STAN2:L

**Format** SENSE:CORRection2:CKIT:STANdard2:L <numeric>  
 SENSE:CORRection2:CKIT:STANdard2:L?

**Description** Defines the inductance value (L) of the Short standard of the fixture compensation kit.

**Parameters**

	<numeric>
Description	Inductance value (L) of the Short standard
Data type	Floating point
Range	-1E6 to 1E6
Default	0
Unit	H

If the specified parameter is outside the range, the minimum (if the lower limit of the range is exceeded) or maximum value (if the upper limit is exceeded) will be assumed.

**Query response** {numeric}<newline><^END>

**Related commands** **SENS:CORR2:CKIT:LIST** command on page 440  
**SENS:CORR2:CKIT:STAN2:R** command on page 448

**Front Panel Equivalents** **Stimulus - Cal/Comp...** - Comp Kit Menu - Short L: (H)

## **SENS:CORR2:CKIT:STAN2:LIST:R**

**Format**                    SENSE:CORRection2:CKIT:STANdard2:LIST:R <numeric 1>,<numeric 2>,...,<numeric N>  
                               SENSE:CORRection2:CKIT:STANdard2:LIST:R?

**Description**            Defines the resistance value (R) of the Short standard of the fixture compensation kit by using the list setting function.  
  
 When using the list setting function, the resistance value (R) of the Short standard, defined for the calibration data throughout the entire frequency range, is set for the exact number of measurement points (N).

---

**NOTE**                    The standard value defined by the list setting function can be used when measuring the fixture compensation data in the user-defined frequency point/user-defined power point.

---

**Parameters**

	<b>&lt;numeric n&gt;</b>
Description	Resistance value (R) of the Short standard
Data type	Floating point
Range	-1E6 to 1E6
Default	0
Unit	Ω (ohm)

If the specified parameter is outside the range, the minimum (if the lower limit of the range is exceeded) or maximum value (if the upper limit is exceeded) will be assumed.

**Query response**        {numeric 1}, {numeric 2},... {numeric N}<newline><^END>  
 Where N is the number of measurement points.

**Related commands**    **SENS:CORR2:CKIT:LIST** command on page 440  
                               **SENS:CORR2:CKIT:STAN2:LIST:X** command on page 447  
                               **FORM:DATA** command on page 374

**Front Panel  
 Equivalents**            Unavailable.

## SENS:CORR2:CKIT:STAN2:LIST:X

**Format**                    SENSE:CORRection2:CKIT:STANdard2:LIST:X <numeric 1>,<numeric 2>,...,<numeric N>  
 SENSE:CORRection2:CKIT:STANdard2:LIST:X?

**Description**            Defines the reactance value (X) of the Short standard of the fixture compensation kit by using the list setting function.

When using the list setting function, the reactance value (X) of the Short standard, defined for the calibration data throughout the entire frequency range, is set for the exact number of measurement points (N).

---

**NOTE**                    The standard value defined by the list setting function can be used when measuring the fixture compensation data in the user-defined frequency point/user-defined power point.

---

**Parameters**

	<b>&lt;numeric n&gt;</b>
Description	Reactance value (X) of the Short standard
Data type	Floating point
Range	-1E6 to 1E6
Default	0
Unit	Ω (ohm)

If the specified parameter is outside the range, the minimum (if the lower limit of the range is exceeded) or maximum value (if the upper limit is exceeded) will be assumed.

**Query response**        {numeric 1}, {numeric 2},..., {numeric N}<newline><^END>  
 Where N is the number of measurement points.

**Related commands**    **SENS:CORR2:CKIT:LIST** command on page 440  
**SENS:CORR2:CKIT:STAN2:LIST:R** command on page 446  
**FORM:DATA** command on page 374

**Front Panel  
 Equivalents**            Unavailable.

## SENS:CORR2:CKIT:STAN2:R

Format                    SENSE:CORRection2:CKIT:STANdard2:R <numeric>  
                            SENSE:CORRection2:CKIT:STANdard2:R?

Description             Defines the resistance value (R) of the Short standard of the fixture compensation kit.

### Parameters

	<numeric>
Description	Resistance value of the Short standard (R)
Data type	Floating point
Range	-1E6 to 1E6
Default	0
Unit	$\Omega$ (ohm)

If the specified parameter is outside the range, the minimum (if the lower limit of the range is exceeded) or maximum value (if the upper limit is exceeded) will be assumed.

Query response        {numeric}<newline><^END>

Related commands    **SENS:CORR2:CKIT:LIST** command on page 440  
                            **SENS:CORR2:CKIT:STAN2:L** command on page 445

Front Panel            **Stimulus - Cal/Comp...** - Comp Kit Menu - Short R: ( $\Omega$ )  
Equivalents

## SENS:CORR2:COLL

**Format** SENSE:CORRection2:COLLect[:ACQuire] {STAN1|STAN2|STAN9}

**Description** Measures fixture compensation data. (No query)

**Parameters** For impedance measurement:

	<b>Description</b>
STAN1	Open compensation data is measured.
STAN2	Short compensation data is measured.

For magnetic measurement:

	<b>Description</b>
STAN9	Short compensation data is measured.

**Front Panel  
 Equivalents** **Stimulus - Cal/Comp...** - Comp Menu - Meas Open|Meas Short

## SENS:CORR2:COLL:FPO

Format SENSE:CORRection2:COLLect:FPOints {FIXed|FUSer|USER}

SENSE:CORRection2:COLLect:FPOints?

Description Selects whether to measure the fixture compensation data at the measurement point prepared by the E4991A (fixed point) or at the measurement point set by the user (user-defined point). In addition, the measurement point of the compensation data is linked with the measurement point of the calibration data selected with the **SENS:CORR1:COLL:FPO** command.

### Parameters

	Description
FIXed (Default)	The fixture compensation data is measured at the fixed frequency point and over the entire oscillator level range prepared by the E4991A's "Fixed frequency/fixed power points." After execution of fixture compensation, the fixture compensation function is valid even if the measured frequency and oscillator level are altered.
FUSer	The fixture compensation data is measured by the combination of the fixed frequency point prepared by the E4991A and the oscillator level value set by the user's "Fixed frequency/user-defined power points." In addition, this measurement point can be selected when frequency linear/log sweep is selected as the sweep type. After execution of fixture compensation, the fixture compensation function is disabled if the oscillator level is altered. (In addition, since the calibration function is disabled, the measurement of calibration data needs to be re-executed.)
USER	The fixture compensation data is measured at the frequency point set by the user and the oscillator level's "User-defined frequency/user-defined power points." After execution of fixture compensation, the fixture compensation function is disabled if the measured frequency or the oscillator level is altered. (In addition, since calibration is disabled, calibration needs to be re-executed.)

Query response {FIX|FUS|USER}<newline><^END>

Related commands **SENS:CORR1:COLL:FPO** command on page 438

Front Panel **Stimulus - Cal/Comp...** - Cal Menu - Cal Type  
 Equivalents

## SENS:CORR2:COLL:OPEN

**Format** SENSE:CORRection2:COLLect:OPEN[:STATe] {ON|OFF|1|0}  
 SENSE:CORRection2:COLLect:OPEN[:STATe]?

**Description** Turns on/off the Open compensation function. At this time, the fixture compensation coefficient is re-calculated. If this command is executed before measuring the Open compensation data with the **SENS:CORR2:COLL** command, an error will occur and the command will be ignored.

**Parameters**

	Description
ON or 1	Turns on the Open compensation function.
OFF or 0 (Default)	Turns off the Open compensation function.

**Query response** {1|0}<newline><^END>

**Related commands** **SENS:CORR2:COLL** command on page 449

**Front Panel Equivalents** **Stimulus - Cal/Comp...** - Comp Menu - Comp Open [On/Off]

## SENS:CORR2:COLL:SAVE

**Format** SENSE:CORRection2:COLLect:SAVE

**Description** Calculates the fixture compensation coefficient and sets the fixture compensation function to on. If this command is executed before measuring the fixture compensation data with the **SENS:CORR2:COLL** command, an error will occur and the command will be ignored. (No query)

**Related commands** **SENS:CORR2:COLL** command on page 449

**Front Panel Equivalents** **Stimulus - Cal/Comp...** - Comp Menu - Done

## **SENS:CORR2:COLL:SHOR**

**Format** SENS:CORRection2:COLLect:SHORt[:STATe] {ON|OFF|1|0}  
SENS:CORRection2:COLLect:SHORt[:STATe]?

**Description** Turns on/off the Short compensation function. At this time, the fixture compensation coefficient is re-calculated. If this command is executed before measuring the Short compensation data with the **SENS:CORR2:COLL** command, an error will occur and the command will be ignored.

**Parameters**

	<b>Description</b>
ON or 1	Turns on the Short compensation function.
OFF or 0 (Default)	Turns off the Short compensation function.

**Query response** {1|0}<newline><^END>

**Related commands** **SENS:CORR2:COLL** command on page 449

**Front Panel  
Equivalents** **Stimulus - Cal/Comp...** - Comp Menu - Comp Short [On/Off]



## SENS:CORR2:EDEL:TIME

**Format** SENSE:CORRection2:EDELay:TIME <numeric>  
 SENSE:CORRection2:EDELay:TIME?

**Description** If there is an error related to port extension, aside from electrical length of the test fixture, an offset delay time is set and compensated.

**Parameters**

	<numeric>
Description	Offset delay time
Data type	Floating point
Range	-1E6 to 1E6
Default	0
Unit	S (seconds)

If the specified parameter is outside the range, the minimum (if the lower limit of the range is exceeded) or maximum value (if the upper limit is exceeded) will be assumed.

**Query response** {numeric}<newline><^END>

**Front Panel  
 Equivalents** **Stimulus - Cal/Comp...** - Port Extension: (Sec)

## SENS:CORR2:FIXT

**Format** SENSE:CORRection2:FIXTure  
 {NONE|FXT16191A|FXT16192A|FXT16193A|FXT16194A|FXT16196A|FXT16196B|FXT16196C|FXT16197A|FXT16453A|FXT16454S|FXT16454L|USER}  
 SENSE:CORRection2:FIXTure?

**Description** Selects the test fixture.

**Parameters**

	Description
NONE (Default in impedance measurement)	No test fixture is selected.
FXT16191A	Specifies Agilent 16191A.
FXT16192A	Specifies Agilent 16192A.
FXT16193A	Specifies Agilent 16193A.
FXT16194A	Specifies Agilent 16194A.
FXT16196A	Specifies Agilent 16196A.
FXT16196B	Specifies Agilent 16196B.
FXT16196C	Specifies Agilent 16196C.
FXT16197A	Specifies Agilent 16197A.
FXT16453A <sup>*1</sup>	Specifies Agilent 16453A.
FXT16454S <sup>*2</sup> (Default in magnetic measurement)	Specifies Agilent 16454S.
FXT16454L <sup>*2</sup>	Specifies Agilent 16454L.
USER <sup>*3</sup>	Specifies the test fixture created by user (custom test fixture).

\*1. Only in electric mode.

\*2. Only in magnetic mode.

\*3. When using the custom test fixture, it is necessary to compensate the electrical length error with the **SENS:CORR2:FIXT:EDEL:USER:DIST** command.

**Query response** {NONE|FXT16191A|FXT16192A|FXT16193A|FXT16194A|FXT16196A|FXT16196B|FXT16196C|FXT16197A|FXT16453A|FXT16454S|FXT16454L|USER} <newline><^END >

**Related commands** **SENS:CORR2:FIXT:EDEL:USER:DIST** command on page 456

Front Panel Equivalents      **Stimulus - Cal/Comp...** - Fixture Type

**SENS:CORR2:FIXT:EDEL:MODE:DIST?**

Format      SENSE:CORRection2:FIXTure:EDELay:MODEl:DISTance?  
 {NONE|FXT16191A|FXT16192A|FXT16193A|FXT16194A|FXT16196A|FXT16196B|FXT16196C|FXT16197A}

Description      Reads the standard value of the electrical length of the specified Agilent test fixture.  
 (Query only)

Parameters

	Description
NONE	No test fixture is selected.
FXT16191A	Specifies Agilent 16191A.
FXT16192A	Specifies Agilent 16192A.
FXT16193A	Specifies Agilent 16193A.
FXT16194A	Specifies Agilent 16194A.
FXT16196A	Specifies Agilent 16196A.
FXT16196B	Specifies Agilent 16196B.
FXT16196C	Specifies Agilent 16196C.
FXT16197A	Specifies Agilent 16197A.

Query response      {numeric}<newline><^END>  
 Numeric of the floating point is sensed.

Related commands      **SENS:CORR2:FIXT** command on page 454

Front Panel Equivalents      Unavailable.

## SENS:CORR2:FIXT:EDEL:USER:DIST

**Format** SENSE:CORRection2:FIXTure:EDELay:USER:DISTanCe <numeric>  
 SENSE:CORRection2:FIXTure:EDELay:USER:DISTanCe?

**Description** Sets the electrical length that compensates for the delay caused by the connection of a custom test fixture. If you want to configure the instrument for your custom test fixture connected to the DUT PORT, use this command to set an electrical length that can compensate for the resulting delay.

### Parameters

	<numeric>
Description	Electrical length
Data type	Floating point
Range	-1E3 to 1E3
Default	0
Unit	m (meter)

If the specified parameter is outside the range, the minimum (if the lower limit of the range is exceeded) or maximum value (if the upper limit is exceeded) will be assumed.

**Query response** {numeric}<newline><^END>

**Related commands** **SENS:CORR2:FIXT** command on page 454

**Front Panel  
Equivalents** **Stimulus - Cal/Comp...** - Fixture Length: (m)

## SOUR:CURR

**Format**                    SOURce:CURRent[:LEVel][:IMMediate][:AMPLitude] <numeric>  
                               SOURce:CURRent[:LEVel][:IMMediate][:AMPLitude]?

**Description**            Sets the oscillator current level when the sweep parameter is set to frequency sweep, dc bias voltage sweep, or dc bias current sweep.

**Parameters**

	<b>&lt;numeric&gt;</b>
Description	Oscillator current level
Data type	Floating point
Range	0.1E-3 to 10E-3
Default	2.0E-3
Resolution	0.01E-3
Unit	A (ampere)

If the specified parameter is outside the range, the minimum (if the lower limit of the range is exceeded) or maximum value (if the upper limit is exceeded) will be assumed.

**Query response**        {numeric}<newline><^END>

**Related commands**    **SOUR:CURR:MODE** command on page 460

**Front Panel  
Equivalents**            **Stimulus - Source...** - OSC Level: A

## **SOUR:CURR:CENT**

Format           SOURce:CURRent:CENTer <numeric>  
                  SOURce:CURRent:CENTer?

Description       Sets the center value in the oscillator current level sweep range.  
  
                  In addition, use the **SOUR:CURR:SPAN** command to set the span value in the sweep range.

### Parameters

	<b>&lt;numeric&gt;</b>
Description	Center value in the sweep range
Data type	Floating point
Range	0.1E-3 to 10E-3
Default	6.0E-3
Resolution	0.01E-3
Unit	A (ampere)

If the specified parameter is outside the range, the minimum (if the lower limit of the range is exceeded) or maximum value (if the upper limit is exceeded) will be assumed.

Query response   {numeric}<newline><^END>

Related commands **SOUR:CURR:MODE** command on page 460  
**SOUR:CURR:SPAN** command on page 467

Front Panel       **Stimulus - Start/Stop...** - Center: A  
Equivalentents

## SOUR:CURR:LIM:OFFS

**Format** SOURce:CURRent:LIMit:OFFSet <numeric>  
 SOURce:CURRent:LIMit:OFFSet?

**Description** Sets the dc bias current limit maximum value when the dc bias output mode is set to the voltage sweep mode or the fixed voltage source mode. This command can be used when Option 001 (dc bias function) is installed.

**Parameters**

	<b>&lt;numeric&gt;</b>
Description	dc bias current limit maximum value
Data type	Floating point
Range	2E-3 to 50E-3
Default	2E-3
Resolution	0.01E-3
Unit	A (ampere)

If the specified parameter is outside the range, the minimum (if the lower limit of the range is exceeded) or maximum value (if the upper limit is exceeded) will be assumed.

**Query response** {numeric}<newline><^END>

**Related commands** **Stimulus - Source...** - Bias Limit: A

## **SOUR:CURR:MODE**

Format                   SOURce:CURRent:MODE {FIXed|SWEep}  
                          SOURce:CURRent:MODE?

Description            Selects the oscillator current level mode.

Parameters

	<b>Description</b>
FIXed (Default)	Specifies the fixed current mode.
SWEep	Specifies the current sweep mode.

Query response        {FIX|SWE}<newline><^END>

Related commands    **SWE:TYPE** command on page 515  
                      **SOUR:POW:MODE** command on page 472  
                      **SOUR:VOLT:MODE** command on page 479

Front Panel  
Equivalents           **Stimulus - Source...** - Osc Unit



## SOUR:CURR:OFFS

**Format** SOURce:CURRent[:LEVel][:IMMediate][:AMPLitude]:OFFSet <numeric>  
 SOURce:CURRent[:LEVel][:IMMediate][:AMPLitude]:OFFSet?

**Description** Sets the dc bias current level in the fixed current source mode. This command can be used when Option 001 (dc bias function) is installed.

**Parameters**

	<numeric>
Description	dc bias current level
Data type	Floating point
Range	-50E-3 to -100E-6, 100E-6 to 50E-3
Default	100E-6
Resolution	10E-6
Unit	A (ampere)

If the specified parameter is outside the range, the minimum (if the lower limit of the range is exceeded) or maximum value (if the upper limit is exceeded) will be assumed.

**Query response** {numeric}<newline><^END>

**Front Panel  
 Equivalents** **Stimulus - Source...** - Bias Level: A

## SOUR:CURR:OFFS:CENT

**Format**                    SOURce:CURRent[:LEVel][:IMMediate][:AMPLitude]:OFFSet:CENTer <numeric>  
 SOURce:CURRent[:LEVel][:IMMediate][:AMPLitude]:OFFSet:CENTer?

**Description**            Sets the center value in the dc bias current sweep range. This command can be used when Option 001 (dc bias function) is installed.  
  
 In addition, in order to set the span value of the sweep range, the **SOUR:CURR:OFFS:SPAN** command is used.

**Parameters**

	<numeric>
Description	Center value in the sweep range
Data type	Floating point
Range	-50E-3 to 50E-3-3
Default	100E-6
Resolution	10E-6
Unit	A (ampere)

If the specified parameter is outside the range, the minimum (if the lower limit of the range is exceeded) or maximum value (if the upper limit is exceeded) will be assumed.

**Query response**        {numeric}<newline><^END>

**Related commands**    **SOUR:CURR:OFFS:SPAN** command on page 463

**Front Panel**            **Stimulus - Start/Stop...** - Center: A  
**Equivalents**

## SOUR:CURR:OFFS:SPAN

**Format**                    SOURce:CURRent[:LEVel][:IMMediate][:AMPLitude]:OFFSet:SPAN <numeric>  
 SOURce:CURRent[:LEVel][:IMMediate][:AMPLitude]:OFFSet:SPAN?

**Description**            Sets the span value in the dc bias current sweep range. This command can be used when Option 001 (dc bias function) is installed.  
  
 In addition, use the **SOUR:CURR:OFFS:CENT** command to set the center value of the sweep range.

**Parameters**

	<numeric>
Description	Span value in the sweep range
Data type	Floating point
Range	0 to 100E-3
Default	0
Resolution	10E-6
Unit	A (ampere)

If the specified parameter is outside the range, the minimum (if the lower limit of the range is exceeded) or maximum value (if the upper limit is exceeded) will be assumed.

**Query response**        {numeric}<newline><^END>

**Related commands**    **SOUR:CURR:OFFS:CENT** command on page 462

**Front Panel**            **Stimulus - Start/Stop...** - Span: A  
**Equivalents**

## **SOUR:CURR:OFFS:STAR**

**Format**                    SOURce:CURRent[:LEVel][:IMMediate][:AMPLitude]:OFFSet:STARt <numeric>  
SOURce:CURRent[:LEVel][:IMMediate][:AMPLitude]:OFFSet:STARt?

**Description**            Sets the start value in the dc bias current sweep range. This command can be used when Option 001 (dc bias function) is installed.

In addition, use the **SOUR:CURR:OFFS:STOP** command to set the stop value of the sweep range.

### Parameters

	<b>&lt;numeric&gt;</b>
Description	Start value in the sweep range
Data type	Floating point
Range	-50E-3 to 50E-3
Default	100E-6
Resolution	10E-6
Unit	A (ampere)

**Query response**        {numeric}<newline><^END>

**Related commands**    **SOUR:CURR:OFFS:STOP** command on page 466

**Front Panel**            **Stimulus - Start/Stop...** - Start: A  
**Equivalents**

## SOUR:CURR:OFFS:STAT

**Format** SOURce:CURRent[:LEVel][:IMMediate][:AMPLitude]:OFFSet:STATe {ON|OFF|1|0}  
 SOURce:CURRent[:LEVel][:IMMediate][:AMPLitude]:OFFSet:STATe?

**Description** Turns on/off the dc bias output in the current sweep mode or the fixed current source mode. This command can be used when Option 001 (dc bias function) is installed.

**Parameters**

	<b>Description</b>
ON or 1	Turn on the dc bias output.*1
OFF or 0 (Default)	Turn off the dc bias output.

\*1. When the dc bias is turned on from off, the sweep mode is automatically set to hold.

**Query response** {1|0}<newline><^END>

**Related commands** **SOUR:VOLT:OFFS:STAT** command on page 484

**Front Panel  
 Equivalents** **Stimulus - Source...** - dc bias: [On/Off]

## SOUR:CURR:OFFS:STOP

**Format**                    SOURce:CURRent[:LEVel][:IMMediate][:AMPLitude]:OFFSet:STOP <numeric>  
 SOURce:CURRent[:LEVel][:IMMediate][:AMPLitude]:OFFSet:STOP?

**Description**            Sets the stop value in the dc bias current sweep range. This command can be used when Option 001 (dc bias function) is installed.  
  
 In addition, use the **SOUR:CURR:OFFS:STAR** command to set the start value in the sweep range.

**Parameters**

	<b>&lt;numeric&gt;</b>
Description	Stop value in the sweep range
Data type	Floating point
Range	-50E-3 to 50E-3
Default	100E-6
Resolution	10E-6
Unit	A (ampere)

If the specified parameter is outside the range, the minimum (if the lower limit of the range is exceeded) or maximum value (if the upper limit is exceeded) will be assumed.

**Query response**        {numeric}<newline><^END>

**Related commands**    **SOUR:CURR:OFFS:STAR** command on page 464

**Front Panel**            **Stimulus - Start/Stop...** - Stop: A  
**Equivalents**

## SOUR:CURR:SPAN

**Format** SOURce:CURRent:SPAN <numeric>  
 SOURce:CURRent:SPAN?

**Description** Sets the span value in the oscillator current level sweep range.  
 In addition, use the **SOUR:CURR:CENT** command to set the center value of the sweep range.

**Parameters**

	<numeric>
Description	Span value in the sweep range
Data type	Floating point
Range	0 to 9.9E-3
Default	4E-3
Resolution	0.01E-3
Unit	A (ampere)

If the specified parameter is outside the range, the minimum (if the lower limit of the range is exceeded) or maximum value (if the upper limit is exceeded) will be assumed.

**Query response** {numeric}<newline><^END>

**Related commands** **SOUR:CURR:MODE** command on page 460  
**SOUR:CURR:CENT** command on page 458

**Front Panel Equivalents** **Stimulus - Start/Stop...** - Span: A

## **SOUR:CURR:STAR**

**Format**                   SOURce:CURRent:STARt <numeric>  
                              SOURce:CURRent:STARt?

**Description**           Sets the start value in the oscillator current level sweep range.  
  
                              In addition, use the **SOUR:CURR:STOP** command to set the stop value of the sweep range.

**Parameters**

	<b>&lt;numeric&gt;</b>
Description	Start value in the sweep range
Data type	Floating point
Range	0.1 to 10E-3
Default	4E-3
Resolution	0.01E-3
Unit	A (ampere)

If the specified parameter is outside the range, the minimum (if the lower limit of the range is exceeded) or maximum value (if the upper limit is exceeded) will be assumed.

**Query response**       {numeric}<newline><^END>

**Related commands**   **SOUR:CURR:MODE** command on page 460  
**SOUR:CURR:STOP** command on page 469

**Front Panel  
Equivalents**           **Stimulus - Start/Stop...** - Start: A



## SOUR:CURR:STOP

**Format** SOURce:CURRent:STOP <numeric>  
 SOURce:CURRent:STOP?

**Description** Sets the stop value in the oscillator current level sweep range.  
 In addition, use the **SOUR:CURR:STAR** command to set the start value of the sweep range.

**Parameters**

	<numeric>
Description	Stop value in the sweep range
Data type	Floating point
Range	0.1 to 10E-3
Default	8E-3
Resolution	0.01E-3
Unit	A (ampere)

If the specified parameter is outside the range, the minimum (if the lower limit of the range is exceeded) or maximum value (if the upper limit is exceeded) will be assumed.

**Query response** {numeric}<newline><^END>

**Related commands** **SOUR:CURR:MODE** command on page 460  
**SOUR:CURR:STAR** command on page 468

**Front Panel Equivalents** **Stimulus - Start/Stop...** - Stop: A

**SOUR:POW**

**SOUR:POW**

Format                    SOURce:POWer[:LEVel][:IMMediate][:AMPLitude] <numeric>  
                           SOURce:POWer[:LEVel][:IMMediate][:AMPLitude]?

Description             Sets the oscillator power level when the sweep parameter is set to frequency sweep, dc bias voltage sweep, or dc bias current sweep.

Parameters

	<b>&lt;numeric&gt;</b>
Description	Oscillator power level
Data type	Floating point
Range	-40 to 1
Default	-13.01
Unit	dBm

If the specified parameter is outside the range, the minimum (if the lower limit of the range is exceeded) or maximum value (if the upper limit is exceeded) will be assumed.

Query response        {numeric}<newline><^END>

Related commands    **SOUR:POW:MODE** command on page 472

Front Panel            **Stimulus - Source...** - OSC Level: dBm  
 Equivalent

## SOUR:POW:CENT

**Format** SOURce:POWer:CENTer <numeric>  
 SOURce:POWer:CENTer?

**Description** Sets the center value in the oscillator power level sweep range.  
 In addition, use the **SOUR:POW:SPAN** command to set the span value of the sweep range.

**Parameters**

	<numeric>
Description	Center value in the sweep range
Data type	Floating point
Range	-40 to 1
Default	-3.9794
Unit	dBm

If the specified parameter is outside the range, the minimum (if the lower limit of the range is exceeded) or maximum value (if the upper limit is exceeded) will be assumed.

**Query response** {numeric}<newline><^END>

**Related commands** **SOUR:POW:MODE** command on page 472  
**SOUR:POW:SPAN** command on page 473

**Front Panel  
 Equivalent** **Stimulus - Start/Stop...** - Center: dBm

## **SOUR:POW:MODE**

Format            SOURce:POWer:MODE {FIXed|SWEep}  
                  SOURce:POWer:MODE?

Description      Selects the oscillator power level mode.

Parameters

	<b>Description</b>
FIXed (Default)	Specifies the fixed power mode.
SWEep	Specifies the power sweep mode.

Query response    {FIX|SWE}<newline><^END>

Related commands **SWE:TYPE** command on page 515  
**SOUR:CURR:MODE** command on page 460  
**SOUR:VOLT:MODE** command on page 479

Front Panel       **Stimulus - Source...** - OSC Unit  
Equivalentents

## SOUR:POW:SPAN

**Format** SOURce:POWer:SPAN <numeric>  
 SOURce:POWer:SPAN?

**Description** Sets the span value in the oscillator power level sweep range.  
 In addition, use the **SOUR:POW:CENT** command to set the center value of the sweep range.

**Parameters**

	<numeric>
Description	Span value in the sweep range
Data type	Floating point
Range	0 to 41
Default	6.0206
Unit	dBm

If the specified parameter is outside the range, the minimum (if the lower limit of the range is exceeded) or maximum value (if the upper limit is exceeded) will be assumed.

**Query response** {numeric}<newline><^END>

**Related commands** **SOUR:POW:MODE** command on page 472  
**SOUR:POW:CENT** command on page 471

**Front Panel Equivalents** **Stimulus - Start/Stop...** - Span: dBm

## SOUR:POW:STAR

Format            SOURce:POWer:STARt <numeric>  
                    SOURce:POWer:STARt?

Description       Sets the start value in the oscillator power level sweep range.  
  
                    In addition, use the **SOUR:POW:STOP** command to set the stop value of the sweep range.

### Parameters

	<numeric>
Description	Start value in the sweep range
Data type	Floating point
Range	-40 to 1
Default	-6.9897
Unit	dBm

If the specified parameter is outside the range, the minimum (if the lower limit of the range is exceeded) or maximum value (if the upper limit is exceeded) will be assumed.

Query response    {numeric}<newline><^END>

Related commands **SOUR:POW:MODE** command on page 472  
**SOUR:POW:STOP** command on page 475

Front Panel       **Stimulus - Start/Stop...** - Start: dBm  
Equivalents

## SOUR:POW:STOP

**Format** SOURce:POWer:STOP <numeric>  
 SOURce:POWer:STOP?

**Description** Sets the stop value in the oscillator power level sweep range.  
 In addition, use the **SOUR:POW:STAR** command to set the start value of the sweep range.

**Parameters**

	<numeric>
Description	Stop value in the sweep range
Data type	Floating point
Range	-40 to 1
Default	-0.9691
Unit	dBm

If the specified parameter is outside the range, the minimum (if the lower limit of the range is exceeded) or maximum value (if the upper limit is exceeded) will be assumed.

**Query response** {numeric}<newline><^END>

**Related commands** **SOUR:POW:MODE** command on page 472  
**SOUR:POW:STAR** command on page 474

**Front Panel Equivalents** **Stimulus - Start/Stop...** - Stop: dBm

## SOUR:VOLT

Format SOURce:VOLTage[:LEVel][:IMMediate][:AMPLitude] <numeric>  
 SOURce:VOLTage[:LEVel][:IMMediate][:AMPLitude]?

Description Sets the oscillator voltage level when the sweep parameter is set to frequency sweep, dc bias voltage sweep, or dc bias current sweep.

### Parameters

	<numeric>
Description	Oscillator voltage level
Data type	Floating point
Range	5E-3 to 502E-3
Default	100E-3
Resolution	1E-3
Unit	V (voltage)

If the specified parameter is outside the range, the minimum (if the lower limit of the range is exceeded) or maximum value (if the upper limit is exceeded) will be assumed.

Query response {numeric}<newline><^END>

Related commands **SOUR:VOLT:MODE** command on page 479

Front Panel **Stimulus - Source...** - OSC Level: V  
Equivalents



## SOUR:VOLT:CENT

**Format** SOURce:VOLTage:CENTer <numeric>  
 SOURce:VOLTage:CENTer?

**Description** Sets the center value in the oscillator voltage level sweep range.  
 In addition, use the **SOUR:VOLT:SPAN** command to set the span value of the sweep range.

**Parameters**

	<numeric>
Description	Center value in the sweep range
Data type	Floating point
Range	5E-3 to 502E-3
Default	300E-3
Resolution	1E-3
Unit	V (volt)

If the specified parameter is outside the range, the minimum (if the lower limit of the range is exceeded) or maximum value (if the upper limit is exceeded) will be assumed.

**Query response** {numeric}<newline><^END>

**Related commands** **SOUR:VOLT:MODE** command on page 479  
**SOUR:VOLT:SPAN** command on page 486

**Front Panel Equivalents** **Stimulus - Start/Stop...** - Center: V

## **SOUR:VOLT:LIM:OFFS**

Format                   SOURce:VOLTage:LIMit:OFFSet <numeric>  
                          SOURce:VOLTage:LIMit:OFFSet?

Description           Sets the maximum value of the dc bias voltage limit when the dc bias output mode is set to current sweep mode or fixed current source mode. This command is available when Option 001 (dc bias function) is installed.

### Parameters

	<b>&lt;numeric&gt;</b>
Description	dc bias voltage limit maximum value
Data type	Floating point
Range	1 to 40
Default	1
Resolution	1E-3
Unit	V (volt)

If the specified parameter is outside the range, the minimum (if the lower limit of the range is exceeded) or maximum value (if the upper limit is exceeded) will be assumed.

Query response       {numeric}<newline><^END>

Front Panel  
Equivalents           **Stimulus - Source...** - Bias Limit: V

## SOUR:VOLT:MODE

Format            SOURce:VOLTage:MODE {FIXed|SWEep}  
 SOURce:VOLTage:MODE?

Description        Selects the oscillator voltage level mode.

Parameters

	Description
FIXed (Default)	Specifies the fixed voltage mode.
SWEep	Specifies the voltage sweep mode.

Query response    {FIX|SWE}<newline><^END>

Related commands **SWE:TYPE** command on page 515  
**SOUR:CURR:MODE** command on page 460  
**SOUR:POW:MODE** command on page 472

Front Panel  
 Equivalents        **Stimulus - Source...** - Osc Unit

## SOUR:VOLT:OFFS

Format                    SOURce:VOLTage[:LEVel][:IMMediate][:AMPLitude]:OFFSet <numeric>  
 SOURce:VOLTage[:LEVel][:IMMediate][:AMPLitude]:OFFSet?

Description             Sets the dc bias voltage level in the fixed voltage source mode. This command can be used when Option 001 (dc bias function) is installed.

### Parameters

	<numeric>
Description	dc bias voltage level
Data type	Floating point
Range	-40 to 40
Default	0
Resolution	1E-3
Unit	V (volt)

If the specified parameter is outside the range, the minimum (if the lower limit of the range is exceeded) or maximum value (if the upper limit is exceeded) will be assumed.

Query response        {numeric}<newline><^END>

Front Panel  
Equivalents            **Stimulus - Source...** - Bias Level: V

## SOUR:VOLT:OFFS:CEN

**Format**                    SOURce:VOLTage[:LEVel][:IMMediate][:AMPLitude]:OFFSet:CENTer <numeric>  
 SOURce:VOLTage[:LEVel][:IMMediate][:AMPLitude]:OFFSet:CENTer?

**Description**            Sets the center value in the dc bias voltage sweep range. This command can be used when Option 001 (dc bias function) is installed.  
  
 In addition, use the **SOUR:VOLT:OFFS:SPAN** command to set the span value of the sweep range.

**Parameters**

	<numeric>
Description	Center value in the sweep range
Data type	Floating point
Range	-40 to 40
Default	0
Resolution	1E-3
Unit	V (volt)

If the specified parameter is outside the range, the minimum (if the lower limit of the range is exceeded) or maximum value (if the upper limit is exceeded) will be assumed.

**Query response**        {numeric}<newline><^END>

**Related commands**    **SOUR:VOLT:OFFS:SPAN** command on page 482

**Front Panel**            **Stimulus - Start/Stop...** - Center: V  
**Equivalents**

## SOUR:VOLT:OFFS:SPAN

**Format** SOURce:VOLTage[:LEVel][:IMMediate][:AMPLitude]:OFFSet:SPAN <numeric>  
 SOURce:VOLTage[:LEVel][:IMMediate][:AMPLitude]:OFFSet:SPAN?

**Description** Sets the span value in the dc bias voltage sweep range. This command can be used when Option 001 (dc bias function) is installed.  
 In addition, use the **SOUR:VOLT:OFFS:CENT** command to set the center value of the sweep range.

### Parameters

	<numeric>
Description	Span value in the sweep range
Data type	Floating point
Range	0 to 80
Default	0
Resolution	1E-3
Unit	V (volt)

If the specified parameter is outside the range, the minimum (if the lower limit of the range is exceeded) or maximum value (if the upper limit is exceeded) will be assumed.

**Query response** {numeric}<newline><^END>

**Related commands** **SOUR:VOLT:OFFS:CENT** command on page 481

**Front Panel  
Equivalents** **Stimulus - Start/Stop...** - Span: V

## SOUR:VOLT:OFFS:STAR

**Format**                    SOURce:VOLTage[:LEVel][:IMMediate][:AMPLitude]:OFFSet:STARt <numeric>  
 SOURce:VOLTage[:LEVel][:IMMediate][:AMPLitude]:OFFSet:STARt?

**Description**            Sets the start value in the dc bias voltage sweep range. This command can be used when Option 001 (dc bias function) is installed.  
  
 In addition, use the **SOUR:VOLT:OFFS:STOP** command to set the stop value of the sweep range.

**Parameters**

	<numeric>
Description	Start value in the sweep range
Data type	Floating point
Range	-40 to 40
Default	0
Resolution	1E-3
Unit	V (volt)

If the specified parameter is outside the range, the minimum (if the lower limit of the range is exceeded) or maximum value (if the upper limit is exceeded) will be assumed.

**Query response**        {numeric}<newline><^END>

**Related commands**    **SOUR:VOLT:OFFS:STOP** command on page 485

**Front Panel Equivalents**    **Stimulus - Start/Stop...** - Start: V

## **SOUR:VOLT:OFFS:STAT**

**Format** SOURce:VOLTage[:LEVel][:IMMediate][:AMPLitude]:OFFSet:STATe {ON|OFF|1|0}  
SOURce:VOLTage[:LEVel][:IMMediate][:AMPLitude]:OFFSet:STATe?

**Description** Turns on/off the dc bias output in the voltage sweep mode or fixed voltage source mode. This command can be used when Option 001 (dc bias function) is installed.

**Parameters**

	<b>Description</b>
ON or 1	Turn on the dc bias output. *1
OFF or 0 (Default)	Turn off the dc bias output.

\*1. When the dc bias output is converted from on to off, the sweep mode is automatically set to hold.

**Query response** {1|0}<newline><^END>

**Related commands** **SOUR:CURR:OFFS:STAT** command on page 465

**Front Panel  
Equivalents** **Stimulus - Source...** - dc bias: [On/Off]



## SOUR:VOLT:OFFS:STOP

**Format**                    SOURce:VOLTage[:LEVel][:IMMediate][:AMPLitude]:OFFSet:STOP <numeric>  
 SOURce:VOLTage[:LEVel][:IMMediate][:AMPLitude]:OFFSet:STOP?

**Description**            Sets the stop value in the dc bias voltage sweep range. This command can be used when Option 001 (dc bias function) is installed.  
  
 In addition, use the **SOUR:VOLT:OFFS:STAR** command to set the start value in the sweep range.

**Parameters**

	<numeric>
Description	Stop value in the sweep range
Data type	Floating point
Range	-40 to 40
Default	0
Resolution	1E-3
Unit	V (volt)

If the specified parameter is outside the range, the minimum (if the lower limit of the range is exceeded) or maximum value (if the upper limit is exceeded) will be assumed.

**Query response**        {numeric}<newline><^END>

**Related commands**    **SOUR:VOLT:OFFS:STAR** command on page 483

**Front Panel Equivalents**    **Stimulus - Start/Stop...** - Stop: V

## SOUR:VOLT:SPAN

Format            SOURce:VOLTage:SPAN <numeric>  
                    SOURce:VOLTage:SPAN?

Description       Sets the span value in the oscillator voltage level sweep range.  
  
                    In addition, use the **SOUR:VOLT:CENT** command to set the center value of the sweep range.

### Parameters

	<numeric>
Description	Span value in the sweep range
Data type	Floating point
Range	0 to 497E-3
Default	200.0E-3
Resolution	1E-3
Unit	V (volt)

If the specified parameter is outside the range, the minimum (if the lower limit of the range is exceeded) or maximum value (if the upper limit is exceeded) will be assumed.

Query response    {numeric}<newline><^END>

Related commands **SOUR:VOLT:MODE** command on page 479  
**SOUR:VOLT:CENT** command on page 477

Front Panel       **Stimulus - Start/Stop...** - Span: V  
Equivalentents

## SOUR:VOLT:STAR

**Format** SOURce:VOLTage:STARt <numeric>  
 SOURce:VOLTage:STARt?

**Description** Sets the start value in the oscillator voltage level sweep range.  
 In addition, use the **SOUR:VOLT:STOP** command to set the stop value in the sweep range.

**Parameters**

	<numeric>
Description	Start value in the sweep range
Data type	Floating point
Range	5E-3 to 502E-3
Default	200E-3
Resolution	1E-3
Unit	V (volt)

If the specified parameter is outside the range, the minimum (if the lower limit of the range is exceeded) or maximum value (if the upper limit is exceeded) will be assumed.

**Query response** {numeric}<newline><^END>

**Related commands** **SOUR:VOLT:MODE** command on page 479  
**SOUR:VOLT:STOP** command on page 488

**Front Panel  
 Equivalents** **Stimulus - Start/Stop...** - Start: V

## SOUR:VOLT:STOP

Format            SOURce:VOLTage:STOP <numeric>  
                    SOURce:VOLTage:STOP?

Description       Sets the stop value in the oscillator voltage level sweep range.  
  
                    In addition, use the **SOUR:VOLT:STAR** command to set the start value in the sweep range.

### Parameters

	<numeric>
Description	Stop value in the sweep range
Data type	Floating point
Range	5E-3 to 502E-3
Default	400E-3
Resolution	1E-3
Unit	V (volt)

If the specified parameter is outside the range, the minimum (if the lower limit of the range is exceeded) or maximum value (if the upper limit is exceeded) will be assumed.

Query response    {numeric}<newline><^END>

Related commands **SOUR:VOLT:MODE** command on page 479  
**SOUR:VOLT:STAR** command on page 487

Front Panel       **Stimulus - Start/Stop...** - Stop: V  
Equivalents

## STAT:OPER?

Format	STATus:OPERation[:EVENT]?
Description	Returns the value of the Operation Status Event register. (Query only) See Figure B-3, “Status Register Structure (1/2),” on page 557, for details of the status register structure. See Table B-3, “Status Bit Definition of Operation Status Event Register,” on page 561 for the bit definition of the Operation Status Event register.
Query response	{numeric}<newline><^END> Returns the integer value.
Related commands	<b>*CLS</b> command on page 279
Front Panel Equivalents	Unavailable.

## STAT:OPER:COND?

Format	STATus:OPERation:CONDition?
Description	Returns the value of the Operation Status Condition register. (Query only) See Figure B-3, “Status Register Structure (1/2),” on page 557, for details of the status register structure.
Query response	{numeric}<newline><^END> Returns the integer value.
Front Panel Equivalents	Unavailable.

## **STAT:OPER:ENAB**

**Format** STATus:OPERation:ENABle <numeric>  
STATus:OPERation:ENABle?

**Description** Sets the value of the Operation Status Enable register.  
See Figure B-3, “Status Register Structure (1/2),” on page 557, for details of the status register structure.

### **Parameters**

	<b>&lt;numeric&gt;</b>
Description	Value of the enable register
Data type	Integer
Range	0 to 32767
Default	0

When the parameter is not within the allowed configuration range, the parameter value will be set to the logical product (AND) of each bit from 32767 (0x7fff).

**Query response** {numeric}<newline><^END>

**Related commands** **STAT:PRES** command on page 493  
**STAT:OPER?** command on page 489

**Front Panel  
Equivalents** Unavailable.

## STAT:OPER:NTR

**Format**                    STATus:OPERation:NTRansition <numeric>  
 STATus:OPERation:NTRansition?

**Description**            Sets the value of the negative transition filter of the Operation Status register.  
 See Figure B-3, “Status Register Structure (1/2),” on page 557, for details of the status register structure.

**Parameters**

	<b>&lt;numeric&gt;</b>
Description	Value of the negative transition filter
Data type	Integer
Range	0 to 32767
Default	0

When the parameter is not within the allowed configuration range, the parameter value will be set to the logical product (AND) of each bit from 32767 (0x7fff).

**Query response**        {numeric}<newline><^END>

**Related commands**    **STAT:PRES** command on page 493  
**STAT:OPER:PTR** command on page 492

**Front Panel  
 Equivalents**            Unavailable.

## **STAT:OPER:PTR**

**Format**                    STATus:OPERation:PTRansition <numeric>  
                             STATus:OPERation:PTRansition?

**Description**            Sets the value of the positive transition filter of the Operation Status register.  
                             See Figure B-3, “Status Register Structure (1/2),” on page 557, for details of the status register structure.

**Parameters**

	<b>&lt;numeric&gt;</b>
Description	Value of the positive transition filter
Data type	Integer
Range	0 to 32767
Default	32767

When the parameter is not within the allowed configuration range, the parameter value will be set to the logical product (AND) of each bit from 32767 (0x7fff).

**Query response**        {numeric}<newline><^END>

**Related commands**    **STAT:PRES** command on page 493  
                             **STAT:OPER:NTR** command on page 491

**Front Panel  
Equivalents**            Unavailable.



## STAT:PRES

Format	STATus:PRESet
Description	Initializes the Operation Status and the Questionable Status. (No query)
Front Panel Equivalents	Unavailable.

## STAT:QUES?

Format	STATus:QUEStionable[:EVENT]?
Description	Returns the value of the Questionable Status Event register. (Query only) See Figure B-3, “Status Register Structure (1/2),” on page 557, for details of the status register structure. See Table B-4, “Status Bit Definition of Questionable Status Event Register,” on page 561 for the bit definition of the Questionable Status Event register.
Query response	{numeric}<newline><^END> Returns the integer value.
Related commands	<b>*CLS</b> command on page 279
Front Panel Equivalents	Unavailable.

## STAT:QUES:COND?

Format	STATus:QUEStionable:CONDition?
Description	Returns the value of the Questionable Status Condition register. (Query only) See Figure B-3, “Status Register Structure (1/2),” on page 557, for details of the status register structure.
Query response	{0}<newline><^END> Returns the value of 0 for all query.
Front Panel Equivalents	Unavailable.

## **STAT:QUES:ENAB**

**Format** STATus:QUEStionable:ENABle <numeric>  
STATus:QUEStionable:ENABle?

**Description** Sets the value of the Questionable Status Enable register.  
See Figure B-3, “Status Register Structure (1/2),” on page 557, for details of the status register structure.

### **Parameters**

	<b>&lt;numeric&gt;</b>
Description	Value of the enable register
Data type	Integer
Range	0 to 32767
Default	0

When the parameter is not within the allowed configuration range, the parameter value will be set to the logical product (AND) of each bit from 32767 (0x7fff).

**Query response** {numeric}<newline><^END>

**Related commands** **STAT:PRES** command on page 493  
**STAT:QUES?** command on page 493

**Front Panel  
Equivalents** Unavailable.

## **STAT:QUES:HARD?**

Format	STATus:QUEStionable:HARDware[:EVENT]?
Description	Returns the value of the Questionable Status Hardware Event register. (Query only) See Figure B-4, “Status Register Structure (2/2),” on page 558, for details of the status register structure. See Table B-5, “Status Bit Definition of Questionable Status Hardware Event Register,” on page 562 for the bit definition of the Questionable Status Hardware Event register.
Query response	{numeric}<newline><^END> Returns the integer value.
Related commands	<b>*CLS</b> command on page 279
Front Panel Equivalents	Unavailable.

## **STAT:QUES:HARD:COND?**

Format	STATus:QUEStionable:HARDware:CONDition?
Description	Returns the value of the Questionable Status Hardware Condition register. (Query only) See Figure B-4, “Status Register Structure (2/2),” on page 558, for details of the status register structure.
Query response	{0}<newline><^END> Returns the value of 0 for all query.
Front Panel Equivalents	Unavailable.

## **STAT:QUES:HARD:ENAB**

**Format**                   STATus:QUEStionable:HARDware:ENABle <numeric>  
STATus:QUEStionable:HARDware:ENABle?

**Description**           Sets the value of the Questionable Status Hardware Enable register.  
See Figure B-4, “Status Register Structure (2/2),” on page 558, for details of the status register structure.

**Parameters**

	<b>&lt;numeric&gt;</b>
Description	Value of the enable register
Data type	Integer
Range	0 to 32767
Default	0

When the parameter is not within the allowed configuration range, the parameter value will be set to the logical product (AND) of each bit from 32767 (0x7fff).

**Query response**       {numeric}<newline><^END>

**Related commands**   **STAT:PRES** command on page 493  
**STAT:QUES:HARD?** command on page 495

**Front Panel  
Equivalents**           Unavailable.

## STAT:QUES:HARD:NTR

**Format**                    STATus:QUEStionable:HARDware:NTRansition <numeric>  
 STATus:QUEStionable:HARDware:NTRansition?

**Description**             Sets the value of the negative transition filter of the Questionable Status Hardware register.  
 See Figure B-4, “Status Register Structure (2/2),” on page 558, for details of the status register structure.

**Parameters**

	<numeric>
Description	Value of the negative transition filter
Data type	Integer
Range	0 to 32767
Default	0

When the parameter is not within the allowed configuration range, the parameter value will be set to the logical product (AND) of each bit from 32767 (0x7fff).

**Query response**        {numeric}<newline><^END>

**Related commands**    **STAT:PRES** command on page 493  
**STAT:QUES:HARD:PTR** command on page 498

**Front Panel  
 Equivalents**            Unavailable.

## **STAT:QUES:HARD:PTR**

**Format**                    STATus:QUEStionable:HARDware:PTRansition <numeric>  
                             STATus:QUEStionable:HARDware:PTRansition?

**Description**            Sets the value of the positive transition filter of the Questionable Status Hardware register.  
                             See Figure B-4, “Status Register Structure (2/2),” on page 558, for details of the status register structure.

**Parameters**

	<b>&lt;numeric&gt;</b>
Description	Value of the positive transition filter
Data type	Integer
Range	0 to 32767
Default	32767

When the parameter is not within the allowed configuration range, the parameter value will be set to the logical product (AND) of each bit from 32767 (0x7fff).

**Query response**        {numeric}<newline><^END>

**Related commands**    **STAT:PRES** command on page 493  
**STAT:QUES:HARD:NTR** command on page 497

**Front Panel  
Equivalents**            Unavailable.

## STAT:QUES:LIM?

Format	STATus:QUEStionable:LIMit[:EVENT]?
Description	Returns the value of the Questionable Status Limit Event register. (Query only) See Figure B-4, “Status Register Structure (2/2),” on page 558, for details of the status register structure. See Table B-6, “Status Bit Definition of Questionable Status Limit Event Register,” on page 562 for the bit definition of the Questionable Status Limit Event register.
Query response	{numeric}<newline><^END> Returns the integer value.
Related commands	<b>*CLS</b> command on page 279
Front Panel Equivalents	Unavailable.

## STAT:QUES:LIM:COND?

Format	STATus:QUEStionable:LIMit:CONDition?
Description	Returns the value of the Questionable Status Limit Condition register. (Query only) See Figure B-4, “Status Register Structure (2/2),” on page 558, for details of the status register structure.
Query response	{0}<^END> Returns the value of 0 for all query.
Front Panel Equivalents	Unavailable.

## STAT:QUES:LIM:ENAB

Format                    STATus:QUEStionable:LIMit:ENABle <numeric>  
                            STATus:QUEStionable:LIMit:ENABle?

Description             Sets the value of the Questionable Status Limit Enable register.  
  
                            See Figure B-4, “Status Register Structure (2/2),” on page 558, for details of the status register structure.

### Parameters

	<numeric>
Description	Value of the enable register
Data type	Integer
Range	0 to 32767
Default	0

When the parameter is not within the allowed configuration range, the parameter value will be set to the logical product (AND) of each bit from 32767 (0x7fff).

Query response        {numeric}<newline><^END>

Related commands    **STAT:PRES** command on page 493  
                            **STAT:QUES:LIM?** command on page 499

Front Panel  
Equivalents            Unavailable.



## STAT:QUES:LIM:NTR

**Format**                    STATus:QUEStionable:LIMit:NTRansition <numeric>  
 STATus:QUEStionable:LIMit:NTRansition?

**Description**            Sets the value of the negative transition filter of the Questionable Status Limit register.  
 See Figure B-4, “Status Register Structure (2/2),” on page 558, for details of the status register structure.

**Parameters**

	<b>&lt;numeric&gt;</b>
Description	Value of the negative transition filter
Data type	Integer
Range	0 to 32767
Default	0

When the parameter is not within the allowed configuration range, the parameter value will be set to the logical product (AND) of each bit from 32767 (0x7fff).

**Query response**        {numeric}<newline><^END>

**Related commands**    **STAT:PRES** command on page 493  
**STAT:QUES:LIM:PTR** command on page 502

**Front Panel  
 Equivalents**            Unavailable.

## **STAT:QUES:LIM:PTR**

**Format**                    STATus:QUEStionable:LIMit:PTRansition <numeric>  
                              STATus:QUEStionable:LIMit:PTRansition?

**Description**            Sets the value of the positive transition filter of the Questionable Status Limit register.  
                              See Figure B-4, “Status Register Structure (2/2),” on page 558, for details of the status register structure.

**Parameters**

	<b>&lt;numeric&gt;</b>
Description	Value of the positive transition filter
Data type	Integer
Range	0 to 32767
Default	32767

When the parameter is not within the allowed configuration range, the parameter value will be set to the logical product (AND) of each bit from 32767 (0x7fff).

**Query response**        {numeric}<newline><^END>

**Related commands**    **STAT:PRES** command on page 493  
                              **STAT:QUES:LIM:NTR** command on page 501

**Front Panel  
Equivalents**            Unavailable.

## STAT:QUES:NTR

**Format**                    STATus:QUEStionable:NTRansition <numeric>  
 STATus:QUEStionable:NTRansition?

**Description**            Sets the value of the negative transition filter of the Questionable Status register.  
 See Figure B-4, “Status Register Structure (2/2),” on page 558, for details of the status register structure.

**Parameters**

	<b>&lt;numeric&gt;</b>
Description	Value of the negative transition filter
Data type	Integer
Range	0 to 32767
Default	0

When the parameter is not within the allowed configuration range, the parameter value will be set to the logical product (AND) of each bit from 32767 (0x7fff).

**Query response**        {numeric}<newline><^END>

**Related commands**    **STAT:PRES** command on page 493  
**STAT:QUES:PTR** command on page 504

**Front Panel  
 Equivalents**            Unavailable.

## STAT:QUES:PTR

**Format**                    STATus:QUEStionable:PTRansition <numeric>  
                               STATus:QUEStionable:PTRansition?

**Description**            Sets the value of the positive transition filter of the Questionable Status register.  
                               See Figure B-4, “Status Register Structure (2/2),” on page 558, for details of the status register structure.

**Parameters**

	<b>&lt;numeric&gt;</b>
Description	Value of the positive transition filter
Data type	Integer
Range	0 to 32767
Default	32767

When the parameter is not within the allowed configuration range, the parameter value will be set to the logical product (AND) of each bit from 32767 (0x7fff).

**Query response**        {numeric}<newline><^END>

**Related commands**    **STAT:PRES** command on page 493  
                               **STAT:QUES:NTR** command on page 503

**Front Panel  
 Equivalents**            Unavailable.

## STAT:QUES:SEAR?

**Format**                    STATus:QUEStionable:SEARch[:EVENT]?

**Description**            Returns the value of the Questionable Status Search Event register. (Query only)  
                               See Figure B-4, “Status Register Structure (2/2),” on page 558, for details of the status register structure.  
                               See Table B-7, “Status Bit Definition of Questionable Status Search Event Register,” on page 563 for the bit definition of the Questionable Status Search Event register.

**Query response**        {numeric}<newline><^END>  
                               Returns the integer value.

**Related commands**    **\*CLS** command on page 279

**Front Panel  
 Equivalents**            Unavailable.

## STAT:QUES:SEAR:COND?

Format	STATus:QUEStionable:SEARch:CONDition?
Description	Returns the value of the Questionable Status Search Condition register. (Query only) See Figure B-4, “Status Register Structure (2/2),” on page 558, for details of the status register structure.
Query response	{0}<newline><^END> Returns 0 for all query.
Front Panel Equivalents	Unavailable.

## STAT:QUES:SEAR:ENAB

Format	STATus:QUEStionable:SEARch:ENABle <numeric> STATus:QUEStionable:SEARch:ENABle?
Description	Sets the value of the Questionable Status Search Enable register. See Figure B-4, “Status Register Structure (2/2),” on page 558, for details of the status register structure.
Parameters	

	<numeric>
Description	Value of the enable register
Data type	Integer
Range	0 to 32767
Default	0

When the parameter is not within the allowed configuration range, the parameter value will be set to the logical product (AND) of each bit from 32767 (0x7fff).

Query response	{numeric}<newline><^END>
Related commands	<b>STAT:PRES</b> command on page 493 <b>STAT:QUES:SEAR?</b> command on page 504
Front Panel Equivalents	Unavailable.

## **STAT:QUES:SEAR:NTR**

**Format**                    STATus:QUEStionable:SEARch:NTRansition <numeric>  
                             STATus:QUEStionable:SEARch:NTRansition?

**Description**            Sets the value of the negative transition filter of the Questionable Status Search register.  
                             See Figure B-4, “Status Register Structure (2/2),” on page 558, for details of the status register structure.

**Parameters**

	<b>&lt;numeric&gt;</b>
Description	Value of the negative transition filter
Data type	Integer
Range	0 to 32767
Default	0

When the parameter is not within the allowed configuration range, the parameter value will be set to the logical product (AND) of each bit from 32767 (0x7fff).

**Query response**        {numeric}<newline><^END>

**Related commands**    **STAT:PRES** command on page 493  
**STAT:QUES:SEAR:PTR** command on page 507

**Front Panel  
Equivalents**            Unavailable.

## STAT:QUES:SEAR:PTR

**Format**                    STATus:QUEStionable:SEARch:PTRansition <numeric>  
 STATus:QUEStionable:SEARch:PTRansition?

**Description**            Sets the value of the positive transition filter of the Questionable Status Search register.  
 See Figure B-4, “Status Register Structure (2/2),” on page 558, for details of the status register structure.

**Parameters**

	<numeric>
Description	Value of the positive transition filter
Data type	Integer
Range	0 to 32767
Default	32767

When the parameter is not within the allowed configuration range, the parameter value will be set to the logical product (AND) of each bit from 32767 (0x7fff).

**Query response**        {numeric}<newline><^END>

**Related commands**    **STAT:PRES** command on page 493  
**STAT:QUES:SEAR:NTR** command on page 506

**Front Panel  
 Equivalents**            Unavailable.

## SWE:DIR

**Format** [SENSe:]SWEep:DIRection {UP|DOWN}  
 [SENSe:]SWEep:DIRection?

**Description** Selects the direction of the sweep.

**Parameters**

	Description
UP (Default)	Specifies the direction toward the increasing stimulus value.
DOWN	Specifies the direction toward the decreasing stimulus value.

**Query response** {UP|DOWN}<newline><^END>

**Front Panel  
Equivalents** **Stimulus - Sweep Setup...** - Sweep Direction: [Up/Down]

## SWE:DWEL1

**Format** [SENSe:]SWEep:DWEL11 <numeric>  
 [SENSe:]SWEep:DWEL11?

**Description** Sets the delay time for each sweep. In addition, when automatic sweep time is set to auto with the **SWE:TIME:AUTO** command, the delay time is reset to 0 second.

**Parameters**

	<numeric>
Description	Delay time
Data type	Floating point
Range	0 to 20
Default	0
Resolution	1E-4
Unit	s (seconds)

If the specified parameter is outside the range, the minimum (if the lower limit of the range is exceeded) or maximum value (if the upper limit is exceeded) will be assumed.

**Query response** {numeric}<newline><^END>

**Related commands** **SWE:TIME:AUTO** command on page 514

**Front Panel  
Equivalents** **Stimulus - Sweep Setup...** - Sweep Time: [Auto/Manual] - Sweep Delay



## SWE:DWEL2

Format [SENSe:]SWEep:DWEL12 <numeric>  
 [SENSe:]SWEep:DWEL12?

Description Sets the delay time for each measurement point. In addition, when automatic sweep time is set to auto with the **SWE:TIME:AUTO** command, the delay time is reset to 0 second.

### Parameters

	<numeric>
Description	Delay time
Data type	Floating point
Range	0 to 20
Default	0
Resolution	1E-4
Unit	s (seconds)

If the specified parameter is outside the range, the minimum (if the lower limit of the range is exceeded) or maximum value (if the upper limit is exceeded) will be assumed.

Query response {numeric}<newline><^END>

Related commands **SWE:TIME:AUTO** command on page 514

Front Panel Equivalents **Stimulus - Sweep Setup...** - Sweep Time: [Auto/Manual] - Point Delay

## **SWE:DWEL3**

Format [SENSe:]SWEep:DWEL3 <numeric>  
[SENSe:]SWEep:DWEL3?

Description Sets the delay time for each segment in the segment sweep mode. In addition, when automatic sweep time is set to auto with the **SWE:TIME:AUTO** command, the delay time is reset to 0 second.

### Parameters

	<b>&lt;numeric&gt;</b>
Description	Delay time
Data type	Floating point
Range	0 to 20
Default	0
Resolution	1E-4
Unit	s (seconds)

If the specified parameter is outside the range, the minimum (if the lower limit of the range is exceeded) or maximum value (if the upper limit is exceeded) will be assumed.

Query response {numeric}<newline><^END>

Related commands **SWE:TIME:AUTO** command on page 514

Front Panel **Stimulus - Sweep Setup...** - Sweep Time: [Auto/Manual] - Segment Delay  
Equivalentents

## SWE:POIN

Format [SENSe:]SWEep:POINts <numeric>  
[SENSe:]SWEep:POINts?

Description Sets the number of points measured at each sweep.

Parameters

	<numeric>
Description	Number of points
Data type	Integer
Range	2 to 801
Default	201

If the specified parameter is outside the range, the minimum (if the lower limit of the range is exceeded) or maximum value (if the upper limit is exceeded) will be assumed.

Query response {numeric}<newline><^END>

Front Panel Equivalents **Stimulus - Sweep Setup...** - Number Of Points

## **SWE:STIM{1-4}?**

Format [SENSe:]SWEep:STIMulus{1-4}?

Description Reads the stimulus value at all measurement points. (Query only)

Parameters

Sub-block	Description
STIMulus1	Specifies the stimulus value at the frequency sweep.
STIMulus2	Specifies the stimulus value at the oscillator level sweep.
STIMulus3 <sup>*1</sup>	Specifies the stimulus value at the dc bias voltage sweep.
STIMulus4 <sup>*1</sup>	Specifies the stimulus value at the dc bias current sweep.

\*1. This can be used when Option 001 (dc bias function) is installed.

Query response {numeric 1}, {numeric 2},..., {numeric N-1}, {numeric N}<newline><<^END>

Where N is the number of measurement points.

Floating point type numeric is sensed.

Related commands **FORM:DATA** command on page 374

Front Panel Unavailable.  
Equivalents

## SWE:TIME

Format [SENSe:]SWEep:TIME <numeric>  
 [SENSe:]SWEep:TIME?

Description Sets the sweep time.

Parameters

	<numeric>
Description	Sweep time
Data type	Floating point
Range	0 to approximately. (Nop × 20)
Default	1.45
Resolution	1E-4
Unit	s (seconds)

If the specified parameter is outside the range, the minimum (if the lower limit of the range is exceeded) or maximum value (if the upper limit is exceeded) will be assumed.

Query response {numeric}<newline><^END>

Related commands **SWE:TIME:AUTO** command on page 514

Front Panel Equivalents **Stimulus - Sweep Setup...** - Sweep Time: [Auto/Manual] - Sweep Time

## **SWE:TIME:AUTO**

Format [SENSe:]SWEep:TIME:AUTO {ON|OFF|1|0}  
[SENSe:]SWEep:TIME:AUTO?

Description Selects the automatic sweep time either by auto setting or by manual setting.

Parameters

	<b>Description</b>
ON or 1 (Default)	Specifies the auto setting <sup>*1</sup> .
OFF or 0	Specifies the manual setting <sup>*2</sup> .

\*1. The shortest sweep time is set of the present setting of E4991A.

\*2. By using the **SWE:TIME** command, sets the sweep time.

Query response {1|0}<newline><^END>

Related commands **SWE:TIME** command on page 513

Front Panel **Stimulus - Sweep Setup...** - Sweep Time: [Auto/Manual]  
Equivalentents

## SWE:TYPE

**Format** [SENSe:]SWEep:TYPE {LINear|LOGarithmic|SEGment|POWer|DCV|DCI}  
 [SENSe:]SWEep:TYPE?

**Description** Selects the sweep parameter (sweep type).

**Parameters**

	Description
LINear (Default)	Specifies the frequency sweep (linear sweep).
LOGarithmic	Specifies the frequency sweep (log sweep).
SEGment <sup>*1</sup>	Specifies the frequency sweep (segment sweep).
POWer	Specifies the oscillator level sweep (linear sweep).
DCV <sup>*2</sup>	Specifies the dc bias voltage sweep (linear sweep).
DCI <sup>*2</sup>	Specifies the dc bias current sweep (linear sweep).

\*1. In order to set the segment sweep, it is necessary to create the segment sweep table in advance.

\*2. This can be used when Option 001 (dc bias function) is installed.

**Query response** {LIN|LOG|SEGM|POW|DCV|DCI}<newline><^END>

**Front Panel Equivalents** **Stimulus - Sweep Setup...** - Sweep Parameter|Sweep Type

## **SYST:BEEP**

Format	SYSTem:BEEPer[:IMMEDIATE]
Description	Produces a beep sound. (No query)
Front Panel Equivalents	Unavailable.

## **SYST:BEEP:STAT**

Format	SYSTem:BEEPer:STATe {ON OFF 1 0} SYSTem:BEEPer:STATe?
Description	Turns on/off the beep output.
Parameters	

	<b>Description</b>
ON or 1 (Default)	Enables the beep sound.
OFF or 0	Disables the beep sound.

Query response	{1 0}<newline><^END>
Front Panel Equivalents	<b>System - System...</b> - Beep: [On/Off]



## SYST:DATE

Format SYSTem:DATE <numeric 1>,<numeric 2>,<numeric 3>  
 SYSTem:DATE?

Description Sets date.

Parameters

	<numeric 1>	<numeric 2>	<numeric 3>
Description	year	month	day
Data type	Integer	Integer	Integer
Range	1980 to 2099	1 to 12	1 to 31

When the specified parameter is not within the valid configuration range, an error will occur and the command will be ignored.

Query response {numeric 1},{numeric 2},{numeric 3}<newline><^END>

Related commands **SYST:TIME** on page 524

Front Panel Equivalents see *Operation Manual*.

## SYST:ERR?

Format SYSTem:ERRor?

Description Returns the oldest error stored in the error cue. When the **\*CLS** command is executed, errors stored in the error cue are cleared. (Query only)

Query response {numeric},{string}<newline><^END>

	<numeric>	<string>
Description	error number	error message (string character with double quotation)
Data type	Integer	none

Related commands **SYST:ERR:COUN?** command on page 518  
**\*CLS** command on page 279

Front Panel Equivalents Unavailable.

## **SYST:ERR:COUN?**

**Format** SYSTem:ERRor:COUNT?

**Description** Returns number of errors stored in the error cue. (Query only)

**Query response** {numeric}<newline><^END>  
Returns the integer value.

**Related commands** **SYST:ERR?** command on page 517

**Front Panel  
Equivalents** Unavailable.

## **SYST:EXTR?**

**Format** SYSTem:EXTRef?

**Description** Returns whether an external reference signal is being received from the external reference signal input connector located in the rear panel. (Query only)

**Query response** {1|0}<newline><^END>

	<b>Description</b>
1	External reference signal is being received.
0	External reference signal is not being received.

**Front Panel  
Equivalents** Unavailable.

## SYST:IND:POIN:SET

**Format** SYSTem:INDex:POINt:SET  
 SYSTem:INDex:POINt:SET?

**Description** Sets the timing of the measurement index signal for every measurement point.

**Query response** {1|0}<newline><^END>

	Description
1	The timing of the measurement index signal for every measurement is being selected.
0 (Default)	The timing of the measurement index signal for every measurement is not being selected.

**Related commands** **SYST:IND:SWE:SET** command on page 519  
**SYST:IND:TIME:SET** command on page 521

**Front Panel Equivalents** **System - Diagnostic - Properties...** - At Point

## SYST:IND:SWE:SET

**Format** SYSTem:INDex:SWEEP:SET  
 SYSTem:INDex:SWEEP:SET?

**Description** Sets the timing of the measurement index signal for every sweep.

**Query response** {1|0}<newline><^END>

	Description
1	The timing of the measurement index signal for every sweep is being selected.
0 (Default)	The timing of the measurement index signal for every sweep is not being selected.

**Related commands** **SYST:IND:POIN:SET** command on page 519  
**SYST:IND:TIME:SET** command on page 521

**Front Panel Equivalents** **System - Diagnostic - Properties...** - At Only Sweep End

## **SYST:IND:TIME**

Format           SYSTem:INDex:TIME <numeric>  
                  SYSTem:INDex:TIME?

Description       Sets the amount of time between internal measurement and trace display when setting the timing of the measurement index signal.

### Parameters

	<b>&lt;numeric&gt;</b>
Description	Timing of the measurement index signal
Data type	Floating point
Range	0.001 to 5
Default	0.3
Resolution	0.001
Unit	s (seconds)

Query response   {numeric}<newline><^END>

Related commands **SYST:IND:TIME:SET** command on page 521

Front Panel       **System - Diagnostic - Properties...** - Timer Index Interval Time  
Equivalents

## SYST:IND:TIME:SET

Format	SYSTem:INDex:TIME:SET SYSTem:INDex:TIME:SET?
Description	Allows the user to set the amount of time between internal measurement and trace display when setting the timing of the measurement index signal.
Query response	{1 0}<newline><^END>

	Description
1(Default)	The timing of the measurement index signal is being selected.
0	The timing of the measurement index signal is not being selected.

Related commands	<b>SYST:IND:TIME</b> command on page 520 <b>SYST:IND:POIN:SET</b> command on page 519 <b>SYST:IND:SWE:SET</b> command on page 519
Front Panel Equivalents	<b>System - Diagnostic - Properties...</b> - At Time

## SYST:KLOC

Format            SYSTem:KLOCK[:FPANel] {ON|OFF|1|0}  
                    SYSTem:KLOCK[:FPANel]?

Description       Specifies whether to lock the front panel keys and rotary knob.

Parameters

	Description
ON or 1	Front panel keys and rotary knob locked
OFF or 0 (Default)	Front panel keys and rotary knob unlocked

Query response    {1|0}<newline><^END>

Related commands **SYST:KLOC:KBD** command on page 522  
**SYST:KLOC:MOUS** command on page 523

Front Panel  
Equivalents       Unavailable.

## SYST:KLOC:KBD

Format            SYSTem:KLOCK:KBD {ON|OFF|1|0}  
                    SYSTem:KLOCK:KBD?

Description       Specifies whether to lock the keyboard.

Parameters

	Description
ON or 1	Keyboard locked
OFF or 0 (Default)	Keyboard unlocked

Query response    {1|0}<newline><^END>

Related commands **SYST:KLOC** command on page 522  
**SYST:KLOC:MOUS** command on page 523

Front Panel  
Equivalents       Unavailable.

## SYST:KLOC:MOUS

Format SYSTem:KLOCK:MOUSe {ON|OFF}1|0}  
 SYSTem:KLOCK:MOUSe?

Description Specifies whether to lock the mouse.

Parameters

	Description
ON or 1	Mouse locked
OFF or 0 (Default)	Mouse unlocked

Query response {1|0}<newline><^END>

Related commands **SYST:KLOC** command on page 522  
**SYST:KLOC:KBD** command on page 522

Front Panel Equivalents Unavailable.

## SYST:POFF

Format SYSTem:POFF

Description Turns E4991A's main power off. (No query)

Front Panel Equivalents Standby switch.

## SYST:PRES

Format SYSTem:PRESet

Description Resets the E4991A to its initial settings. Resetting the E4991A by using the **\*RST** command provides basically the same function except for the points below.

- Continuous initialization of the trigger system is set to ON.
- Settings of data transfer format are not changed.

Related commands **\*RST** command on page 282

Front Panel Equivalents **[Preset]** key

## SYST:TIME

Format            SYSTem:TIME <numeric 1>,<numeric 2>,<numeric 3>  
                    SYSTem:TIME?

Description       Sets time of internal clock.

Parameters

	<numeric 1>	<numeric 2>	<numeric 3>
Description	hour (24 hour format)	minute	second
Data type	Integer	Integer	Integer
Range	0 to 23	0 to 59	0 to 59

When the specified parameter is not within the valid configuration range, an error will occur and the command will be ignored.

Query response    {numeric 1},{numeric 2},{numeric 3}<newline><^END>

Related commands **SYST:DATE** on page 517

Front Panel  
Equivalents       see *Operation Manual*.

## SYST:VERS?

Format            SYSTem:VERSion?

Description       Returns the SCPI compliant version. (Query only)

Query response    {string}<newline><^END>

The returned string characters are formatted as “1997.0”. 1997 in the format represents the release year of the version, and 0 represents the version number of that year.

Front Panel  
Equivalents       Unavailable.



## TRIG

Format	TRIGger[:SEQuence][:IMMediate]
Description	The trigger system immediately triggers and executes measurements during the trigger event detection state. An error will occur if the trigger sequence is not in the trigger event detection state. (No query)
Front Panel Equivalents	Unavailable.

## TRIG:EVEN

Format	TRIGger[:SEQuence]:EVENT[:TYPe] {SWEep POINt SEGMent} TRIGger[:SEQuence]:EVENT[:TYPe]?
Description	Selects the detection point of trigger events.
Parameters	

	Description
SWEep*1 (Default)	When a trigger event is detected, a sweep is executed once.
POINt	When a trigger event is detected, measurements are carried out at each measurement point. Therefore, detection of trigger events must be executed as many times as the number of measurement points before a sweep is completed.
SEGMent	When a trigger event is detected during a segment sweep, the sweep is executed according to the sweep setting of the segment. Therefore, the number of detected trigger events must equal the number of segments before a sweep is completed for all of the segments of the list sweep table.

\*1. When Internal Trigger is selected, SWEep is selected automatically.

Query response	{SWE POIN SEGM}<newline><<^END>
Related commands	<b>TRIG:SOUR</b> on page 526
Front Panel Equivalents	<b>Trigger - Trigger Setup... - Trigger Event</b>

## TRIG:SLOP

Format TRIGger[:SEQuence]:SLOPe {POSitive|NEGative}  
 TRIGger[:SEQuence]:SLOPe?

Description Selects the polarity of the trigger signal that is to be received by the external trigger input connector, located on the rear panel. When set to positive, a trigger is executed when the signal changes from a low level to a high level. When set to negative, a trigger is executed by the opposite signal level change direction.

### Parameters

	Description
POSitive (Default)	Specifies positive (trigger is executed when the signal changes from a low level to a high level).
NEGative	Specifies negative (trigger is executed when the signal changes from a high level to a low level).

Query response {POS|NEG}<newline><^END>

Front Panel  
 Equivalent **Trigger - Trigger Setup...** - Trigger Polarity: [Negative/Positive]

## TRIG:SOUR

Format TRIGger[:SEQuence]:SOURce {INTernal|MANual|EXTernal|BUS}  
 TRIGger[:SEQuence]:SOURce?

Description Selects the trigger source.

### Parameters

	Description
INTernal (Default)	Specifies an internal trigger.
MANual	Specifies a manual trigger (operated by the front panel key).
EXTernal	Specifies an external trigger (received by the EXT TRIGGER connector on the rear panel).
BUS	Specifies the GPIB trigger (trigger operated by execution of <b>*TRG</b> command).

Query response {INT|MAN|EXT|BUS}<newline><^END>

Front Panel  
 Equivalent **Trigger - Trigger Setup...** - Trigger Source

---

**18****COM Interface Reference**

This chapter gives COM interface references of the Agilent E4991A classified according to object.

---

## Conventions of COM Interface

### Explanation

The section titled “Explanation” describes the method of controlling the E4991A with the COM interface.

### VB Syntax

The section titled “VB Syntax” describes the format to use for writing programs in Visual Basic.

### Parameter

The section titled “Parameter” describes the parameters required for the methods of COM object.

### Data types

Generally, the following data types can be used for the variables of an argument in COM object. The data type of each variable can be declared before using the variable. If the data type of a variable is not declared, it automatically becomes variant.

Data type	Name	Memory requirement	Range
Integer	Integer type	2 bytes	-32768 to 32767
Long	Long integer type	4 bytes	-2147483648 to 2147483647
Single	Single precision floating-point type	4 bytes	<ul style="list-style-type: none"><li>In the case of negative value -3.402823E38 to -1.401298E-45</li><li>In the case of positive value 1.401298E-45 to 3.402823E38</li></ul>
Double	Double precision floating-point type	8 bytes	<ul style="list-style-type: none"><li>In the case of negative value -1.79769313486232E308 to -4.94065645841247E-324</li><li>In the case of positive value -1.79769313486232E308 to -4.94065645841247E-324</li></ul>
Boolean	Boolean type	2 bytes	1 (True) or 0 (false)

Data type	Name	Memory requirement	Range
String (BSTR)	String type	1 byte/character (alphanumeric)	<ul style="list-style-type: none"> <li>Fixed-length character Declaration of the number of characters is required.</li> <li>Variable-length character Maximum of about 64,000 characters</li> </ul>
Object	Object type	4 bytes	Browsing object of choice
Variant	Variant type	16 bytes	No limitation

### Response

The section titled “Response” describes the format of data to be read when the “Read” function (reading data) of COM object is possible.

### Examples

The section titled “Examples” gives examples of programming using Visual Basic.

## Application object

This section explains Application object.

### Name property

<b>Explanation</b>	Reads application name (Read only).
<b>VB syntax</b>	Application.Name or Name
<b>Response</b>	Reading in string type. Always "E4991A".
<b>Examples</b>	The following is a program example of reading the application name and displaying it in the message box.

**Example 18-1**      **Example of using Name property**

```
Dim Name As String
Name = Application.Name
MsgBox "Application Name : " & Name
```

### VBAVersion property

<b>Explanation</b>	Reads the version of the E4991AVBA. (Read only)
<b>VB syntax</b>	Application.VBAVersion or VBAVersion
<b>Response</b>	Reading in string type.
<b>Examples</b>	The following is a program example of reading the version of the E4991A VBA and displaying it in the message box.

**Example 18-2**      **Example of using VBAVersion property**

```
Dim Version As String
Version = Application.VBAVersion
MsgBox "VBA Version : " & Version
```

**Connection** property

**Explanation** Reads whether a personal computer is connected to the E4991A by using the E4991A remote user interface function. When this COM object is executed by the installed E4991A VBA, it will always read 1. (Read only)

**VB syntax** Application.Connection  
or  
Connection

**Response** Value of long integer type (1 or 0) is sent back.

1	Connected to the E4991A
0	Not connected to the E4991A

**Examples** The following is a program example of checking whether the E4991A is accessible from a personal computer.

**Example 18-3** Example of using **Connection** property

```
Dim Connection As Long
Connection = Application.Connection
If Connection = 1 Then
    MsgBox "Remote U/I function is available."
ElseIf Connection = 0 Then
    MsgBox "Remote U/I function is not available."
End If
```

## SingleMeasure method

**Explanation** Executes sweep under current setting once and waits for the completion of the sweep. If sweep averaging is enabled, sweep is performed the same number of times as that of the sweep averaging factor. This method sends a response back.

**VB syntax** Application.SingleMeasure  
or  
SingleMeasure

**Response** Value of long integer type (1 or 0) is sent back.

1	Sweep was completed.
0	Sweep was interrupted.

**Examples** The following is a program example of performing the sweep once after the DUT is connected and then giving notification of the completion of the sweep.

**Example 18-4** **Example of using SingleMeasure method**

```
Dim Bool As Long
MsgBox "Connect DUT to Test Fixture"
Bool = Application.SingleMeasure
If Bool = 1 Then
    MsgBox "Sweep Done!"
ElseIf Bool = 0 Then
    MsgBox "Sweep Aborted!"
End If
```



## CalMeasure method

**Explanation** Measures calibration data (Open/Short/Load/Low-loss capacitor) and waits for the completion of measurement. This method sends a response back.

**VB syntax** Application.CalMeasure(CalType)  
or  
CalMeasure(CalType)

**Parameter** CalType: To be selected from the following.

CalOpen	Specifies measurement of Open calibration data
CalShort	Specifies measurement of Short calibration data
CalLoad	Specifies measurement of Load calibration data
CalLowLossC	Specifies measurement of Low-loss capacitor calibration data

**Response** Value of long integer type (1 or 0) is sent back.

1	Measurement of each standard's calibration data was completed.
0	Measurement was interrupted.

**Examples** The following is a program example of indicating the completion of measurement after connecting the open standard of the calibration kit to the 7-mm terminal and measuring the calibration data.

### Example 18-5 Example of using CalMeasure method

```
Dim Bool As Long
MsgBox "Connect OPEN Standard to 7mm Terminal"
Bool = Application.CalMeasure(CalOpen)
If Bool = 1 Then
    MsgBox "OPEN Calibration Done!"
ElseIf Bool = 0 Then
    MsgBox "OPEN Calibration Aborted!"
End If
```

## CompenMeasure method

**Explanation** Measures fixture compensation data (Open/Short) and waits for the completion of measurement. This method sends a response back.

**VB syntax** Application.CompenMeasure(CompenType)  
or  
CompenMeasure(CompenType)

**Parameter** CompenType: To be select from the following.

CompenOpen	Specifies measurement of Open compensation data.
CompenShort	Specifies measurement of Short compensation data.

**Response** Value of long integer type (1 or 0) is sent back.

1	Measurement was completed.
0	Measurement was interrupted.

**Examples** The following is a program example of indicating the completion of measurement after connecting the open standard of the fixture compensation kit to the test fixture and performing the measurement.

**Example 18-6** **Example of using CompenMeasure method**

```
Dim Bool As Long
MsgBox "Connect OPEN Compen Standard to Test Fixture"
Bool = Application.CompenMeasure(CompenOpen)
If Bool = 1 Then
    MsgBox "OPEN Compensation Done!"
ElseIf Bool = 0 Then
    MsgBox "OPEN Compensation Aborted!"
End If
```

## GetTextData method

**Explanation** Copies main setting parameters or measurement data of the E4991A to the clipboard in CSV format in order to paste them into an application like Microsoft Word or Microsoft Excel. This method can be performed by a personal computer that uses the E4991A remote user interface function.

**VB syntax** Application.GetTextData(DataName)  
or  
GetTextData(DataName)

**Parameter** DataName: To be selected from the following.

OperatingParameters	Specifies setting parameters of the E4991A.
ListValues	Specifies measurement data.

**Examples** The following is a program example of copying measurement data onto the clipboard in CSV format.

**Example 18-7** **Example of using GetTextData method**

```
Application.GetTextData (ListValues)
```

## GetScreenImage method

**Explanation** Copies the screen image to the clipboard in the specified file format in order to paste it into an application like Microsoft Word or Microsoft Excel. This method can be performed by a personal computer that uses the E4991A remote user interface function.

**VB syntax** Application.GetScreenImage (ImageForm)  
or  
GetScreenImage (ImageForm)

**Parameter** ImageForm: To be selected from the following.

BMP	Specifies the bitmap format.
JPG	Specifies the JPEG format.

**Examples** The following is a program example of copying the screen display to the clipboard in the bitmap format.

**Example 18-8** **Example of using GetScreenImage method**

```
Application.GetScreenImage (BMP)
```

## WaitForEvent method

**Explanation** Waits for the occurrence of a specified event for the specified period of time. This method sends a response back.

**VB syntax** Application.WaitForEvent(EventName, MaxTime)  
or  
WaitForEvent(EventName, MaxTime)

**Parameter** EventName: To be selected from the following events.

SweepEnd	Specifies the completion of sweep.
SweepStart	Specifies the start of sweep.
CompleteSweepAveraging	Specifies the completion of specified number of sweep averaging.
WaitForTrigger	Specifies the status of waiting for trigger

MaxTime: Specifies maximum time to wait for occurrence of the event

Value type	Long integer type
Range	0 to 1E6
Unit	s (seconds)

**Response** Value of long integer type (1 or 0) is sent back.

1	Specified event was received within specified time.
0	Specified event was not received within specified time and it resulted in time-out.

**Examples** The following is an example of displaying a message when the trigger-waiting status does not occur 10 seconds after confirming that the trigger system is in trigger waiting status.

**Example 18-9** **Example of using WaitForEvent method**

```
Dim Bool As Long
Bool = Application.WaitForEvent(WaitForTrigger, 10)
If Bool = 0 Then
    MsgBox "Time Out occured"
End If
```

**SweepEnd** event

**Explanation** Indicates specified sweep (measurement) is completed.

**Parameter** SweepMode: To be selected from the following.

Measure	Specifies sweep
Calibration	Specifies measurement of calibration data
Compensation	Specifies measurement of fixture compensation data

**Examples** The following is an example of displaying a message when measurement of calibration data is completed. The following program has to be described in user form or class module.

**Example 18-10** Example of using SweepEnd event

```
Public WithEvents Evnt As E4991ALib.ApplicationPublic WithEvents  
Evnt As E4991ALib.Application  
  
Private Sub Evnt_SweepEnd(ByVal Mode As SweepMode)  
    If Mode = Measure Then  
        MsgBox "A measurement is completed."  
    ElseIf Mode = Calibration Then  
        MsgBox "A measurement of calibration data is completed."  
    ElseIf Mode = Compensation Then  
        MsgBox "A measurement of compensation data is completed."  
    End If  
End Sub
```

## SweepStart event

**Explanation** Indicates specified sweep (measurement) has started.

**Parameter** SweepMode: To be selected from the following.

Measure	Specifies sweep
Calibration	Specifies measurement of calibration data
Compensation	Specifies measurement of fixture compensation data

**Examples** The following is an example of loading and showing a user form (Abort\_yn) on the screen when the measurement of calibration data or fixture compensation data has started (the program code of Abort\_yn is not included in this sample). The following program has to be described in user form or class module.

**Example 18-11** **Example of using SweepStart event**

```
Public WithEvents Evnt As E4991ALib.Application

Private Sub Evnt_SweepStart(ByVal Mode As SweepMode)
    If Mode = Calibration Or Compensation Then
        Load Abort_yn
        Abort_yn.Show
    End If
End Sub
```

## CompleteSweepAveraging event

**Explanation** Indicates specified number of sweep averaging is completed when the sweep averaging function is used.

**Examples** The following is an example of producing a beep sound when the specified number of sweep averaging is completed. The following program has to be described in user form or class module.

**Example 18-12** **Example of using CompleteSweepAveraging event**

```
Public WithEvents Evnt As E4991ALib.Application

Private Sub Evnt_CompleteSweepAveraging()
    Application.SCPI.Output "SYST:BEEP"
End Sub
```

## Unlocked event

**Explanation**

Indicates that “PLL Unlock” error was detected in the E4991A.

**Examples**

The following is an example of stopping a program by force when a “PLL Unlock” error occurs during measurement. The following program has to be described in user form or class module.

**Example 18-13****Example of using Unlocked event**

```
Public WithEvents Evnt As E4991ALib.Application

Private Sub Evnt_Unlocked()
    MsgBox "Error: PLL Unlock"
End Sub
```

## DcBiasOverload event

**Explanation**

Indicates that “DC bias overload” error was detected in the E4991A.

**Examples**

The following is an example of stopping a program by force when a “DC bias overload” error occurs during measurement. The following program has to be described in user form or class module.

**Example 18-14****Example of using DcBiasOverload event**

```
Public WithEvents Evnt As E4991ALib.Application

Private Sub Evnt_DcBiasOverload()
    MsgBox "Error: Dc bias overload"
End Sub
```

### **RfOverload** event

**Explanation**

Indicates that “RF overload” error was detected in the E4991A.

**Examples**

The following is an example of stopping a program by force when the “RF overload” error occurs during measurement. The following program has to be described in user form or class module.

**Example 18-15**

**Example of using RfOverload event**

```
Public WithEvents Evnt As E4991ALib.Application

Private Sub Evnt_RfOverload()
    MsgBox "Error: RF overload"
End
End Sub
```



---

## SCPI object

This section explains details of the SCPI object.

### Name property

<b>Explanation</b>	Reads object name "SCPI" (Read only)
<b>VB syntax</b>	Application.SCPI.Name or SCPI.Name
<b>Response</b>	Reading in string type. Always "SCPI".
<b>Examples</b>	The following is a program example of reading the object name and displaying it in the message box.
<b>Example 18-16</b>	<b>Example of using Name property</b>

```
Dim Name As String
Name = Application.SCPI.Name
MsgBox "Object Name : " & Name
```

## Enter method

<b>Explanation</b>	Reads the returned value of an E4991A GPIB command executed by Query using the Output method.
<b>VB syntax</b>	Application.SCPI.Enter(Res,[fmt]) or SCPI.Enter(Res,[fmt])
<b>Parameter</b>	fmt: Specifies option parameters. The method of reading data can be specified by the following option parameters.  #                Receives data divided by comma (.). *                Skips data and clears one data item in the queue.  These option parameters can be used in combination, and also it is not necessary to specify one. For details on using option parameters, refer to “How to read array data” on page 544.
<b>Response</b>	Res: Sends back the response to Query command.  Data type should be specified as variant. When specifying a data type other than variant, refer to the description of Query response of applicable GPIB commands in Chapter 17, “GPIB Command Reference,” on page 275.
<b>Examples</b>	The following is a program example of using the <b>Enter method</b> .
<b>Example 18-17</b>	<b>Example of using Enter method</b>  <pre>Dim Trace_data As Variant Application.SingleMeasure Application.SCPI.Output "FORM:DATA ASC" Application.SCPI.Output "CALC1:DATA? FDATA" Application.SCPI.Enter Trace_data, "#"</pre>

## Output method

<b>Explanation</b>	Executes a GPIB command of the E4991A.
<b>VB syntax</b>	Application.SCPI.Output(Cmd) or SCPI.Output(Cmd)
<b>Parameter</b>	Cmd: Specifies GPIB command by enclosing it within double quotation marks (“”) in the form of a string.
<b>Examples</b>	The following is a program example of using the <b>Output method</b> .
<b>Example 18-18</b>	<b>Example of using Output method</b>

```
Application.SCPI.Output "DISP:TRAC1 ON"  
Application.SCPI.Output "DISP:TRAC1:TITL:DATA ""Test Data"" "  
Application.SCPI.Output "DISP:TRAC1:TITL ON"
```

## Query method

<b>Explanation</b>	Executes a GPIB command of the E4991A by Query and receives its response.
<b>VB syntax</b>	Application.SCPI.Query(Cmd) or SCPI.Query(Cmd)
<b>Parameter</b>	Cmd: Specifies GPIB command with “?” by enclosing it within double quotation marks (“”) in string form.
<b>Response</b>	Response to Query command is sent back.  Data type should be specified as variant. When specifying a data type other than variant, refer to the description of Query response of applicable GPIB commands in Chapter 17, “GPIB Command Reference,” on page 275.
<b>Examples</b>	The following is a program example of using the <b>Query method</b> .
<b>Example 18-19</b>	<b>Example of using Query method</b>

```
Dim Cw_freq As Double  
Cw_freq = Application.SCPI.Query("FREQ?")  
MsgBox "CW Frequency : " & Cw_freq & "Hz"
```

## How to read array data

In the case of using the **Output method** to send GPIB commands with "?", the returned values are built up in the queue provided in the E4991A main body. The **Enter method** is the object used to read data from that queue. If the data is a single data item that is not divided with commas (,), it can be read as is. In the case of data divided with commas (,), the required data can be read in the required form by specifying the following option parameters in the **Enter method**.

---

### NOTE

Binary formatted array data cannot be read by the **Enter method**. It is necessary to set the transfer format for reading array data to the ASCII format by using **FORM:DATA** on page 374 before using the **Enter method**.

## Option parameters offered in Enter method

The following option parameters can be specified in the **Enter method** as required.

- #                    Receives data by dividing data with comma (,).
- \*                    Skips a data item in the queue.

## Not specifying option parameter

When the **Enter method** is executed without specifying option parameters, the part of data to be read differs depending on the data type of the variable used in reading data. However, the contents of the queue become empty regardless of the data type.

- When the data type is numeric:

### Example 18-20    No specification of option parameters

Assume there are returned values ("1,2,3,4") of "SCPI.Output "DATA:RAW?" kept in the queue.

```
Dim Val as Double
SCPI.Output "DATA:RAW?"
SCPI.Enter Val
```

If "SCPI.Enter Val" is executed here, the first data only is read and substituted into Val (Val=1). The rest of the data is cancelled at this point, and the queue becomes empty.

- When the data type is string:

**Example 18-21 No specification of option parameters**

Assume there are returned values ("Agilent, E4991A, 113,1.0") from "SCPI.Output "\*IDN?" kept in the queue.

```
Dim Val as String
SCPI.Output "*IDN?"
SCPI.Enter Val
```

If "SCPI.Enter Val" is executed here, the entire data is read as one string and substituted into Val (Val = "Agilent, E4991A, 113,1.0"). At this point, the queue becomes empty.

- When the data type is variant:

**Example 18-22 No specification of option parameters**

Assume there are returned values ("1,2,3,4") of "SCPI.Output "DATA:RAW?" kept in the queue.

```
Dim Val as Variant
SCPI.Output "DATA:RAW?"
SCPI.Enter Val
```

If "SCPI.Enter Val" is executed here, the entire data is read as one string and substituted into Val (Val = "1,2,3,4"). At this point, the queue becomes empty.

## Specifying option parameters

When the **Enter method** is executed while specifying option parameters, it becomes possible to read the data divided with commas (,) in the required form.

### Aim: Reading the “n”th data

- When the data type is numeric:

#### Example 18-23 Specifying option parameters “\*” and “#”

Assume there are returned values ("1,2,3,4") of "SCPI.Output "DATA:RAW?" kept in the queue. The method to read the 3rd data item and empty the queue is as follows.

```
Dim Val as Double
SCPI.Output "DATA:RAW?"
SCPI.Enter Val, "#"
SCPI.Enter Val, "*", #"
SCPI.Enter Val
```

When "SCPI.Enter Val "#" is executed, the first data item only is read and substituted into Val (Val = 1). At this point, the 2nd data onward (2, 3, 4) still remain in the queue.

When "SCPI.Enter Val. "\*", #" is executed after that, the first data item in the queue is not read but skipped due to the specification of option parameter "\*". Therefore, Val = 1 still remains at this point. Also, the 3rd data onward (3, 4) still remain in the queue.

When "SCPI.Enter Val" is executed for the final time, the first data item in the queue is read and substituted into Val (Val = 3). The queue becomes empty because no option parameter "#" is specified at this point.

- When the data type is string:

**Example 18-24 Specifying option parameters "\*" and "#"**

Assume there are returned values ("Agilent, E4991A, 113,1.0") from "SCPI.Output "\*IDN?" kept in the queue. The method used to read the 2nd data item ("E4991A") divided with commas (,) and empty the queue is as follows.

```
Dim Val as String
SCPI.Output "*IDN?"
SCPI.Enter Val, "#"
SCPI.Enter Val, "#"
SCPI.Enter Val, ""
```

When "SCPI.Enter Val, #" is executed, the first data item only is read and substituted into Val (Val = "Agilent"). At this point, the 2nd data onward ("E4991A, 113,1.0") still remain in the queue.

Next, when "SCPI.Enter Val, #" is executed, the first data item only is read and substituted into Val (Val = "E4991A"). At this point, the 3rd data onward ("113,1.0") still remain in the queue.

Finally, when "SCPI.Enter Val, "" is executed, all of the data is cancelled and the queue becomes empty. At this point, Val = "E4991A" remains the same.

- When the data type is variant:

It is possible to read the data divided with commas (,) as a string array by specifying "#" as the option parameter and executing the command. Refer to Example 18-25 for details.

**Aim: Reading the entire data (array data) separated with commas.**

To read all of the comma (,) separated data (array data), specify the data type of the variable as variant.

**Example 18-25 Specifying option parameter "#"**

Assume there are returned values ("1,2,3,4") of "SCPI.Output "DATA:RAW?" kept in the queue.

```
Dim Val as Variant
SCPI.Output "DATA:RAW?"
SCPI.Enter Val, "#"
```

When "SCPI.Enter Val, #" is executed, all of the data is read in the form of a string array and substituted into Val (Val (0)=1, Val (1)=2, Val (2)=3 and Val (3)=4). At this point, the queue becomes empty.

**Aim: Skipping data and emptying the queue**

Basically, regardless of the specified data type of the variable, specifying only "\*" as the option parameter and executing the command with the **Enter method** cancels all of the data, and the queue becomes empty.

- When the data type is numeric:

**Example 18-26 Specifying option parameter "\*" only**

Assume there are returned values ("1,2,3,4") of "SCPI.Output "DATA:RAW?" kept in the queue.

```
Dim Dummy as Double
SCPI.Output "DATA:RAW?"
SCPI.Enter Dummy, "*"
```

When SCPI.Output Dummy "\*" is executed, all of the data is cancelled and the queue becomes empty.

- When the data type is string:

**Example 18-27 Specifying option parameter "\*" only**

Assume there are returned values ("Agilent, E4991A, 113,1.0") from "SCPI.Output "\*IDN?" kept in the queue.

```
Dim Dummy as String
SCPI.Output "*IDN?"
SCPI.Enter Dummy, "*"
```

When SCPI.Output Dummy "\*" is executed, all of the data is cancelled and the queue becomes empty.

- When the data type is variant:

**Example 18-28 Specifying option parameter "\*" only**

Assume there are returned values ("1,2,3,4") of "SCPI.Output "DATA:RAW?" kept in the queue.

```
Dim Dummy as Variant
SCPI.Output "DATA:RAW?"
SCPI.Enter Dummy, "*"
```

When "SCPI.Output Dummy "\*" is executed, all of the data is cancelled and the queue becomes empty.



---

## **A** **Manual Changes**

This appendix contains the information required to adapt this manual to versions or configurations of the Agilent E4991A manufactured earlier than the current printing date of this manual. The information contained elsewhere in this manual applies directly to E4991A units bearing the serial number printed on this manual's title page.

---

## Manual Changes

To adapt this manual to your E4991A, refer to Table A-1 and Table A-2.

**Table A-1** Manual Changes by Serial Number

Serial Prefix or Number	Make Manual Changes

**Table A-2** Manual Changes by Firmware Version

Version	Make Manual Changes

Agilent Technologies uses a two-part, ten-character serial number that is stamped on the serial number plate (Figure A-1). The first five characters are the serial prefix and the last five digits are the suffix.

**Figure A-1** Serial Number Plate



e4991aaj517

---

## **B** **GPIB Status Report System**

This appendix describes the status report system in the Agilent E4991A GPIB system.

## General Model of Status Registers

The E4991A has a status report system that notifies users of its states.

Figure B-1

General Model of Status Registers

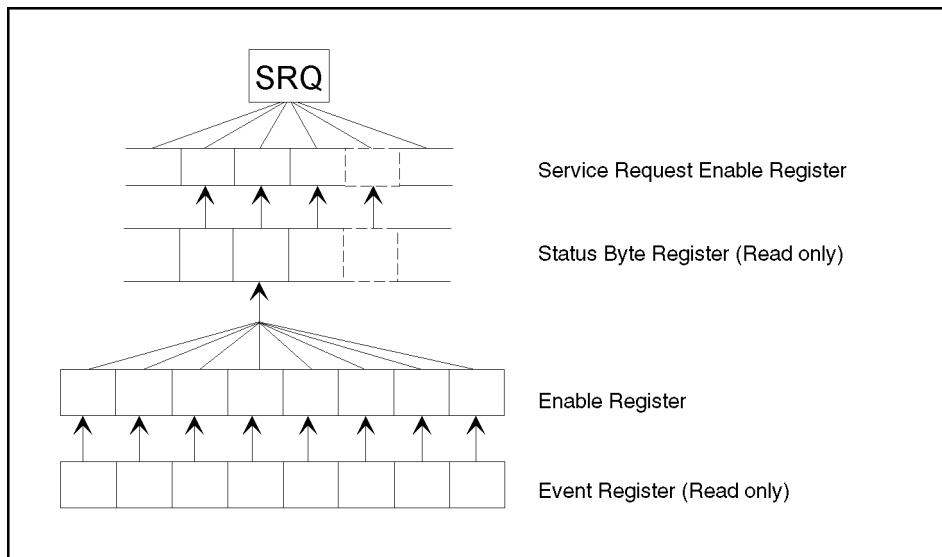

4294ape021

The status report system has a hierarchical structure as shown in Figure B-1. When the instrument meets a certain condition, the corresponding bit in the appropriate event register is set to 1. By monitoring event registers, users can grasp the state of the instrument.

If a bit in an event register is set to 1 and the corresponding bit (indicated by arrows in Figure B-1) in the enable register in the upper level is also set to 1, the summary bit of the Status Byte Register is set to 1. The state of the Status Byte Register can be obtained through serial poll.

If a bit in the Service Request Enable Register is set 1, a service request (SRQ) occurs when the corresponding bit in the Status Byte Register is set to 1. The SRQ informs the controller that the E4991A is requesting a service and a program to handle interrupt when the SRQ is generated. For how to use the SRQ, see “Using the Status Register” on page 112 or “Using Status Report Mechanism” on page 203.

## Event Registers

The bits in an event register reflect corresponding the E4991A states such as event occurrence. These bits are used to constantly monitor the E4991A state changes, and if a certain condition defined for each bit is met, the corresponding bit is changed to 1. Note that no GPIB command can change the status of event register bits.

The E4991A has the following types of event registers.

- Standard Event Status Register (For details, refer to Table B-2)
- Operation Status Event Register (For details, refer to Table B-3)
- Questionable Status Event Register (For details, refer to Table B-4)
- Questionable Status Hardware Event Register (For details, refer to Table B-5)
- Questionable Status Limit Event Register (For details, refer to Table B-6)
- Questionable Status Search Event Register (For details, refer to Table B-7)

## Enable Registers

By setting the bit(s) in an enable register, the user can select bit(s) of an event register that can set the summary bit in the Status Byte Register to 1 when an event has occurred. In other words, enable register bits can function as mask bits, enabling the event register bits corresponding to all of the enable register bits to be set to 1.

For example, you can specify that the summary bit in the Status Byte Register be set to 1 only when the bit in a certain event register is set to 1 by setting the corresponding enable register bit to 1.

## Status Byte Register

When an event register bit enabled by the corresponding enable register bit is set to 1, the corresponding summary bit in the Status Byte Register is also set to 1. In addition to the summary bit for the event register, the Status Event Register has a bit indicating the status of the output queue and a bit indicating SRQ status.

The Status Byte Register value can be read with the **\*STB?** command or serial poll (SPOLL statement in HTBasic) from the controller.

When the **\*STB?** command is used to read the Status Byte Register, the content of the register is not changed. On the other hand, when the SPOLL statement in HTBasic is used to read a Status Byte Register, the RQS bit in the Status Byte Register is cleared.

Table B-1 shows the content of the Status Byte Register in the E4991A. The serial poll reads bit 6 of the Status Byte Register as an RQS bit. On the other hand, the **\*STB?** command reads bit 6 as an MSS bit. For details on RQS and MSS bits, refer to Table B-1.

In addition, by setting the bit(s) in the Service Request Enable Register, service requests can be generated in conjunction with the Status Byte Register.

### Transition Filter and Condition Register

The E4991A status transition filter allows the user to select the transition direction of a bit's status in the status register, which sets the bit in the event register.

If the status register has transition filters, a lower level register called "condition register" exists under the event register. The transition filter lies between the event register and the condition register. The transition filter allows the corresponding event register bit to be set according to the positive transition, negative transition, or both of a bit in the condition register. For example, when a negative transition filter is set, if a negative transition has occurred in a bit of a condition register, that is, a bit in the condition register has changed from 1 to 0, the corresponding bit in the event register of the upper level is set to 1.

**Figure B-2**

**Status Transition Filter and Condition Register**

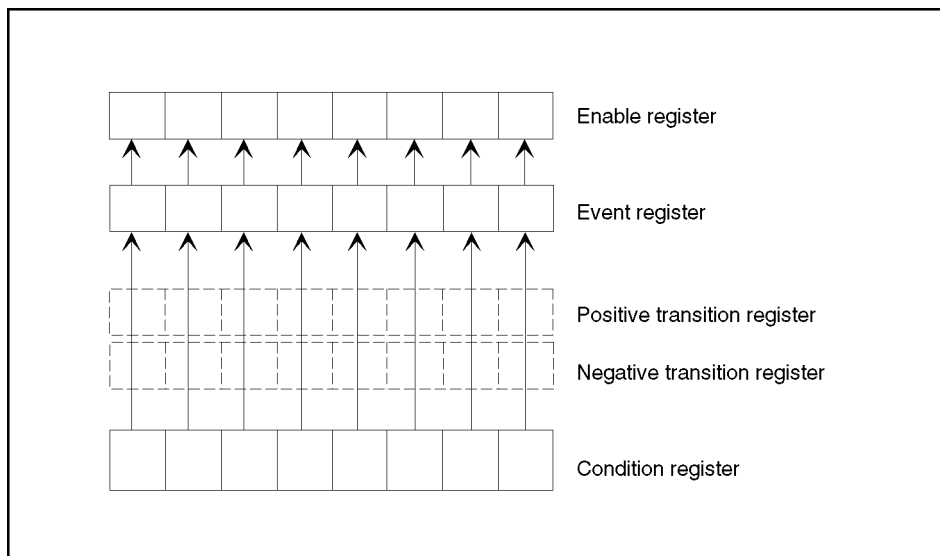

4294ape022

In the E4991A, the Operation Status Register and the Questionable Status Register have transition filters (Figure B-3). By monitoring status transition in bit 4 of the Operation Status Register, transition filters allow generation of an SRQ when the E4991A starts or stops measurement.

## **Status Register Structure**

Status registers have the structure shown in Figure B-3 and Figure B-4. The Status Byte Register has summary bits for the registers in the lower level. This section explains each layer in the E4991A's status register structure. For details on each bit in each status register, see Table B-1 to Table B-7.



Figure B-3 Status Register Structure (1/2)

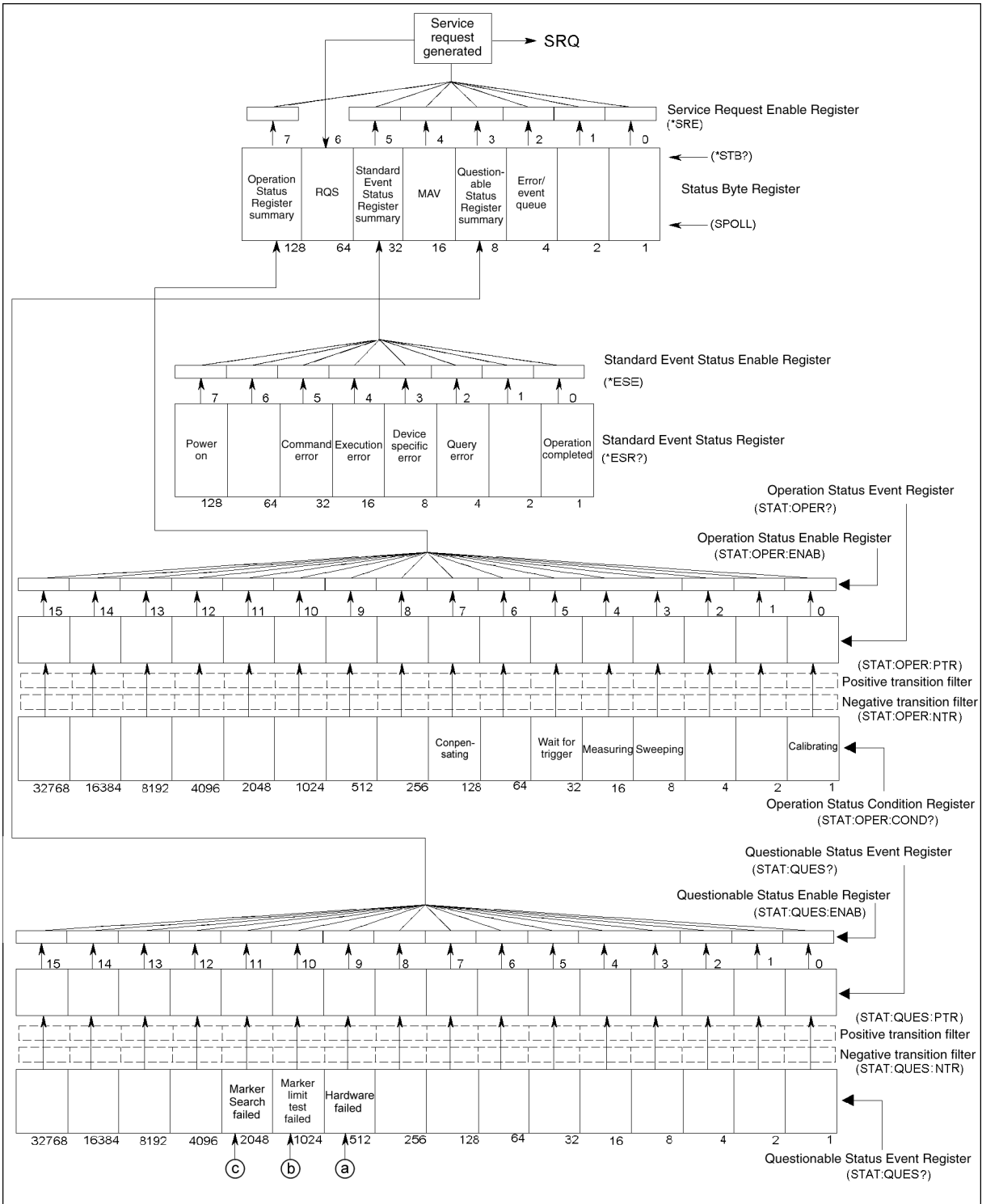

e4991ape032

GPIB Status Report System  
**Status Register Structure**

**Figure B-4** Status Register Structure (2/2)

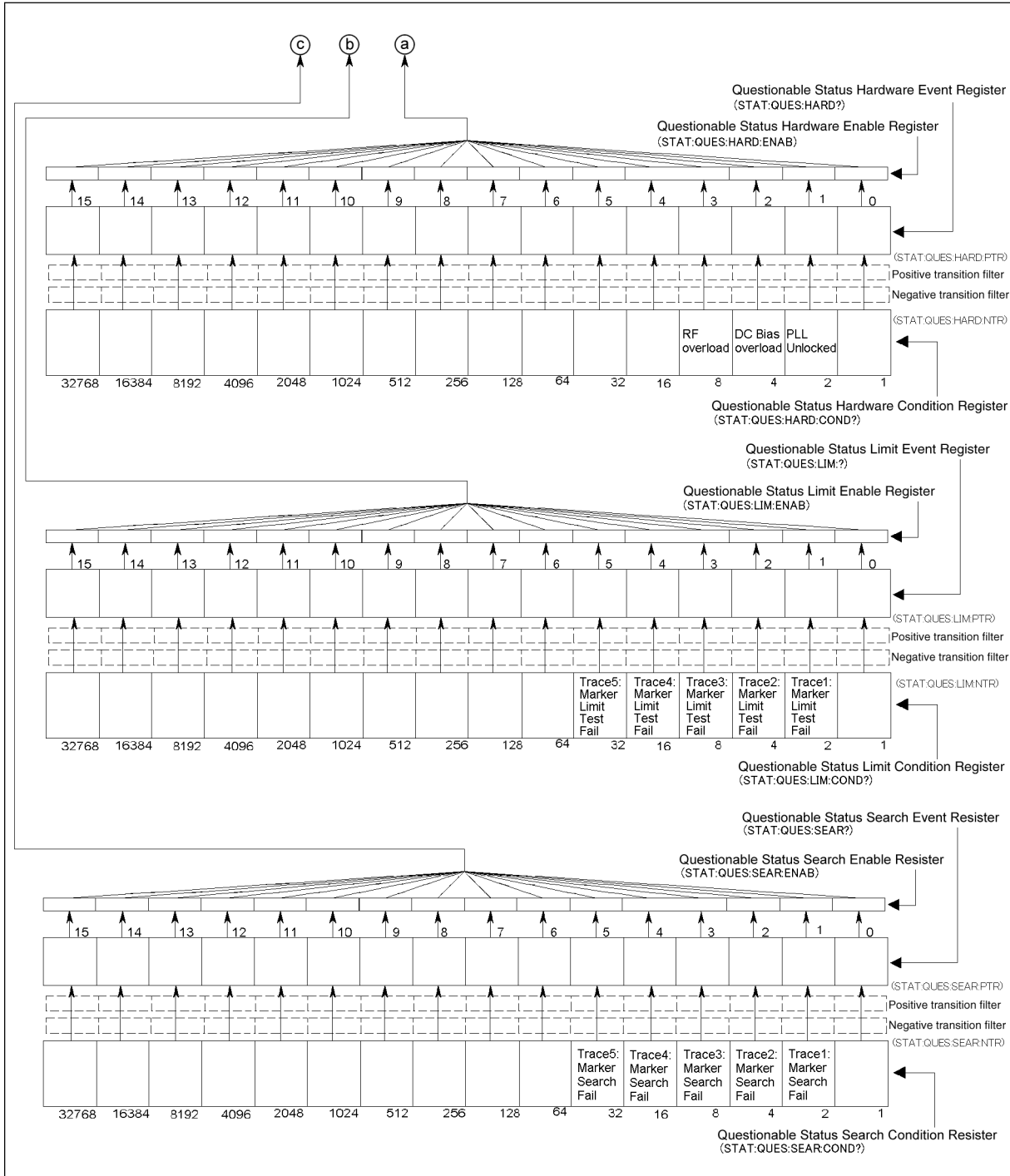

e4991ape028

**Table B-1 Status Bit Definition of Status Byte Register**

Bit position	Name	Description
0-1	Not used	Always 0.
2	Error/Event Queue	Set to 1 when the error/event queue contains data; reset to 0 when all of the data has been retrieved.
3	Questionable Status Register Summary Bit	Set to 1 when one of the enabled bits in the Questionable Status Register is set to 1.
4	MAV (Message Available)	Set to 1 when there is information waiting to be output and still not read. When the information is read, this bit is set to 0.
5	Standard Event Status Register Summary Bit	Set to 1 when one of the enabled bits in the Standard Event Status Register is set to 1.
6	RQS (Serial poll is used to read the Status Byte Register)	Set to 1 when E4991A generates SRQ. When the Status Byte Register is read by serial poll, this bit is set to 0.
	MSS (*STB? is used to read the Status Byte Register)	Set to 1 when one of the bits in the Status Byte Register enabled by the Service Request Enable Register is set to 1.
7	Operation Status Register Summary Bit	Set to 1 when one of the enabled bits in the Operation Status Register is set to 1.

When the **\*CLS** command is executed, each bit in the Status Byte Register is cleared.

GPIB Status Report System  
Status Register Structure

**Table B-2 Status Bit Definition of Standard Event Status Register**

Bit position	Name	Description
0	Operation Complete bit	Set to 1 upon completion of all operations done by commands that proceed the <b>*OPC?</b> command.
1	Not used	Always 0.
2	Query Error Bit	<ol style="list-style-type: none"> <li>1. Set to 1 when the E4991A has no transferred data in the output queue in spite of a Query request.</li> <li>2. Set to 1 when transferred data in the E4991A output queue have been lost because of an incoming new message.</li> </ol>
3	Device Dependent Error Bit	Set to 1 when an error other than command errors, Query errors, and execution errors has occurred.
4	Execution Error	<ol style="list-style-type: none"> <li>1. Set to 1 when a specified parameter in a GPIB command is out of range or cannot be processed by the E4991A.</li> <li>2. Set to 1 when a GPIB command cannot be executed correctly because of the E4991A's state.</li> </ol>
5	Command Error Bit	<ol style="list-style-type: none"> <li>1. Set to 1 when an IEEE 488.2 syntax error has occurred (a command sent to E4991A does not conform to the syntax stipulated by the IEEE 488.2 standard). Possible reasons are that a command parameter does not conform to the E4991A listen format or it is of a type E4991A cannot accept.</li> <li>2. Set to 1 when a semantic error has occurred. Possible reasons are that a command sent to the E4991A has a misspelling or is an IEEE 488.2 command that E4991A cannot process.</li> <li>3. Set to 1 when GET (Group Execution Trigger) is input to a program input buffer.</li> </ol>
6	Not used	Always 0
7	Power ON Bit	Set to 1 when the E4991A is powered on.

When the **\*CLS** command is executed, each bit in the Standard Event Status Register is cleared.

**Table B-3 Status Bit Definition of Operation Status Event Register**

Bit position	Name	Description
0	Calibrating	Set to 1 when the E4991A is measuring calibration data. When measurement is completed, this bit is set to 0.
1-2	Not used	Always 0.
3	Sweeping	Set to 1 when the E4991A is sweeping. When sweep is completed, this bit is set to 0.
4	Measuring	Set to 1 when the E4991A is measuring. When measurement is completed, this bit is set to 0. In the case of using the sweep averaging function, when sweep averaging is completed, this bit is set to 0 for the first time.
5	Waiting for Trigger	Set to 1 while waiting for trigger.
6	Not used	Always 0.
7	Compensating	Set to 1 when the E4991A is measuring fixture compensation data. When measurement is completed, this bit is set to 0.
8-15	Not used	Always 0.

When the **\*CLS** command is executed, each bit in the Operation Status Event Register is cleared.

**Table B-4 Status Bit Definition of Questionable Status Event Register**

Bit position	Name	Description
0-8	Not used	Always 0.
9	Measurement Failure	Set to 1 when a measurement failure has been detected in the E4991A.
10	Marker Limit Test Fail	Set to 1 when a marker limit test has failed.
11	Marker Search Fail	Set to 1 when a marker search has failed.
12-15	Not used	Always 0.

When the **\*CLS** command is executed, each bit in the Questionable Status Event Register is cleared.

**Table B-5 Status Bit Definition of Questionable Status Hardware Event Register**

Bit position	Name	Description
0	Not used	Always 0.
1	PLL Unlocked	Set to 1 when an unlocked phase lock loop has been detected in the E4991A.
2	DC Bias Overload	Set to 1 when dc bias current exceeding the maximum current limit is supplied or dc bias voltage exceeding the maximum voltage limit is detected.
3	RF Overload	Set to 1 when overload has been detected in the E4991A internal circuit.
4-15	Not used	Always 0.

When the **\*CLS** command is executed, each bit in the Questionable Status Hardware Event Register is cleared.

**Table B-6 Status Bit Definition of Questionable Status Limit Event Register**

Bit position	Name	Description
0	Not used	Always 0.
1	Trace 1: Marker Limit Test Fail	Set to 1 when the marker limit test has failed in trace 1.
2	Trace 2: Marker Limit Test Fail	Set to 1 when the marker limit test has failed in trace 2.
3	Trace 3: Marker Limit Test Fail	Set to 1 when the marker limit test has failed in trace 3.
4	Trace 4: Marker Limit Test Fail	Set to 1 when the marker limit test has failed in trace 4.
5	Trace 5: Marker Limit Test Fail	Set to 1 when the marker limit test has failed in trace 5.
6-15	Not used	Always 0

When the **\*CLS** command is executed, each bit in the Questionable Status Limit Event Register is cleared.

**Table B-7      Status Bit Definition of Questionable Status Search Event Register**

Bit position	Name	Description
0	Not used	Always 0.
1	Trace 1: Marker Search Fail	Set to 1 when the marker search has failed in trace 1.
2	Trace 2: Marker Search Fail	Set to 1 when the marker search has failed in trace 2.
3	Trace 3: Marker Search Fail	Set to 1 when the marker search has failed in trace 3.
4	Trace 4: Marker Search Fail	Set to 1 when the marker search has failed in trace 4.
5	Trace 5: Marker Search Fail	Set to 1 when the marker search has failed in trace 5.
6-15	Not used	Always 0

When the **\*CLS** command is executed, each bit in the Questionable Status Limit Event Register is cleared.

GPIB Status Report System  
**Status Register Structure**



---

## **C GPIB Command List By Function**

This appendix lists the Agilent E4991A GPIB commands according to function.

## GPIB Command List By Function

Function	Item to be set or executed		GPIB command		
Measurement Conditions	Preset	Turns off the continuous activation of the trigger system.	<b>*RST</b> on page 282		
		Turns on the continuous activation of the trigger system.	<b>SYST:PRES</b> on page 523		
	Selects measurement mode (Impedance/Dielectric/Magnetic measurement).		<b>MODE</b> on page 393		
	Material measurement (Option 002)	Material thickness for dielectric material measurement	<b>CALC:FORM:PAR:DIE</b> on page 300		
		DUT sizes for magnetic material measurement	<b>CALC:FORM:PAR:MAG</b> on page 302		
	Selects measurement parameters.		<b>CALC{1-5}:FORM</b> on page 298		
	Display format	Selects display format	<b>DISP:TRAC{1-5}:GRAT:FORM</b> on page 357		
		Selects Y-axis formats in scalar trace.	<b>DISP:TRAC{1-3}:Y:SPAC</b> on page 371		
	Phase measurement	Selects unit.	<b>CALC{1-5}:FORM:UNIT:ANGL</b> on page 303		
		Turns on/off expanded phase display.	<b>CALC{1-3}:FORM:PAR:EPH</b> on page 301		
	Sweep	Selects sweep parameter (sweep type).		<b>SWE:TYPE</b> on page 515	
		Number of Measurement points		<b>SWE:POIN</b> on page 511	
		Direction		<b>SWE:DIR</b> on page 508	
		Sweep time	Turns on/off the automatic setting.	<b>SWE:TIME:AUTO</b> on page 514	
			Sets sweep time	<b>SWE:TIME</b> on page 513	
		Delay time	For each sweep	<b>SWE:DWEL1</b> on page 508	
			For each measurement point	<b>SWE:DWEL2</b> on page 509	
		Frequency sweep range	Start/stop	Start value	<b>FREQ:STAR</b> on page 378
				Stop value	<b>FREQ:STOP</b> on page 379
			Center/span	Center value	<b>FREQ:CENT</b> on page 376
				Span value	<b>FREQ:SPAN</b> on page 377
		Full span		<b>FREQ:SPAN:FULL</b> on page 377	
		Oscillator current level sweep range	Mode (Sweep)		<b>SOUR:CURR:MODE</b> on page 460
			Start/stop	Start value	<b>SOUR:CURR:STAR</b> on page 468
				Stop value	<b>SOUR:CURR:STOP</b> on page 469
			Center/span	Center value	<b>SOUR:CURR:CENT</b> on page 458
		Span value		<b>SOUR:CURR:SPAN</b> on page 467	
		Oscillator voltage level sweep range	Mode (Sweep)		<b>SOUR:VOLT:MODE</b> on page 479
			Start/stop	Start value	<b>SOUR:VOLT:STAR</b> on page 487
				Stop value	<b>SOUR:VOLT:STOP</b> on page 488
			Center/span	Center value	<b>SOUR:VOLT:CENT</b> on page 477
		Span value		<b>SOUR:VOLT:SPAN</b> on page 486	
		Oscillator power level sweep range	Mode (Sweep)		<b>SOUR:POW:MODE</b> on page 472
Start/stop	Start value		<b>SOUR:POW:STAR</b> on page 474		
	Stop value		<b>SOUR:POW:STOP</b> on page 475		
Center/span	Center value		<b>SOUR:POW:CENT</b> on page 471		
	Span value	<b>SOUR:POW:SPAN</b> on page 473			

Function	Item to be set or executed		GPIB command		
Measurement conditions	Sweep	dc bias current sweep range (Option 001)	On/Off	<b>SOUR:CURR:OFFS:STAT</b> on page 465	
			Start/stop	Start value	<b>SOUR:CURR:OFFS:STAR</b> on page 464
				Stop value	<b>SOUR:CURR:OFFS:STOP</b> on page 466
			Center/span	Center value	<b>SOUR:CURR:OFFS:CENT</b> on page 462
				Span value	<b>SOUR:CURR:OFFS:SPAN</b> on page 463
		Maximum voltage limit	<b>SOUR:VOLT:LIM:OFFS</b> on page 478		
		dc bias voltage sweep range (Option 001)	On/Off	<b>SOUR:VOLT:OFFS:STAT</b> on page 484	
			Start/stop	Start value	<b>SOUR:VOLT:OFFS:STAR</b> on page 483
				Stop value	<b>SOUR:VOLT:OFFS:STOP</b> on page 485
			Center/span	Center value	<b>SOUR:VOLT:OFFS:CENT</b> on page 481
	Span value			<b>SOUR:VOLT:OFFS:SPAN</b> on page 482	
	Maximum current limit	<b>SOUR:CURR:LIM:OFFS</b> on page 459			
	Oscillator	CW frequency		<b>FREQ</b> on page 375	
		Current level	Mode (Fix)	<b>SOUR:CURR:MODE</b> on page 460	
			Output level	<b>SOUR:CURR</b> on page 457	
		Voltage level	Mode (Fix)	<b>SOUR:VOLT:MODE</b> on page 479	
			Output level	<b>SOUR:VOLT</b> on page 476	
		Power level	Mode (Fix)	<b>SOUR:POW:MODE</b> on page 472	
Output level			<b>SOUR:POW</b> on page 470		
dc bias (Option 001)		Fixed voltage source	On/Off	<b>SOUR:VOLT:OFFS:STAT</b> on page 484	
	Output level		<b>SOUR:VOLT:OFFS</b> on page 480		
	Maximum current limit		<b>SOUR:CURR:LIM:OFFS</b> on page 459		
	Fixed current source	On/Off	<b>SOUR:CURR:OFFS:STAT</b> on page 465		
		Output level	<b>SOUR:CURR:OFFS</b> on page 461		
		Maximum voltage limit	<b>SOUR:VOLT:LIM:OFFS</b> on page 478		
	Turns on/off the monitor function.		<b>CALC:BMON</b> on page 291		
	Averaging function	Point averaging	On/Off	<b>AVER</b> on page 287	
Factor			<b>AVER:COUN</b> on page 288		
Sweep averaging		On/Off	<b>CALC:AVER</b> on page 289		
		factor	<b>CALC:AVER:COUN</b> on page 290		
		Restart	<b>CALC:AVER:CLE</b> on page 289		

[GPIB Command List By Function](#)  
[GPIB Command List By Function](#)

Function	Item to be set or executed		GPIB command		
Measurement conditions	Only Segment sweep	Segment sweep table	Add segment.	<b>SEGM:COUN</b> on page 397	
			Delete all segments.	<b>SEGM:DEL:ALL</b> on page 406	
			Number of measurement points	Setting	<b>SEGM{1-16}:SWE:POIN</b> on page 413
				Read total number.	<b>SWE:POIN</b> on page 511
			Frequency sweep range	Start value	<b>SEGM{1-16}:FREQ:STAR</b> on page 409
				Stop value	<b>SEGM{1-16}:FREQ:STOP</b> on page 410
				Center value	<b>SEGM{1-16}:FREQ:CENT</b> on page 407
				Span value	<b>SEGM{1-16}:FREQ:SPAN</b> on page 408
			Oscillator current level	Mode On/Off	<b>SEGM:CURR:STAT</b> on page 402
				Output level	<b>SEGM{1-16}:CURR</b> on page 398
			Oscillator voltage level	Mode On/Off	<b>SEGM:VOLT:STAT</b> on page 418
				Output level	<b>SEGM{1-16}:VOLT</b> on page 414
			Oscillator power level	Mode On/Off	<b>SEGM:POW:STAT</b> on page 412
				Output level	<b>SEGM{1-16}:POW</b> on page 411
			dc bias (Fixed current source) (Option 001)	On/Off	<b>SOUR:CURR:OFFS:STAT</b> on page 465
				Mode On/Off	<b>SEGM:CURR:OFFS:STAT</b> on page 399
				Output level	<b>SEGM{1-16}:CURR:OFFS</b> on page 401
				Maximum voltage limit	<b>SEGM{1-16}:VOLT:LIM</b> on page 415
			dc bias (Fixed voltage source) (Option 001)	On/Off	<b>SOUR:VOLT:OFFS:STAT</b> on page 484
				Mode On/Off	<b>SEGM:VOLT:OFFS:STAT</b> on page 417
				Output level	<b>SEGM{1-16}:VOLT:OFFS</b> on page 416
				Maximum current limit	<b>SEGM{1-16}:CURR:LIM</b> on page 400
			Number of point averaging		<b>SEGM{1-16}:AVER:COUN</b> on page 396
			Sets parameter values collectively for a specified segment number.		<b>SEGM{1-16}:DATA</b> on page 403
			Sets parameter values collectively for all segments.		<b>SEGM:DATA:ALL</b> on page 405
			Delay time for each segment		<b>SWE:DWEL3</b> on page 510
			Sets frequency span display (Sort by frequency/For each segment).		<b>DISP:TRAC{1-5}:X:SPAC</b> on page 363
			Turns on/off the segment sweep table.		<b>DISP:TEXT{1-3}:SET</b> on page 356

Function	Item to be set or executed		GPIB command		
Display screen	Entire view	Enable/Disable display update.		<b>DISP:ENAB</b> on page 354	
		Text display screen	On/Off	<b>DISP:TEXT</b> on page 355	
			Selection	<b>DISP:TEXT{1-3}:SET</b> on page 356	
		Selects window format (Split window or Overlay).		<b>DISP:FORM</b> on page 355	
		Turns on/off the backlight.		<b>DISP:BACK</b> on page 354	
		Sets when display is refreshed	Refreshed for each sweep.		<b>SYST:IND:SWE:SET</b> on page 519
			Refreshed for each measurement point.		<b>SYST:IND:POIN:SET</b> on page 519
			Refreshed periodically.	On/Off Sets interval	<b>SYST:IND:TIME:SET</b> on page 521 <b>SYST:IND:TIME</b> on page 520
		Trace	On/Off		<b>DISP:TRAC{1-5}</b> on page 356
			Sets active trace.		<b>DISP:TRAC{1-5}:SEL</b> on page 358
	Selects display trace (Data/Memory/Both/Calculate results).		<b>CALC{1-5}:MATH:FUNC</b> on page 340		
	Copies measurement data to memory.		<b>CALC{1-5}:MATH:MEM</b> on page 341		
	Sets offset value by which data trace value is subtracted.		<b>CALC{1-3}:MATH:OFFS</b> on page 342		
	List on measurement screen.		On/Off	<b>DISP:TRAC{1-5}:TEXT</b> on page 359	
			Page scroll	<b>DISP:TRAC{1-5}:TEXT:PAGE</b> on page 359	
	Trace title.	On/Off	<b>DISP:TRAC{1-5}:TITL</b> on page 360		
		Entry	<b>DISP:TRAC{1-5}:TITL:DATA</b> on page 361		

[GPIB Command List By Function](#)  
[GPIB Command List By Function](#)

Function	Item to be set or executed			GPIB command	
Display screen	Scale	Selects trace to be displayed (Data/Memory/Couple).		<b>DISP:TRAC{1-5}:Y:FOR</b> on page 366	
		Automatic scale adjustment	For each trace		<b>DISP:TRAC{1-5}:Y:AUTO</b> on page 364
			For all traces		<b>DISP:TRAC:Y:AUTO:ALL</b> on page 364
		Linear Y-axis format (Scalar trace)	Max/Min	Maximum value	<b>DISP:TRAC{1-3}:Y:TOP</b> on page 372
				Minimum value	<b>DISP:TRAC{1-3}:Y:BOTT</b> on page 365
				Reference line's position	<b>DISP:TRAC{1-3}:Y:RPOS</b> on page 370
				Enable/Disable reference line.	<b>DISP:TRAC{1-3}:REF</b> on page 358
			Full scale /Reference value	Full scale value	<b>DISP:TRAC{1-5}:Y:FULL</b> on page 367
				Reference value	<b>DISP:TRAC{1-5}:Y:RLEV</b> on page 369
				Reference line's position	<b>DISP:TRAC{1-3}:Y:RPOS</b> on page 370
				Enable/Disable reference line.	<b>DISP:TRAC{1-3}:REF</b> on page 358
		Log Y-axis format (Scalar trace)	Maximum value		<b>DISP:TRAC{1-3}:Y:TOP</b> on page 372
			Minimum value		<b>DISP:TRAC{1-3}:Y:BOTT</b> on page 365
		Complex plane format (Complex trace)	X-axis reference value		<b>DISP:TRAC{4-5}:X:RLEV</b> on page 362
			Y-axis reference value		<b>DISP:TRAC{1-5}:Y:RLEV</b> on page 369
Full scale value			<b>DISP:TRAC{1-5}:Y:FULL</b> on page 367		
Polar format (Complex trace)	Full scale value		<b>DISP:TRAC{1-5}:Y:FULL</b> on page 367		

Function	Item to be set or executed		GPIB command	
Calibration	Calibration kit	Selects Load standard (7-mm/User-defined/Dielectric material measurement).	<b>SENS:CORR1:CKIT</b> on page 420	
		Defines standard value by user.	Turns on/off list setting function.	<b>SENS:CORR1:CKIT:LIST</b> on page 421
			Defines impedance value using list setting.	Open (G)
		Open (B)		<b>SENS:CORR1:CKIT:STAN1:LIST:B</b> on page 424
		Short (R)		<b>SENS:CORR1:CKIT:STAN2:LIST:R</b> on page 427
		Short (X)		<b>SENS:CORR1:CKIT:STAN2:LIST:X</b> on page 428
		Load (R)		<b>SENS:CORR1:CKIT:STAN3:LIST:R</b> on page 431
		Load (X)		<b>SENS:CORR1:CKIT:STAN3:LIST:X</b> on page 432
		Defines impedance value without using list setting.	Open (G)	<b>SENS:CORR1:CKIT:STAN1:G</b> on page 423
			Open (C)	<b>SENS:CORR1:CKIT:STAN1:C</b> on page 422
			Short (R)	<b>SENS:CORR1:CKIT:STAN2:R</b> on page 429
			Short (L)	<b>SENS:CORR1:CKIT:STAN2:L</b> on page 426
			Load (R)	<b>SENS:CORR1:CKIT:STAN3:R</b> on page 433
			Load (L)	<b>SENS:CORR1:CKIT:STAN3:L</b> on page 430
	Defines Load standard value for dielectric measurement (Option 002).	Relative permittivity	<b>SENS:CORR1:CKIT:STAN7:PRE</b> on page 435	
		Dielectric loss factor	<b>SENS:CORR1:CKIT:STAN7:PLF</b> on page 434	
		Thickness	<b>SENS:CORR1:CKIT:STAN7:THIC</b> on page 436	
	Calibration data/calibration coefficient	Data measurement points		<b>SENS:CORR1:COLL:FPO</b> on page 438
		Measures calibration data.		<b>SENS:CORR1:COLL</b> on page 437
		Clears calibration data array/calibration coefficient array.		<b>SENS:CORR1</b> on page 419
Calculates calibration coefficients and turns on calibration function.		<b>SENS:CORR1:COLL:SAVE</b> on page 439		
Electric length compensation	Test fixture	Selects test fixture (Agilent test fixture/Custom).	<b>SENS:CORR2:FIXT</b> on page 454	
		Reads electrical length of Agilent test fixture.	<b>SENS:CORR2:FIXT:EDEL:MODE:DIST?</b> on page 455	
		Sets/Reads electrical length of custom test fixture.	<b>SENS:CORR2:FIXT:EDEL:USER:DIST</b> on page 456	
	Other than test fixture	Sets offset time delay due to port extension.	<b>SENS:CORR2:EDEL:TIME</b> on page 453	

[GPIB Command List By Function](#)  
[GPIB Command List By Function](#)

Function	Item to be set or executed		GPIB command		
Fixture compensation	Fixture compensation kit	Defines standard value by user.	Turns on/off list setting function.	<b>SENS:CORR2:CKIT:LIST</b> on page 440	
			Sets impedance value using list setting.	Open (G)	<b>SENS:CORR2:CKIT:STAN1:LIST:G</b> on page 444
				Open (B)	<b>SENS:CORR2:CKIT:STAN1:LIST:B</b> on page 443
				Short (R)	<b>SENS:CORR2:CKIT:STAN2:LIST:R</b> on page 446
		Short (X)		<b>SENS:CORR2:CKIT:STAN2:LIST:X</b> on page 447	
		Sets impedance value without using list setting.	Open (G)	<b>SENS:CORR2:CKIT:STAN1:G</b> on page 442	
			Open (C)	<b>SENS:CORR2:CKIT:STAN1:C</b> on page 441	
			Short (R)	<b>SENS:CORR2:CKIT:STAN2:R</b> on page 448	
	Short (L)		<b>SENS:CORR2:CKIT:STAN2:L</b> on page 445		
	Fixture compensation data/fixture compensation coefficient	Data measurement points		<b>SENS:CORR2:COLL:FPO</b> on page 450	
		Measures fixture compensation data.		<b>SENS:CORR2:COLL:FPO</b> on page 450	
		Turns on/off fixture compensation function.	Open compensation	<b>SENS:CORR2:COLL:OPEN</b> on page 451	
			Short compensation	<b>SENS:CORR2:COLL:SHOR</b> on page 452	
Calculates fixture compensation coefficients and turns on fixture compensation function.		<b>SENS:CORR2:COLL:SAVE</b> on page 451			
Measurement	Trigger	Triggering	Available with Manual, External, or GPIB (BUS) trigger	<b>TRIG</b> on page 525	
			Available with GPIB (BUS) trigger	<b>*TRG</b> on page 284	
	Trigger system	Reset	Turns on/off continuous activation.	<b>INIT:CONT</b> on page 382	
			Initiate once	<b>INIT</b> on page 382	
			Trigger source.	<b>TRIG:SOUR</b> on page 526	
	Trigger event mode.		<b>TRIG:EVENT</b> on page 525		
	Polarity of external trigger.		<b>TRIG:SLOP</b> on page 526		



Function	Item to be set or executed		GPIB command	
Marker	Turns off all makers.		<b>CALC{1-5}:MARK:AOFF</b> on page 305	
	Turns on/off marker coupling function.		<b>CALC:MARK:COUP</b> on page 309	
	Movement mode (Continuous/Discrete)		<b>CALC{1-5}:MARK:DISC</b> on page 309	
	Objective trace selection (Data trace/Memory trace)		<b>CALC{1-5}:MARK:ON</b> on page 327	
	Marker 1-8	On/Off		<b>CALC{1-5}:MARK{1-8}</b> on page 304
		Sets to active marker.		<b>CALC{1-5}:MARK{1-8}:ACT</b> on page 305
		Sets/reads stimulus value.		<b>CALC{1-5}:MARK{1-8}:X</b> on page 338
		Reads measurement value.		<b>CALC{1-5}:MARK{1-8}:Y?</b> on page 339
	Reference marker	On/Off		<b>CALC{1-5}:MARK:REF</b> on page 328
		Sets to active marker.		<b>CALC{1-5}:MARK:REF:ACT</b> on page 329
		Sets/reads stimulus value.		<b>CALC{1-5}:MARK:REF:X</b> on page 334
		Sets/reads measurement value (Fixed $\Delta$ mode only).		<b>CALC{1-5}:MARK:REF:Y</b> on page 335
	$\Delta$ mode	Selects mode (Off/ $\Delta$ /Fixed $\Delta$ )		<b>CALC{1-5}:MARK:REF:TYPE</b> on page 333
	Sets sweep parameter by using stimulus/measurement value at active marker.			<b>CALC{1-5}:MARK:SET</b> on page 336
	Turns on/off marker list function,			<b>CALC{1-5}:MARK:LIST</b> on page 326
	Statistical analysis function	On/Off		<b>CALC{1-5}:MST</b> on page 343
		Reads analysis result.		<b>CALC{1-5}:MST:DATA?</b> on page 344
	Selects format when reading measurement value (Complex trace only).			<b>CALC{4-5}:MARK:FORM</b> on page 310
	Set unit of stimulus value at marker position.			<b>CALC{1-5}:MARK:UNIT</b> on page 337
	Limit test function	On/Off		<b>CALC{1-5}:MARK:FUNC:DOM:LIM:ALL</b> on page 314
		Marker 1-8	Turns on/off test marker.	<b>CALC{1-5}:MARK{1-8}:FUNC:DOM:LIM</b> on page 313
			Upper limit of limit test	<b>CALC{1-5}:MARK{1-8}:FUNC:DOM:LIM:UP</b> on page 318
			Lower limit of limit test	<b>CALC{1-5}:MARK{1-8}:FUNC:DOM:LIM:LOW</b> on page 316
Reference marker		Turns on/off test marker.	<b>CALC{1-5}:MARK:REF:FUNC:DOM:LIM</b> on page 329	
		Upper limit of limit test	<b>CALC{1-5}:MARK:REF:FUNC:DOM:LIM:UP</b> on page 332	
		Lower limit of limit test	<b>CALC{1-5}:MARK:REF:FUNC:DOM:LIM:LOW</b> on page 330	
Reads test results.		For all markers	<b>CALC{1-5}:MARK:FUNC:DOM:LIM:ALL:RES?</b> on page 315	
		For specified marker 1-8	<b>CALC{1-5}:MARK{1-8}:FUNC:DOM:LIM:RES?</b> on page 317	
		For reference marker	<b>CALC{1-5}:MARK:REF:FUNC:DOM:LIM:RES?</b> on page 331	
Displays test condition/test results for each marker.			<b>DISP:TEXT{1-3}:SET</b> on page 356	

[GPIB Command List By Function](#)  
[GPIB Command List By Function](#)

Function	Item to be set or executed		GPIB command	
Marker search function	Search definition/range	Partial search function	On/Off	<b>CALC{1-5}:MARK:FUNC:DOM</b> on page 312
			Sets active marker position to left boarder line.	<b>CALC{1-5}:MARK:FUNC:DOM:STAR</b> on page 320
			Sets active marker position to right boarder line.	<b>CALC{1-5}:MARK:FUNC:DOM:STOP</b> on page 320
			Range between reference marker and active marker.	<b>CALC{1-5}:MARK:FUNC:DOM:SPAN</b> on page 319
		Target value for target search		<b>CALC{1-5}:MARK:FUNC:TARG</b> on page 324
	Define peak value for peak search.	DX value		<b>CALC{1-5}:MARK:APE:EXC:X</b> on page 307
		DY value		<b>CALC{1-5}:MARK:APE:EXC:Y</b> on page 308
		Automatic definition using active marker		<b>CALC{1-5}:MARK:APE:SET</b> on page 306
	Turns on/off search tracking function.			<b>CALC{1-5}:MARK:FUNC:TRAC</b> on page 325
	Search	Selects what is searched for (Max/Min/Target/Positive peak/Negative peak).		<b>CALC{1-5}:MARK:FUNC</b> on page 311
		Execution (Max/Min/Target/Positive peak/Negative peak)		<b>CALC{1-5}:MARK:FUNC:EXEC</b> on page 321
Search for the next highest peak.		<b>CALC{1-5}:MARK:FUNC:EXEC:NEXT</b> on page 322		
Search for target or peak on the right.		<b>CALC{1-5}:MARK:FUNC:EXEC:RIGHT</b> on page 323		
Search for target or peak on the left.		<b>CALC{1-5}:MARK:FUNC:EXEC:LEFT</b> on page 322		
Equivalent circuit analysis	Selects equivalent circuit model.		<b>CALC{1-5}:EPAR:CIRC</b> on page 296	
	Performs analysis.		<b>CALC{1-5}:EPAR</b> on page 295	
	Reads/Sets equivalent circuit parameters (Analysis results).		<b>CALC{1-5}:DATA:EPAR</b> on page 294	
	Simulates frequency characteristics.		<b>CALC{1-5}:EPAR:SIM</b> on page 297	

Function	Item to be set or executed			GPIB command	
Read and write data	Data transfer	Selects format		<b>FORM:DATA</b> on page 374	
		Sets byte order during binary transfer.		<b>FORM:BORD</b> on page 373	
	Data array	Calibration	Reads calibration data array.		<b>DATA:CAD{1-8}?</b> on page 345
			Reads/Writes calibration coefficient array.		<b>DATA:CCO{1-6}</b> on page 346
		Fixture compensation	Reads fixture compensation data array.		<b>DATA:CMD{1-2}?</b> on page 347
			Reads/Writes fixture compensation coefficient array		<b>DATA:CMP{1-3}</b> on page 348
		Reads raw data array.			<b>DATA:RAW?</b> on page 349
	Data array for each segment (Segment sweep)	Calibration	Reads calibration data array.		<b>DATA:SEGM{1-16}:CAD{1-8}?</b> on page 350
			Reads/Writes calibration coefficient array.		<b>DATA:SEGM{1-16}:CCO{1-6}</b> on page 351
		Fixture compensation	Reads fixture compensation data array.		<b>DATA:SEGM{1-16}:CMD{1-2}?</b> on page 352
			Reads/Writes fixture compensation coefficient array.		<b>DATA:SEGM{1-16}:CMP{1-3}</b> on page 353
	Measurement results	Reads data trace array.			<b>CALC{1-5}:DATA?</b> on page 293
		Reads memory trace array.			<b>CALC{1-5}:DATA?</b> on page 293
		Reads dc bias level monitor array			<b>CALC:DATA:MON?</b> on page 292
		Reads stimulus array.			<b>SWE:STIM{1-4}?</b> on page 512
File-related	Reads list of files and folders.			<b>MMEM:CAT?</b> on page 383	
Save	State file			<b>MMEM:STOR</b> on page 388	
	Trace data file	File format	Binary format	<b>MMEM:STOR:TRAC</b> on page 391	
			ASCII format	<b>MMEM:STOR:TRAC:ASC</b> on page 391	
		Selects internal data array.		<b>MMEM:STOR:TRAC:SEL{1-4}</b> on page 392	
	Graphic data file	File format	JPEG format	<b>MMEM:STOR:GRAP</b> on page 389	
			Bitmap format	<b>MMEM:STOR:GRAP:BMP</b> on page 390	
	CITIfile			<b>MMEM:STOR:CITI{1-3}</b> on page 389	
	Macro			<b>MMEM:STOR:MACR</b> on page 390	
	Recall	State file			<b>MMEM:LOAD</b> on page 385
		Trace data file			<b>MMEM:LOAD:TRAC</b> on page 386
		Macro			<b>MMEM:LOAD:MACR</b> on page 385
Folder	Change current directory.			<b>MMEM:CDIR</b> on page 383	
	Create new			<b>MMEM:MDIR</b> on page 386	
	Delete			<b>MMEM:RDIR</b> on page 388	
Files	Rename			<b>MMEM:MOVE</b> on page 387	
	Copy			<b>MMEM:COPY</b> on page 384	
	Delete			<b>MMEM:DEL</b> on page 384	
Print	Graphic image	Selects print content.		<b>HCOP:CONT</b> on page 380	
		Selects print mode.		<b>HCOP:IMAG</b> on page 381	
	Output	Print		<b>HCOP</b> on page 380	
		Cancel		<b>HCOP:ABOR</b> on page 380	

**GPIB Command List By Function**  
**GPIB Command List By Function**

Function	Item to be set or executed	GPIB command	
Macro	Returns a list of macros	<b>PROG:CAT?</b> on page 394	
	Defines the macro name.	<b>PROG:NAME</b> on page 394	
	Sets the macro status.	<b>PROG:STAT</b> on page 395	
	Waits until the macro reaches the stop condition.	<b>PROG:WAIT</b> on page 395	
Status report system	Clears register.	<b>*CLS</b> on page 279	
	Reads Status Byte Register.	<b>*STB?</b> on page 283	
	Sets Service Request Enable Register.	<b>*SRE</b> on page 283	
	Standard Event Status Register	Reads register value.	<b>*ESR?</b> on page 280
		Sets enable register value.	<b>*ESE</b> on page 280
		Sets OPC bit on operation termination.	<b>*OPC</b> on page 281
	Operation Status Register	Reset	<b>STAT:PRES</b> on page 493
		Reads conditional register value.	<b>STAT:OPER:COND?</b> on page 489
		Sets enable register value.	<b>STAT:OPER:ENAB</b> on page 490
		Reads event register value.	<b>STAT:OPER?</b> on page 489
		Sets positive transition filter value.	<b>STAT:OPER:PTR</b> on page 492
		Sets negative transition filter value.	<b>STAT:OPER:NTR</b> on page 491
	Questionable Status Register	Reset	<b>STAT:PRES</b> on page 493
		Reads conditional register value.	<b>STAT:QUES:COND?</b> on page 493
		Sets enable register value.	<b>STAT:QUES:ENAB</b> on page 494
		Reads event register value.	<b>STAT:QUES?</b> on page 493
		Sets positive transition filter value.	<b>STAT:QUES:PTR</b> on page 504
	Questionable Status Hardware Register	Reset	<b>STAT:PRES</b> on page 493
		Reads conditional register value.	<b>STAT:QUES:HARD:COND?</b> on page 495
		Sets enable register value.	<b>STAT:QUES:HARD:ENAB</b> on page 496
		Reads event register value.	<b>STAT:QUES:HARD?</b> on page 495
		Sets positive transition filter value.	<b>STAT:QUES:HARD:PTR</b> on page 498
	Questionable Status Limit Register	Reset	<b>STAT:PRES</b> on page 493
		Reads conditional register value.	<b>STAT:QUES:LIM:COND?</b> on page 499
		Sets enable register value.	<b>STAT:QUES:LIM:ENAB</b> on page 500
		Reads event register value.	<b>STAT:QUES:LIM?</b> on page 499
		Sets positive transition filter value.	<b>STAT:QUES:LIM:PTR</b> on page 502
	Questionable Status Search Register	Reset	<b>STAT:PRES</b> on page 493
		Reads conditional register value.	<b>STAT:QUES:SEAR:COND?</b> on page 505
		Sets enable register value.	<b>STAT:QUES:SEAR:ENAB</b> on page 505
		Reads event register value.	<b>STAT:QUES:SEAR?</b> on page 504
		Sets positive transition filter value.	<b>STAT:QUES:SEAR:PTR</b> on page 507
	Beeper	Turns on/off the beep output	<b>SYST:BEEP:STAT</b> on page 516
Produces a beep sound		<b>SYST:BEEP</b> on page 516	
Internal clock	Date	<b>SYST:DATE</b> on page 517	
	Time	<b>SYST:TIME</b> on page 524	

Function	Item to be set or executed		GPIB command
Keyboard and Mouse	Enables/Disables keyboard operations.		<b>SYST:KLOC:KBD</b> on page 522
	Enables/Disables mouse operations.		<b>SYST:KLOC:MOUS</b> on page 523
	Enables/Disables front panel operations.		<b>SYST:KLOC</b> on page 522
	Powers off E4991A		<b>SYST:POFF</b> on page 523
Product information	Reads manufacturer, model number, serial number, and firmware version.		<b>*IDN?</b> on page 281
	Reads option number.		<b>*OPT?</b> on page 282
	Reads SCPI version.		<b>SYST:VERS?</b> on page 524
Error message	Reads number of errors.		<b>SYST:ERR:COUN?</b> on page 518
	Reads error queue.		<b>SYST:ERR?</b> on page 517
Others	Command	Waits for execution.	<b>*WAI</b> on page 284
		Returns 1 when completed.	<b>*OPC?</b> on page 281
		Sets OPC bit when operation completes.	<b>*OPC</b> on page 281
	Confirms whether external reference signal is inputted.		<b>SYST:EXTR?</b> on page 518
	Performs self-test and returns result.		<b>*TST?</b> on page 284

GPIB Command List By Function  
**GPIB Command List By Function**

---

## **D**      **Table of corresponding 4291B vs. E4991A GPIB commands**

This appendix lists each Agilent E4991A GPIB command along with its corresponding Agilent 4291B GPIB command. Note that the simple commands prepared for the 4291B do not have equivalent E4991A commands.

Table of corresponding 4291B vs. E4991A GPIB commands  
**Table of Corresponding GPIB Commands**

## Table of Corresponding GPIB Commands

ABORt:

4291B feature	4291B GPIB command	E4991A GPIB command
Reset the trigger system and place all trigger sequences in the idle state.	ABOR	<b>ABOR</b> on page 286

CALCulate subsystem:

4291B feature	4291B GPIB command	E4991A GPIB command
Sets the partial search of the marker search function ON or OFF.	CALC:EVAL:BAND:FULL	<b>CALC{1-5}:MARK:FUNC:DOM</b> on page 312
Sets the partial search range to the range between the marker and the $\Delta$ marker.	CALC:EVAL:BAND:SPAN DMAR	<b>CALC{1-5}:MARK:FUNC:DOM:SPAN</b> on page 319
Sets the left (lower) border of the partial search range at the current position of the marker.	CALC:EVAL:BAND:STAR MARK	<b>CALC{1-5}:MARK:FUNC:DOM:STAR</b> on page 320
Sets the right (higher) border of the partial search range at the current position of the marker.	CALC:EVAL:BAND:STOP MARK	<b>CALC{1-5}:MARK:FUNC:DOM:STOP</b> on page 320
Sets the coupled or uncoupled marker mode.	CALC:EVAL:COUP	<b>CALC:MARK:COUP</b> on page 309
Selects the destination channel of the marker->functions. When a marker->function is performed, the sweep parameter or amplitude value of the destination channel is changed.	CALC:EVAL:EFF:ON	None (No concept of channel)
Calculates and display the equivalent circuit parameters.	CALC:EVAL:EPAR	<b>CALC{1-5}:EPAR</b> on page 295
Selects the equivalent circuit.	CALC:EVAL:EPAR:CIRC	<b>CALC{1-5}:EPAR:CIRC</b> on page 296
Sets the continuous or discontinuous marker mode.	CALC:EVAL:INT	<b>CALC{1-5}:MARK:DISC</b> on page 309
Queries the marker statistics.	CALC:EVAL:MST:DATA?	<b>CALC{1-5}:MST:DATA?</b> on page 344
Calculates the marker statistics in the portion of the displayed trace that is in the search range.	CALC:EVAL:MST	<b>CALC{1-5}:MST</b> on page 343
Displays the marker and selects the trace on which the marker functions are used.	CALC:EVAL:ON1 "TR{1-21}"	None (Among each of the GPIB commands, specifies the trace number that enables the marker function.)
Displays the voltage or current level applied to the DUT at the marker point.	CALC:EVAL:ON2	<b>CALC:BMON</b> on page 291  (However, only the DC bias level can be monitored.)
Sets the peak $\Delta$ value that is used to define the peak.	CALC:EVAL:PEAK:EXC	<b>CALC{1-5}:MARK:APE:EXC:Y</b> on page 308
Sets the peak $\Delta$ value to the difference of amplitude values between the preset marker position and both side display points of the marker.		<b>CALC{1-5}:MARK:APE:SET</b> on page 306
Sets the peak $\Delta$ value that is used to define the peak.	CALC:EVAL:PEAK:EXC:X	<b>CALC{1-5}:MARK:APE:EXC:X</b> on page 307
Sets the peak $\Delta$ value to the difference of stimulus values between the preset marker position and both side display points of the marker.		<b>CALC{1-5}:MARK:APE:SET</b> on page 306
Sets the peak polarity for the marker search functions.	CALC:EVAL:PEAK:POL	Chooses positive peak/negative peak in the following command.  <b>CALC{1-5}:MARK:FUNC</b> on page 311
Sets the threshold values.	CALC:EVAL:PEAK:THR	None (Cannot set the threshold of the peak search function.)



Table of corresponding 4291B vs. E4991A GPIB commands  
**Table of Corresponding GPIB Commands**

4291B feature	4291B GPIB command	E4991A GPIB command
Sets the threshold ON or OFF.	CALC:EVAL:PEAK:THR:STAT	None (Cannot set the threshold of the peak search function.)
Selects a format to read out the value of a Smith, polar, or admittance chart using markers.	CALC:EVAL:R:FORM	<b>CALC{4-5}:MARK:FORM</b> on page 310
Returns the $\Delta$ marker value.	CALC:EVAL:REF:DATA?	Combines the following commands to execute.  <b>CALC{1-5}:MARK:REF:X</b> on page 334 <b>CALC{1-5}:MARK:REF:Y</b> on page 335
Sets the stimulus value of the $\Delta$ marker.	CALC:EVAL:REF:X	<b>CALC{1-5}:MARK:REF:X</b> on page 334
Sets the amplitude value of the fixed $\Delta$ marker.	CALC:EVAL:REF:Y	<b>CALC{1-5}:MARK:REF:Y</b> on page 335
Sets the auxiliary amplitude value of the fixed $\Delta$ marker. This command is used with a polar, Smith, or admittance chart.	CALC:EVAL:REF:Y2	<b>CALC{1-5}:MARK:REF:Y</b> on page 335
Queries the bandwidth parameters.	CALC:EVAL:WIDT:DATA?	None (No concept of bandwidth function.)
Sets the bandwidth function ON or OFF.	CALC:EVAL:WIDT:STAT	
Searches for another bandwidth cutoff point that is within the current cutoff point.	CALC:EVAL:WIDT:XPOS:IN	
Searches for another bandwidth cutoff point that is outside of the current cutoff point.	CALC:EVAL:WIDT:XPOS:OUT	
Selects the bandwidth cutoff point value as shown in the parameter table.	CALC:EVAL:WIDT:Y	
Queries the measurement values and stimulus values at the marker position.(Query only)	CALC:EVAL:Y{1-8}:DATA?	Combines the following commands to execute.  <b>CALC{1-5}:MARK{1-8}:X</b> on page 338 <b>CALC{1-5}:MARK{1-8}:Y?</b> on page 339
Queries the amplitude value at the marker position. (Query only)	CALC:EVAL:Y{1-8}:VAL{1 2}?	<b>CALC{1-5}:MARK{1-8}:Y?</b> on page 339
Sets a marker or sub-markers at the point of the stimulus when the marker is ON.	CALC:EVAL:Y{1-8}:XPOS	<b>CALC{1-5}:MARK{1-8}:X</b> on page 338
Moves the marker to the peak to the left of the present marker position.	CALC:EVAL:Y:XPOS:LPE	Combines the following commands to execute.
Moves the marker to the next occurrence of the target value to the left of the present marker position.	CALC:EVAL:Y:XPOS:LTAR	<b>CALC{1-5}:MARK:FUNC</b> on page 311 <b>CALC{1-5}:MARK:FUNC:EXEC:LEFT</b> on page 322
Moves the marker to the maximum point.	CALC:EVAL:Y:XPOS:MAX	<b>CALC{1-5}:MARK:FUNC:EXEC</b> on page 321
Moves the marker to the minimum point.	CALC:EVAL:Y:XPOS:MIN	
Moves the marker to the next peak.	CALC:EVAL:Y:XPOS:NPE	<b>CALC{1-5}:MARK:FUNC:EXEC:NEXT</b> on page 322
Moves the marker to the peak point.	CALC:EVAL:Y:XPOS:PEAK	<b>CALC{1-5}:MARK:FUNC:EXEC</b> on page 321
Moves the marker to the specified data point number.	CALC:EVAL:Y{1-8}:XPOS:POIN	None (Cannot move a marker by specifying a measurement point.)

D. Table of corresponding 4291B vs. E4991A GPIB commands

Table of corresponding 4291B vs. E4991A GPIB commands  
**Table of Corresponding GPIB Commands**

4291B feature	4291B GPIB command	E4991A GPIB command
Moves the marker to the peak to the right of the present marker position.	CALC:EVAL:Y:XPOS:RPE	Combines the following commands to execute.
Moves the marker to the next occurrence of the target value to the right of the present marker position.	CALC:EVAL:Y:XPOS:RTAR	<b>CALC{1-5}:MARK:FUNC</b> on page 311 <b>CALC{1-5}:MARK:FUNC:EXEC:RIGHT</b> on page 323
Sets the target value. The target search function moves the marker to a specific target point on the trace.	CALC:EVAL:Y:XPOS:TARG	<b>CALC{1-5}:MARK:FUNC:EXEC</b> on page 321
Sets the search tracking function.	CALC:EVAL:Y:XPOS:TRACK	<b>CALC{1-5}:MARK:FUNC:TRAC</b> on page 325
Sets the measurement parameter.	CALC:FORM	<b>CALC{1-5}:FORM</b> on page 298
Selects the unit of phase format.	CALC:FORM:UNIT:ANGL	<b>CALC{1-5}:FORM:UNIT:ANGL</b> on page 303
Turns the limit test beeper ON or OFF.	CALC:LIM:BEEP	None (Use the <b>SYST:BEEP</b> on page 516 command as necessary.)
Sets the limit test beeper.	CALC:LIM:COND	
Clears all segments in the limit line.	CALC:LIM:CLE	None
Adds or subtracts an offset from the stimulus values of the limit line.	CALC:LIM:CONT]:OFFS	None (Cannot add an offset to the limit.)
Displays limit lines.	CALC:LIM:LINE	None (Always indicated.)
Adds or subtracts an offset from the amplitude value of the limit line.	CALC:LIM:OFFS	None (Cannot add an offset to the limit.)
Completes editing the limit table.	CALC:LIM:SAVE	None (No need to declare.)
Specifies which limit segment in the table to edit.	CALC:LIM:SEGM	None (Specifies a marker number in the GPIB command used for creating a limit table.)
Adds a new segment to the end of the limit table.	CALC:LIM:SEGM:ADD	Sets a specified marker for a test marker using the following commands.) <b>CALC{1-5}:MARK{1-8}:FUNC:DOM:LIM</b> on page 313 <b>CALC{1-5}:MARK:REF:FUNC:DOM:LIM</b> on page 329
Sets the stimulus value of a segment.	CALC:LIM:SEGM:CONT	Moves the markers to a stimulus value specified by the following commands. <b>CALC{1-5}:MARK{1-8}:X</b> on page 338 <b>CALC{1-5}:MARK:REF:X</b> on page 334
Deletes a limit testing segment.	CALC:LIM:SEGM:DEL	Sets off the test marker using the following commands.) <b>CALC{1-5}:MARK{1-8}:FUNC:DOM:LIM</b> on page 313 <b>CALC{1-5}:MARK:REF:FUNC:DOM:LIM</b> on page 329
Sets the limits an equal amount above and below a specified middle value instead of setting upper and lower limits separately.	CALC:LIM:SEGM:DELTA	None (Cannot set the limit with the central value and delta value.)
Starts editing the segment.	CALC:LIM:SEGM:EDIT	None (No need to declare.)

Table of corresponding 4291B vs. E4991A GPIB commands  
**Table of Corresponding GPIB Commands**

4291B feature	4291B GPIB command	E4991A GPIB command
Sets the lower limit value for the segment.	CALC:LIM:SEGM:LOW	Sets using the following commands. <b>CALC{1-5}:MARK{1-8}:FUNC:DOM:LIM:LOW</b> on page 316 <b>CALC{1-5}:MARK:REF:FUNC:DOM:LIM:LOW</b> on page 330
Sets the midpoint for delta limits.	CALC:LIM:SEGM:MIDD	None (Cannot set the limit with the central value and delta value.)
Terminates a limit segment definition.	CALC:LIM:SEGM:SAVE	None (No need to declare.)
Sets the upper limit value for a limit testing segment.	CALC:LIM:SEGM:UPP	Sets value with these commands: <b>CALC{1-5}:MARK{1-8}:FUNC:DOM:LIM:UP</b> on page 318 <b>CALC{1-5}:MARK:REF:FUNC:DOM:LIM:UP</b> on page 332
Sets the limit testing ON or OFF.	CALC:LIM:STAT	<b>CALC{1-5}:MARK:FUNC:DOM:LIM:ALL</b> on page 314
Returns the available parameters that can be used with the CALC:MATH1:NAME command.	CALC:MATH1:CAT?	None
Sets the thickness of the dielectric material under test.	CALC:MATH1:DIM1	<b>CALC:FORM:PAR:DIE</b> on page 300
Sets the size of the toroidal core under test.	CALC:MATH1:DIM2	<b>CALC:FORM:PAR:MAG</b> on page 302
Sets the measurement parameter of the active channel, converting impedance to an admittance, permittivity, permeability or reflection coefficient.	CALC:MATH1:NAME	None
Sets the measurement parameter of the active channel, converting impedance to an admittance or reflection coefficient.	CALC:MATH1:STAT	(Can select a measurement parameter directly using <b>CALC{1-5}:FORM</b> on page 298.)
Returns the available parameters that can be used with the CALC:MATH2:NAME command.	CALC:MATH2:CAT?	None
Sets the data math operation.	CALC:MATH2:NAME	<b>CALC{1-5}:MATH:FUNC</b> on page 340
Sets data math function ON or OFF.	CALC:MATH2:STAT	(Simultaneously performs the setting of the calculation function and the on/off switching. However, the data calculation function type differs from that of the 4291B.)

D. Table of corresponding 4291B vs. E4991A GPIB commands

DATA subsystem:

4291B feature	4291B GPIB command	E4991A GPIB command
Defines the following values: the auxiliary part of the offset value, the gain value of the data math function, the zooming aperture value as a percentage of the span.	DATA	None (No function to set the value.)
Defines the offset values.	DATA OFFS	<b>CALC{1-3}:MATH:OFFS</b> on page 342
Sets the marker's amplitude value into the offset value.		<b>CALC{1-5}:MARK:SET</b> on page 336
Sends the calibration coefficient arrays.	DATA CCO{11-33}	<b>DATA:CCO{1-6}</b> on page 346
Returns the calibration coefficient arrays.	DATA? CCO{11-33}	In addition, it is possible to send/read the array for each segment if the following command is used. <b>DATA:SEGM{1-16}:CCO{1-6}</b> on page 351

Table of corresponding 4291B vs. E4991A GPIB commands  
**Table of Corresponding GPIB Commands**

4291B feature	4291B GPIB command	E4991A GPIB command
Sends the compensation coefficient arrays.	DATA CMP{1-3}	<b>DATA:CMW{1-3}</b> on page 348
Returns the compensation coefficient arrays.	DATA? CMP{1-3}	In addition, it is possible to send/read the array for each segment if the following command is used.  <b>DATA:SEGM{1-16}:CMP{1-3}</b> on page 353
Sends the data array.	DATA DATA	None (Cannot send/read a data array.)
Returns the data array.	DATA? DATA	
Sends the raw data array.	DATA RAW	None (Cannot send a raw data array.)
Returns the raw data array.	DATA? RAW	<b>DATA:RAW?</b> on page 349
Sends the fixture compensation open standard array.	DATA OADM	Combining and executing the following commands makes it possible to send/read the open standard array (G-B).  <b>SENS:CORR2:CKIT:STAN1:LIST:B</b> on page 443  <b>SENS:CORR2:CKIT:STAN1:LIST:G</b> on page 444
Returns the fixture compensation open standard array.	DATA? OADM	
Sends the fixture compensation short standard array.	DATA SIMP	Combining and executing the following commands makes it possible to send/read out the short standard array (R-X).  <b>SENS:CORR2:CKIT:STAN2:LIST:R</b> on page 446  <b>SENS:CORR2:CKIT:STAN2:LIST:X</b> on page 447
Returns the fixture compensation short standard array.	DATA? SIMP	
Sends the fixture compensation load standard array.	DATA LIMP	None (No concept of load compensation function.)
Returns the fixture compensation load standard array.	DATA? LIMP	
Sends the level monitor array.	DATA MON	None (cannot send)
Returns the level monitor array.	DATA? MON	<b>CALC:DATA:MON?</b> on page 292  (Only the DC bias monitor function is possible.)
Defines the specified equivalent circuit parameter.	DATA {EQC0 EQC1 EQL1 EQR1}	<b>CALC{1-5}:DATA:EPAR</b> on page 294

Table of corresponding 4291B vs. E4991A GPIB commands  
**Table of Corresponding GPIB Commands**

4291B feature	4291B GPIB command	E4991A GPIB command
Returns the limit test result of the fail points.	DATA? LFA	Combines the following commands in execution. <b>CALC{1-5}:MARK:REF:FUNC:DOM:LIM:RES?</b> on page 331 <b>CALC{1-5}:MARK:REF:X</b> on page 334 <b>CALC{1-5}:MARK:REF:FUNC:DOM:LIM:UP</b> on page 332 <b>CALC{1-5}:MARK:REF:FUNC:DOM:LIM:LOW</b> on page 330 <b>CALC{1-5}:MARK{1-8}:FUNC:DOM:LIM:RES?</b> on page 317 <b>CALC{1-5}:MARK{1-8}:X</b> on page 338 <b>CALC{1-5}:MARK{1-8}:FUNC:DOM:LIM:UP</b> on page 318 <b>CALC{1-5}:MARK{1-8}:FUNC:DOM:LIM:LOW</b> on page 316
Returns the limit test result of all measurement points.	DATA? LLIS	<b>CALC{1-5}:MARK:FUNC:DOM:LIM:ALL:RES?</b> on page 315  (However, only returns the overall decision result of all test markers and cannot even read the test conditions.)
Returns the limit test result at the marker.	DATA? LMAR	Uses the following commands to read the marker position test result. However, the test conditions cannot be read. <b>CALC{1-5}:MARK{1-8}:FUNC:DOM:LIM:RES?</b> on page 317 <b>CALC{1-5}:MARK:REF:FUNC:DOM:LIM:RES?</b> on page 331
Returns the selected memory array.	DATA? MEM	None
Returns the stimulus array (scalar).	DATA? SPAR	<b>SWE:STIM{1-4}?</b> on page 512
Returns the value at a specified point.	DATA:VAL?	None (Cannot specify a measurement point to read data.)
Sets the fixture compensation standard arrays.	DATA:DEF	Combines the following commands in execution. However, there is no load standard array. In addition, open standard is defined as G-B and short standard as R-X. <b>SENS:CORR2:CKIT:STAN1:LIST:B</b> on page 443 <b>SENS:CORR2:CKIT:STAN1:LIST:G</b> on page 444 <b>SENS:CORR2:CKIT:STAN2:LIST:R</b> on page 446 <b>SENS:CORR2:CKIT:STAN2:LIST:X</b> on page 447
Clears the fixture compensation standard array.	DATA:DEL	None

D. Table of corresponding 4291B vs. E4991A GPIB commands

Table of corresponding 4291B vs. E4991A GPIB commands  
**Table of Corresponding GPIB Commands**

4291B feature	4291B GPIB command	E4991A GPIB command
Returns the number of the limit test fail points.	DATA:POIN? LFA	None  However, it is possible to specify a marker to read pass/fail by using the following commands.  <b>CALC{1-5}:MARK{1-8}:FUNC:DO M:LIM:RES?</b> on page 317  <b>CALC{1-5}:MARK:REF:FUNC:DO M:LIM:RES?</b> on page 331

DIAGnostics subsystem:

4291B feature	4291B GPIB command	E4991A GPIB command
Queries whether the external reference signal is connected to the external reference input on the rear panel.	DIAG:EREF:STAT?	<b>SYST:EXTR?</b> on page 518
Returns the model number and the firmware version.	DIAG:FREV?	<b>*IDN?</b> on page 281
Returns the power-on test result.	DIAG:INIT:RES?	None

DISPlay subsystem:

4291B feature	4291B GPIB command	E4991A GPIB command
Blanks the frequency notation for security purposes.	DISP:ANN:FREQ	None
Sets backlighting of the LCD ON or OFF.	DISP:BACK	<b>DISP:BACK</b> on page 354
Sets the display intensity as a percent of the brightest setting.	DISP:BRIG	None
Resets the color being modified to the default color.	DISP:CMP:COL:DEF	
Changes color of the display element.	DISP:CMP:CLO{1-14}:HSL	
Sets all the color settings back to the default values.	DISP:CMP:DEF	
Recalls the previously saved color settings from the non-volatile memory.	DISP:CMP:LOAD	
Saves the current color setting to the non-volatile memory.	DISP:CMP:STOR	
Sets the background intensity of the display as a percent of the white level.	DISP:CONT	
Selects the display allocation mode.	DISP:ALL	None (Split display of the measurement display and macro display is not possible.)
Sets the full-screen or split display when in the dual channel mode.	DISP:FORM	None (No concept of channel.)  However, when a scalar trace is displayed, it is possible to switch between split windows and overlay windows using the following command.  <b>DISP:FORM</b> on page 355
Sets the I-BASIC graphic function ON or OFF.	DISP:GRAP:STAT	None (I-BASIC not loaded)
Erases all labels.	DISP:TEXT{11-30}:CLE	None (Cannot delete all trace titles at once.)
Selects the color of the specified label.	DISP:TEXT{11-30}:COL	None

Table of corresponding 4291B vs. E4991A GPIB commands  
**Table of Corresponding GPIB Commands**

4291B feature	4291B GPIB command	E4991A GPIB command
Sets the string to the following display area.	DISP:TEXT{10-38}	Combines the following commands in execution. <b>DISP:TRAC{1-5}:TITL:DATA</b> on page 361 <b>DISP:TRAC{1-5}:TITL</b> on page 360
Defines where the specified label appears.	DISP:TEXT{11-30}:LOC	None (Display area of trace title is fixed.)
Selects a page of a tabular list.	DISP:TEXT{1-8}:PAGE	<b>DISP:TEXT{1-3}:SET</b> on page 356
Displays a tabular list.	DISP:TEXT{1-9 39 40}:STAT	Displays each list using the following commands. <b>CALC{1-5}:MARK:LIST</b> on page 326 <b>DISP:TEXT{1-3}:SET</b> on page 356
Clears memory traces or user traces.	DISP:TRAC{2-21}:CLE	None (Cannot delete the traces at once.)
Sets the four user traces axis to coupled or uncoupled.	DISP:TRAC{18-21}:GRAT:AXIS:COU P	None (No concept of user trace.)
Selects the display format.	DISP:TRAC1:GRAT:FORM	<b>DISP:TRAC{1-5}:GRAT:FORM</b> on page 357
Sets the grid on the display of the selected channel ON or OFF.	DISP:TRAC{1-21}:GRAT:GRID	None (Cannot switch the on/off of the grid display.)
Turns off all markers and cancels all settings of the marker functions.	DISP:TRAC{1-21}:MARK:ALL:DEF	<b>CALC{1-5}:MARK:AOFF</b> on page 305
Turns the marker ON or OFF.	DISP:TRAC{1-21}:MARK:ALL:STAT	Uses the following commands to turn on/off the marker. <b>CALC{1-5}:MARK{1-8}</b> on page 304 <b>CALC{1-5}:MARK:REF</b> on page 328
Displays the $\Delta$ marker at the point of the marker and the marker mode changes to the $\Delta$ mode.	DISP:TRAC{1-21}:MARK:REL	Combines the following commands to execute.
Changes the marker mode to the fixed or tracking $\Delta$ mode.	DISP:TRAC{1-21}:MARK:REL:REF	<b>CALC{1-5}:MARK:REF</b> on page 328 <b>CALC{1-5}:MARK:REF:TYPE</b> on page 333
Displays specified sub-marker at the point of the marker (ON).	DISP:TRAC{1-21}:MARK{2-8}:STAT	None (No concept of sub-marker.)
Selects the marker X-axis unit.	DISP:TRAC{1-21}:MARK{1-8}:UNIT	<b>CALC{1-5}:MARK:UNIT</b> on page 337
Selects the trace to be displayed.	DISP:TRAC{1-21}:STAT	<b>CALC{1-5}:MATH:FUNC</b> on page 340
Defines the left edge value of the X-axis of the graticule for the user trace.	DISP:TRAC{1-21}:X:LEFT	None (No concept of user trace.)
Defines the right edge value of the X-axis of the graticule for the user trace.	DISP:TRAC{1-21}:X:RIGH	
Sets the value of the X-axis reference when the measurement format is set to the complex plane.	DISP:TRAC{1-21}:X:RLEV	<b>DISP:TRAC{4-5}:X:RLEV</b> on page 362
Selects the sweep type of Data&Memory trace, LINear or LOGarithmic. Selects the scale of the user trace, LINear or LOGarithmic. Selects the order base on frequency base list sweep.	DISP:TRAC{1-21}:X:SPAC	<b>DISP:TRAC{1-5}:X:SPAC</b> on page 363
Defines the X-axis unit of the graticule for the user trace.	DISP:TRAC{1-21}:X:UNIT	None (No concept of user trace.)
Adjusts the display scale and brings the trace data, defined by the TRACe{1-21} node, into view on the display.	DISP:TRAC{1-21}:Y:AUTO ONCE	<b>DISP:TRAC{1-5}:Y:AUTO</b> on page 364

D. Table of corresponding 4291B vs. E4991A GPIB commands

Table of corresponding 4291B vs. E4991A GPIB commands  
**Table of Corresponding GPIB Commands**

4291B feature	4291B GPIB command	E4991A GPIB command
Defines the bottom border of the display and adjusts the scale value.	DISP:TRAC{1-21}:Y:BOTT	<b>DISP:TRAC{1-3}:Y:BOTT</b> on page 365
Couples or uncouples the DATA and MEMORY traces to be scaled.	DISP:TRAC{1-21}:Y:COUP	<b>DISP:TRAC{1-5}:Y:FOR</b> on page 366
Sets the response value scale per graticule trace.	DISP:TRAC{1-21}:Y:PDIV	None (Cannot set a scale using a scale ratio.)
Sets the value of the reference line.	DISP:TRAC{1-21}:Y:RLEV	<b>DISP:TRAC{1-5}:Y:RLEV</b> on page 369
Sets the position of the reference line on the graticule of a Cartesian display.	DISP:TRAC{1-21}:Y:RPOS	<b>DISP:TRAC{1-3}:Y:RPOS</b> on page 370
Defines the top border of the display and adjusts the scale value.	DISP:TRAC{1-21}:Y:TOP	<b>DISP:TRAC{1-3}:Y:TOP</b> on page 372
Sets the Y-axis to LINear or LOGarithmic.	DISP:TRAC{1-21}:Y:SPAC	<b>DISP:TRAC{1-3}:Y:SPAC</b> on page 371
Defines the Y-axis unit of the graticule for the user trace.	DISP:TRAC{1-21}:Y:UNIT	None (No concept of user trace.)

FORMat subsystem:

4291B feature	4291B GPIB command	E4991A GPIB command
Sets the format to transfer data via GPIB.	FORM	<b>FORM:DATA</b> on page 374

HCOPY subsystem:

4291B feature	4291B GPIB command	E4991A GPIB command
Aborts print in progress.	HCOP:ABOR	<b>HCOP:ABOR</b> on page 380
Sets the printing parameters to their default values.	HCOP:DEF	None
Sets the default colors or the colors as close as possible to the display colors for printing a hard copy.	HCOP:DEV:CMAP:COL	<b>HCOP:IMAG</b> on page 381
Sets the print command to color printing.	HCOP:DEV:COL	<b>HCOP:IMAG</b> on page 381
Specifies the resolution of a printer used for printing by dpi.	HCOP:DEV:DPI	None (Set with the printer driver.)
Sets the printer ON or OFF for delivering printed paper each time printing an entire screen is finished.	HCOP:DEV:FORMF	None (Paper feed will be performed.)
Sets the orientation of paper to landscape or not using ON or OFF.	HCOP:DEV:LAND	None (Set with the printer driver.)
Specifies the left margin of printing by inch.	HCOP:DEV:LEFTM	
Sets printing of the softkeys displayed on the screen ON or OFF.	HCOP:DEV:SKEY	
Specifies the top margin of printing in inches.	HCOP:DEV:TOPM	
Executes printing.	HCOP	<b>HCOP</b> on page 380
Turns printing time and date (the time stamp function) ON or OFF.	HCOP:ITEM:TDST:STAT	None

INITiate subsystem:

4291B feature	4291B GPIB command	E4991A GPIB command
Initiates the trigger system continuously.	INIT:CONT	<b>INIT:CONT</b> on page 382
Initiates trigger system.	INIT	<b>INIT</b> on page 382
Aborts the sweep in progress to exit to the idle state and initiates the trigger system again.	INIT:AGAL:ALL	None



Table of corresponding 4291B vs. E4991A GPIB commands  
**Table of Corresponding GPIB Commands**

INSTrument subsystem:

4291B feature	4291B GPIB command	E4991A GPIB command
Selects the active channel.	INST {CH1 CH2}	None (No concept of channel.)  With the E4991A, uses the following command when the trace is set to active trace.  <b>DISP:TRAC{1-5}:SEL</b> on page 358
Sets the channel coupling of stimulus values.	INST:COUP	None (No concept of channel.)
Selects the active channel.	INST:NSEL	None (No concept of channel.)  With the E4991A, uses the following command to set the trace to active trace.  <b>DISP:TRAC{1-5}:SEL</b> on page 358
Displays the selected channel.	INST:STAT	None (No concept of channel.)  With the E4991A, uses the following command to display the selected trace.  <b>DISP:TRAC{1-5}</b> on page 356

MMEMory subsystem:

4291B feature	4291B GPIB command	E4991A GPIB command
Changes the current directory of a DOS formatted disk.	MMEM:CDIR	<b>MMEM:CDIR</b> on page 383
Copies files.	MMEM:COPY	<b>MMEM:COPY</b> on page 384
Creates a new directory in a DOS formatted disk.	MMEM:CRE:DIR	<b>MMEM:MDIR</b> on page 386
Removes the files.	MMEM:DEL	<b>MMEM:DEL</b> on page 384
Initialize the disk in floppy disk drive or memory disk.	MMEM:INIT	None (Cannot format a floppy disk. In addition, a memory disk is not loaded.)
Loads the instrument states.	MMEM:LOAD:STAT	<b>MMEM:LOAD</b> on page 385
Loads data.	MMEM:LOAD:TRAC	<b>MMEM:LOAD:TRAC</b> on page 386
Saves the graphic image on the screen as a TIFF file.	MMEM:STOR:DINT:TIFF	Uses the following commands. However, it cannot save in TIFF format but only in JPEG/BMP format.  <b>MMEM:STOR:GRAP</b> on page 389 <b>MMEM:STOR:GRAP:BMP</b> on page 390
Saves data arrays as an ASCII file.	MMEM:STOR:DINT:TRAC	<b>MMEM:STOR:TRAC:ASC</b> on page 391
Returns information on the current states of the data arrays that are saved.	MMEM:STOR:ITEM:TRAC:CAT?	None
Selects the items that are not to be saved.	MMEM:STOR:ITEM:TRAC:DEL	<b>MMEM:STOR:TRAC:SEL{1-4}</b> on page 392
Selects the items to be saved.	MMEM:STOR:ITEM:TRAC:SEL	
Saves only the instrument states and the calibration coefficients.	MMEM:STOR:STAT	The following command is used, but data other than the equipment condition and calibration coefficient will also be saved together.  <b>MMEM:STOR</b> on page 388

D. Table of corresponding 4291B vs. E4991A GPIB commands

Table of corresponding 4291B vs. E4991A GPIB commands  
**Table of Corresponding GPIB Commands**

4291B feature	4291B GPIB command	E4991A GPIB command
Save data arrays that are defined by the MMEMory:STORe:ITeM:TRACe subsystem commands.	MMEM:STOR:TRAC	Uses the following format to save in a specified data format.  <b>MMEM:STOR:TRAC</b> on page 391 <b>MMEM:STOR:TRAC:ASC</b> on page 391

PROGram subsystem:

4291B feature	4291B GPIB command	E4991A GPIB command
Returns the defined program name.	PROG:CAT?	The E4991A has a macro function (E4991A VBA) instead of Instrument BASIC.  <b>PROG:CAT?</b> on page 394
Creates and downloads program from an external controller to Instrument BASIC.	PROG:DEF	None
Deletes I-BASIC program in the analyzer.	PROG:DEL	
Deletes all I-BASIC program in the analyzer.	PROG:DEL:ALL	
Executes the program command.	PROG:EXEC	
Performs no practical function for the analyzer.	PROG:MALL	
Define the program name.	PROG:NAME	<b>PROG:NAME</b> on page 394
Sets or queries the contents of numeric program variables and arrays in the I-BASIC of the analyzer.	PROG:NUMB	None
Sets or queries the state of the program in the analyzer.	PROG:STAT	<b>PROG:STAT</b> on page 395
Sets or queries the contents of the string program variables and array of the I-BASIC of the analyzer.	PROG:STR	None
Causes no further commands or queries to be executed until the program in the analyzer exits from the RUN state.	PROG:WAIT	<b>PROG:WAIT</b> on page 395
Creates and downloads program from an external controller to Instrument BASIC.	PROG:EXPL:DEF	None
Deletes I-BASIC program in the analyzer.	PROG:EXPL:DEL	
Executes the program command.	PROG:EXPL:EXEC	
Performs no practical function for the analyzer.	PROG:EXPL:MALL	
Define the program name.	PROG:EXPL:NAME	
Sets or queries the contents of numeric program variables and arrays in the I-BASIC of the analyzer.	PROG:EXPL:NUMB	
Sets or queries the state of the program in the analyzer.	PROG:EXPL:STAT	
Sets or queries the contents of the string program variables and array of the I-BASIC of the analyzer.	PROG:EXPL:STR	
Causes no further commands or queries to be executed until the program in the analyzer exits from the RUN state.	PROG:EXPL:WAIT	

SENSe subsystem:

4291B feature	4291B GPIB command	E4991A GPIB command
Sets the point averaging factor for the active channel.	SENS:AVeR1:COUN	<b>AVeR:COUN</b> on page 288
Sets the point averaging of the active channel ON or OFF.	SENS:AVeR1	<b>AVeR</b> on page 287
Resets the averaging and restarts the sweep count at 1 at the beginning of the next sweep on the active channel.	SENS:AVeR2:CLE	<b>CALC:AVeR:CLE</b> on page 289

Table of corresponding 4291B vs. E4991A GPIB commands  
**Table of Corresponding GPIB Commands**

4291B feature	4291B GPIB command	E4991A GPIB command
Sets the sweep averaging factor for the active channel.	SENS:AVER2:COUN	<b>CALC:AVER:COUN</b> on page 290
Turns the sweep averaging factor ON or OFF for the active channel.	SENS:AVER2	<b>CALC:AVER</b> on page 289
Sets the calibration kit.	SENS:CORR1:CKIT	<b>SENS:CORR1:CKIT</b> on page 420
Defines a label of the user-modified calibration kit.	SENS:CORR1:CKIT:LAB	None
Stores the user-modified calibration kit into memory.	SENS:CORR1:CKIT:SAVE	None (However, can save a defined value in the user-defined calibration kit in the state file.)
Enters the capacitance value of the OPEN standard that is used in the user-modified calibration kit.	SENS:CORR1:CKIT:STAN1:C	<b>SENS:CORR1:CKIT:STAN1:C</b> on page 422
Enters the conductance value of the OPEN standard that is used in the user-modified calibration kit.	SENS:CORR1:CKIT:STAN1:G	<b>SENS:CORR1:CKIT:STAN1:G</b> on page 423
Enters the inductance value of the SHORT standard that is used in the user-modified calibration kit.	SENS:CORR1:CKIT:STAN2:L	<b>SENS:CORR1:CKIT:STAN2:L</b> on page 426
Enters the resistance value of the SHORT standard that is used in the user-modified calibration kit.	SENS:CORR1:CKIT:STAN2:R	<b>SENS:CORR1:CKIT:STAN2:R</b> on page 429
Enters the resistance value of the LOAD standard that is used in the user-modified calibration kit.	SENS:CORR1:CKIT:STAN3:R	<b>SENS:CORR1:CKIT:STAN3:R</b> on page 433
Enters the reactance value of the LOAD standard that is used in the user-modified calibration kit.	SENS:CORR1:CKIT:STAN3:X	<b>SENS:CORR1:CKIT:STAN3:L</b> on page 430  (However, uses a reactance value for setting.)
Selects and acquires the calibration.	SENS:CORR1:COLL	<b>SENS:CORR1:COLL</b> on page 437
Selects the frequency points where the calibration data is collected.	SENS:CORR1:COLL:FPO	<b>SENS:CORR1:COLL:FPO</b> on page 438
Calculates the error-correction coefficients from the calibration data and stores the coefficients.	SENS:CORR1:COLL:SAVE	<b>SENS:CORR1:COLL:SAVE</b> on page 439
Sets the port extension ON or OFF.	SENS:CORR1:EDEL:STAT	Uses the following command to set the off-set delay time, except for the test fixture electrical length, and at the same time sets ON the compensation function.  <b>SENS:CORR2:EDEL:TIME</b> on page 453
Sets the port extension value.	SENS:CORR1:EDEL	
Queries to determine if the correction state is ON or OFF.	SENS:CORR1?	<b>SENS:CORR1</b> on page 419
Defines the label for the user-modified compensation kit.	SENS:CORR2:CKIT:LAB	None
Stores the user-modified compensation kit into memory.	SENS:CORR2:CKIT:SAVE	None (However, can save the standard value for the fixture compensation in a state file.)
Enters the capacitance value of the OPEN standard that is used in OPEN compensation.	SENS:CORR2:CKIT:STAN1:C	<b>SENS:CORR2:CKIT:STAN1:C</b> on page 441
Enters the conductance value of the OPEN standard that is used in OPEN compensation.	SENS:CORR2:CKIT:STAN1:G	<b>SENS:CORR2:CKIT:STAN1:G</b> on page 442
Selects the fixture compensation open standard.	SENS:CORR2:CKIT:STAN1	<b>SENS:CORR2:CKIT:LIST</b> on page 440  (However, cannot choose open/short alone.)
Enters the inductance value of the SHORT standard that is used in SHORT compensation.	SENS:CORR2:CKIT:STAN2:L	<b>SENS:CORR2:CKIT:STAN2:L</b> on page 445
Enters the resistance value of the SHORT standard that is used in SHORT compensation.	SENS:CORR2:CKIT:STAN2:R	<b>SENS:CORR2:CKIT:STAN2:R</b> on page 448

D. Table of corresponding 4291B vs. E4991A GPIB commands

Table of corresponding 4291B vs. E4991A GPIB commands  
**Table of Corresponding GPIB Commands**

4291B feature	4291B GPIB command	E4991A GPIB command
Selects the fixture compensation short standard.	SENS:CORR2:CKIT:STAN2	<b>SENS:CORR2:CKIT:LIST</b> on page 440  (However, cannot choose open/short alone.)
Enters the inductance value of the LOAD standard that is used in LOAD compensation.	SENS:CORR2:CKIT:STAN3:L	None (No concept of the load compensation function.)
Enters the resistance value of the LOAD standard that is used in LOAD compensation.	SENS:CORR2:CKIT:STAN3:R	
Selects the fixture compensation load standard.	SENS:CORR2:CKIT:STAN3	
Selects the load standard used for the dielectric material test fixture compensation.	SENS:CORR2:CKIT2	The following command is used to choose a calibration kit in a dielectric material measurement.  <b>SENS:CORR1:CKIT</b> on page 420
Defines the label of the user-modified compensation kit for the permittivity measurement.	SENS:CORR2:CKIT2:LAB	None
Stores the user-modified compensation kit for the permittivity measurement into memory.	SENS:CORR2:CKIT2:SAVE	None (However, can save a user-defined load standard value in the state file.)
Enters the relative permittivity value of the LOAD standard that is used in LOAD compensation for the permittivity measurement.	SENS:CORR2:CKIT2:STAN6:PRE	<b>SENS:CORR1:CKIT:STAN7:PRE</b> on page 435
Enters the relative dielectric loss index value of user-modified LOAD standard that is used in LOAD compensation for the permittivity measurement.	SENS:CORR2:CKIT2:STAN6:PLF	<b>SENS:CORR1:CKIT:STAN7:PLF</b> on page 434
Enters the thickness value of user-modified LOAD standard that is used in LOAD compensation for the permittivity measurement.	SENS:CORR2:CKIT2:STAN6:THIC	<b>SENS:CORR1:CKIT:STAN7:THIC</b> on page 436
Measures the standard for the fixture compensation.	SENS:CORR2:COLL	<b>SENS:CORR2:COLL</b> on page 449
Selects the frequency points where the correction data is corrected.	SENS:CORR2:COLL:FPO	<b>SENS:CORR2:COLL:FPO</b> on page 450
Calculates the fixture compensation coefficients and stores the coefficients.	SENS:CORR2:COLL:SAVE	<b>SENS:CORR2:COLL:SAVE</b> on page 451
Sets the OPEN fixture compensation ON or OFF.	SENS:CORR2:OPEN	<b>SENS:CORR2:COLL:OPEN</b> on page 451
Sets the SHORT fixture compensation ON or OFF.	SENS:CORR2:SHOR	<b>SENS:CORR2:COLL:SHOR</b> on page 452
Sets the LOAD fixture compensation ON or OFF.	SENS:CORR2:LOAD	None (No concept of the load compensation function.)
Defines the center frequency value of the stimulus range.	SENS:FREQ:CENT	<b>FREQ:CENT</b> on page 376
Sets the frequency center value to the difference value between the marker and the delta marker values.		None
Sets the frequency center value of the marker.		<b>CALC{1-5}:MARK:SET</b> on page 336
Searches for a peak using the marker and then changes the CENTER to the frequency value of that peak.		Combines the following commands in execution.  <b>CALC{1-5}:MARK:FUNC:EXEC</b> on page 321  <b>CALC{1-5}:MARK:SET</b> on page 336
Selects the sweep type.	SENS:FREQ:MODE	<b>SWE:TYPE</b> on page 515

Table of corresponding 4291B vs. E4991A GPIB commands  
**Table of Corresponding GPIB Commands**

4291B feature	4291B GPIB command	E4991A GPIB command
Sets the frequency span.	SENS:FREQ:SPAN	<b>FREQ:SPAN</b> on page 377
Sets the frequency span value of the difference between the marker and the delta marker values.		<b>CALC{1-5}:MARK:SET</b> on page 336
Sets the frequency span value of the "frequency span × zooming aperture".		None (No zooming function for sweep span.)
Sets the start frequency value.	SENS:FREQ:STAR	<b>FREQ:STAR</b> on page 378
Sets the start frequency value of the sweep parameter value of the marker.		<b>CALC{1-5}:MARK:SET</b> on page 336
Sets the stop frequency value.	SENS:FREQ:STOP	<b>FREQ:STOP</b> on page 379
Sets the stop frequency value of the sweep parameter value of the marker.		<b>CALC{1-5}:MARK:SET</b> on page 336
Clears the entire list.	SENS:LIST:CLE	<b>SEGM:DEL:ALL</b> on page 406
Completes editing the frequency sweep list.	SENS:LIST:SAVE	None (No need to declare.)
Selects the segment to edit.	SENS:LIST:SEGM	None (Specifies a segment number in the GPIB command for the segment to edit.)
Adds a new segment to a list sweep table.	SENS:LIST:SEGM:ADD	None ( <b>SEGM:COUN</b> on page 397 command is used to clear a table and add a new segment.)
Sets the point averaging factor for the list sweep table.	SENS:LIST:SEGM:AVER:COUN	<b>SEGM{1-16}:AVER:COUN</b> on page 396
Sets the OSC level for the list sweep table to Ampere.	SENS:LIST:SEGM:CURR	<b>SEGM{1-16}:CURR</b> on page 398
Deletes the segments.	SENS:LIST:SEGM:DEL	None (Only a method to delete all the segments at once is available.)
Edits the segments.	SENS:LIST:SEGM:EDIT	None (However, it is necessary to create a segment in the segment sweep table using the following command before editing the segment.)  <b>SEGM:COUN</b> on page 397
Sets to center the frequency value of the segment in the list sweep table.	SENS:LIST:SEGM:FREQ:CENT	<b>SEGM{1-16}:FREQ:CENT</b> on page 407
Sets the frequency span of the segment.	SENS:LIST:SEGM:FREQ:SPAN	<b>SEGM{1-16}:FREQ:SPAN</b> on page 408
Sets the start frequency value of the segment in the list sweep table.	SENS:LIST:SEGM:FREQ:STAR	<b>SEGM{1-16}:FREQ:STAR</b> on page 409
Sets the start frequency value of the sweep parameter value of the marker.		None
Sets the stop frequency value of the segment in the list sweep table.	SENS:LIST:SEGM:FREQ:STOP	<b>SEGM{1-16}:FREQ:STOP</b> on page 410
Sets the stop frequency value of the sweep parameter value of the marker.		None
Sets the number of points for the segment for the list sweep table.	SENS:LIST:SEGM:POIN	<b>SEGM{1-16}:SWE:POIN</b> on page 413
Sets the OSC level for the list sweep table to dBm.	SENS:LIST:SEGM:POW	<b>SEGM{1-16}:POW</b> on page 411
Quits editing a segment of the list sweep table.	SENS:LIST:SEGM:QUIT	None (No need to declare.)
Completes modifying a segment in a list sweep table.	SENS:LIST:SEGM:SAVE	
Sets the OSC level for a list sweep table with the unit of Volt.	SENS:LIST:SEGM:VOLT	<b>SEGM{1-16}:VOLT</b> on page 414
Defines number of sweeps.	SENS:SWE:COUN	None (However, if the sweep averaging function is on, one trigger will perform a sweep of the specified number of averagings.)
Defines point delay times.	SENS:SWE:DWEL1	<b>SWE:DWEL2</b> on page 509

D. Table of corresponding 4291B vs. E4991A GPIB commands

Table of corresponding 4291B vs. E4991A GPIB commands  
**Table of Corresponding GPIB Commands**

4291B feature	4291B GPIB command	E4991A GPIB command
Defines the sweep delay times.	SENS:SWE:DWEL2	<b>SWE:DWEL1</b> on page 508
Sets the automatic or manual point delay time.	SENS:SWE:DWEL1:AUTO	None (Delay value = 0 seconds corresponds to the automatic setting for the 4291B.)
Sets the automatic or manual sweep delay time.	SENS:SWE:DWEL2:AUTO	
Sets number of points	SENS:SWE:POIN	<b>SWE:POIN</b> on page 511
Selects the sweep type.	SENS:SWE:SPAC	<b>SWE:TYPE</b> on page 515  (However, it is necessary to choose a sweep type in combination with the sweep parameter.)
Sets the sweep time.	SENS:SWE:TIME	<b>SWE:TIME</b> on page 513
Sets the automatic or manual sweep time.	SENS:SWE:TIME:AUTO	<b>SWE:TIME:AUTO</b> on page 514

SOURce subsystem:

4291B feature	4291B GPIB command	E4991A GPIB command
Sets the frequency.	SOUR1:FREQ	<b>FREQ</b> on page 375
Sets the OSC current level for a frequency sweep.	SOUR1:CURR	<b>SOUR:CURR</b> on page 457
Sets the OSC power level for a frequency sweep.	SOUR1:POW	<b>SOUR:POW</b> on page 470
Selects a sweep direction of UP or DOWN when in the OSC level sweep mode.	SOUR1:SWE:DIR	<b>SWE:DIR</b> on page 508
Selects the sweep type in the OSC level sweep.	SOUR1:SWE:SPAC	None (The sweep type is fixed to the linear sweep for the oscillator level sweep.)
Sets the OSC voltage level sweep center value.	SOUR1:VOLT:CENT	<b>SOUR:VOLT:CENT</b> on page 477
Sets the OSC voltage level sweep center value to the difference between the marker and the delta marker values.		None
Sets the OSC voltage level sweep center value of the marker.		<b>CALC{1-5}:MARK:SET</b> on page 336
Search for a peak using the marker and then changes the CENTER to the OSC voltage level sweep value of that peak.		The following commands are combined in execution.  <b>CALC{1-5}:MARK:FUNC:EXEC</b> on page 321 <b>CALC{1-5}:MARK:SET</b> on page 336
Sets the OSC voltage level for frequency/DC-I/DC-V sweep.	SOUR1:VOLT	<b>SOUR:VOLT</b> on page 476
Selects the sweep source.	SOUR1:VOLT:MODE	None (uses <b>SWE:TYPE</b> on page 515 to set the sweep parameter.)
Sets the OSC voltage level sweep span value.	SOUR1:VOLT:SPAN	<b>SOUR:VOLT:SPAN</b> on page 486
Sets the OSC voltage level sweep span value to the difference value between the marker and the delta marker values.		<b>CALC{1-5}:MARK:SET</b> on page 336
Sets the OSC voltage level sweep span value of the "OSC level span × zooming aperture".		None (No zooming function for sweep span.)
Sets the OSC voltage level sweep start value.	SOUR1:VOLT:STAR	<b>SOUR:VOLT:STAR</b> on page 487
Sets the OSC voltage level sweep start value of the marker.		<b>CALC{1-5}:MARK:SET</b> on page 336
Sets the OSC voltage level sweep stop value.	SOUR1:VOLT:STOP	<b>SOUR:VOLT:STOP</b> on page 488
Sets the OSC voltage level sweep stop value of the marker.		<b>CALC{1-5}:MARK:SET</b> on page 336

Table of corresponding 4291B vs. E4991A GPIB commands  
**Table of Corresponding GPIB Commands**

4291B feature	4291B GPIB command	E4991A GPIB command
Sets dc bias mode to the current setting mode.	SOUR2:CURR:ALC	None (Uses <b>SWE:TYPE</b> on page 515 to set the sweep parameter at DC bias current sweep. In addition, uses <b>SEGM:CURR:OFFS:STAT</b> on page 399 for segment sweep when setting the fixed current source mode and <b>SOUR:CURR:OFFS:STAT</b> on page 465 for settings other than the segment sweep.)
Sets the dc bias sweep current center value.	SOUR2:CURR:CENT	<b>SOUR:CURR:OFFS:CENT</b> on page 462
Sets the OSC current level sweep center value to the difference between the marker and the delta marker values.		None
Sets the OSC current level sweep center value of the marker.		<b>CALC{1-5}:MARK:SET</b> on page 336
Searches for a peak using the marker and then changes the CENTER to the OSC current level sweep value of that peak.		Combines the following commands in execution. <b>CALC{1-5}:MARK:FUNC:EXEC</b> on page 321 <b>CALC{1-5}:MARK:SET</b> on page 336
Sets dc bias current value.	SOUR2:CURR	<b>SOUR:CURR:OFFS</b> on page 461
Sets the current limit in the dc bias sweep mode.	SOUR2:CURR:LIM	<b>SOUR:CURR:LIM:OFFS</b> on page 459
Selects the sweep source.	SOUR2:CURR:MODE	None (Uses <b>SWE:TYPE</b> on page 515 command to set the sweep parameter.)
Sets the OSC current level sweep span value.	SOUR2:CURR:SPAN	<b>SOUR:CURR:OFFS:SPAN</b> on page 463
Sets the OSC current level sweep span value to the difference between the marker and the delta marker values.		<b>CALC{1-5}:MARK:SET</b> on page 336
Sets the OSC current level sweep span value of the "OSC level span × zooming aperture".		None (No zooming function for the sweep span.)
Sets the OSC current level sweep start value.	SOUR2:CURR:STAR	<b>SOUR:CURR:OFFS:STAR</b> on page 464
Sets the OSC current level sweep start value of the marker.		<b>CALC{1-5}:MARK:SET</b> on page 336
Sets the dc bias output ON or OFF.	SOUR2:CURR:STAT	<b>SOUR:CURR:OFFS:STAT</b> on page 465
Sets the OSC current level sweep stop value.	SOUR2:CURR:STOP	<b>SOUR:CURR:OFFS:STOP</b> on page 466
Sets the OSC current level sweep stop value of the marker.		<b>CALC{1-5}:MARK:SET</b> on page 336
Sets dc bias mode to the voltage setting mode.	SOUR2:VOLT:ALC	None (Use <b>SWE:TYPE</b> on page 515 to set the sweep parameter at the DC bias voltage sweep. In addition, uses <b>SEGM:VOLT:OFFS:STAT</b> on page 417 for the segment sweep when setting at the fixed voltage source mode and <b>SOUR:VOLT:OFFS:STAT</b> on page 484 for settings other than the segment sweep.)

D. Table of corresponding 4291B vs. E4991A GPIB commands

Table of corresponding 4291B vs. E4991A GPIB commands  
**Table of Corresponding GPIB Commands**

4291B feature	4291B GPIB command	E4991A GPIB command
Sets the dc bias sweep voltage center value.	SOUR2:VOLT:CENT	<b>SOUR:VOLT:OFFS:CENT</b> on page 481
Sets the OSC voltage level sweep center value to the difference between the marker and the delta marker values.		<b>CALC{1-5}:MARK:SET</b> on page 336
Sets the OSC voltage level sweep center value of the marker.		None
Searches for a peak using the marker and then changes the CENTER to the OSC voltage level sweep value of that peak.		Combines the following commands in execution. <b>CALC{1-5}:MARK:FUNC:EXEC</b> on page 321 <b>CALC{1-5}:MARK:SET</b> on page 336
Sets dc bias voltage value.	SOUR2:VOLT	<b>SOUR:VOLT:OFFS</b> command on page 480
Sets the voltage limit in the dc bias sweep mode.	SOUR2:VOLT:LIM	<b>SOUR:VOLT:LIM:OFFS</b> on page 478
Selects the sweep source.	SOUR2:VOLT:MODE	None (Uses the <b>SWE:TYPE</b> on page 515 command to set the sweep parameter.)
Sets the OSC voltage level sweep span value.	SOUR2:VOLT:SPAN	<b>SOUR:VOLT:OFFS:SPAN</b> on page 482
Sets the OSC voltage level sweep span value to the difference between the marker and the delta marker values.		<b>CALC{1-5}:MARK:SET</b> on page 336
Sets the OSC voltage level sweep span value of the "OSC level span × zooming aperture".		None (No zooming function for the sweep span.)
Sets the OSC voltage level sweep start value.	SOUR2:VOLT:STAR	<b>SOUR:VOLT:OFFS:STAR</b> on page 483
Sets the OSC voltage level sweep start value of the marker.		<b>CALC{1-5}:MARK:SET</b> on page 336
Sets the dc bias output ON or OFF.	SOUR2:VOLT:STAT	<b>SOUR:VOLT:OFFS:STAT</b> on page 484
Sets the OSC voltage level sweep stop value.	SOUR2:VOLT:STOP	<b>SOUR:VOLT:OFFS:STOP</b> on page 485
Sets the OSC voltage level sweep stop value of the marker.		<b>CALC{1-5}:MARK:SET</b> on page 336
Selects the sweep direction when in the dc bias sweep mode.	SOUR2:SWE:DIR	<b>SWE:DIR</b> on page 508
Selects the sweep type in dc bias sweep.	SOUR2:SWE:SPAC	None (The sweep type for the dc bias sweep is fixed to a linear sweep.)

STATus subsystem:

4291B feature	4291B GPIB command	E4991A GPIB command
Sets the contents of the Instrument Event Status Enable Register.	STAT:INST:ENAB	None (No instrument event status effective register.)
Returns the contents of the Instrument Event Status Register.	STAT:INST?	
Queries the contents of Operation Status Condition Register.	STAT:OPER:COND?	<b>STAT:OPER:COND?</b> on page 489
Sets the contents of the Operation Status Enable Register.	STAT:OPER:ENAB	<b>STAT:OPER:ENAB</b> on page 490
Queries the contents of the Operation Status Event Register.	STAT:OPER?	<b>STAT:OPER?</b> on page 489



Table of corresponding 4291B vs. E4991A GPIB commands  
**Table of Corresponding GPIB Commands**

4291B feature	4291B GPIB command	E4991A GPIB command
Sets the negative transition filter of the Operation Status Register.	STAT:OPER:NTR	<b>STAT:OPER:NTR</b> on page 491
Sets the positive transition filter of the Operation Status Register.	STAT:OPER:PTR	<b>STAT:OPER:PTR</b> on page 492
Presets the Operation and Questionable Status Enable Registers and transition filters.	STAT:PRES	<b>STAT:PRES</b> on page 493
Queries the contents of the Questionable Status Condition Register.	STAT:QUES:COND?	<b>STAT:QUES:COND?</b> on page 493
Sets the value of the Questionable Status Enable Register.	STAT:QUES:ENAB	<b>STAT:QUES:ENAB</b> on page 494
Queries the contents of the Questionable Event Status Register.	STAT:QUES?	<b>STAT:QUES?</b> on page 493

SYSTem subsystem:

4291B feature	4291B GPIB command	E4991A GPIB command
Sets an annunciator that sounds to indicate completion of a certain operation.	SYST:BEEP1:STAT	<b>SYST:BEEP:STAT</b> on page 516
Sets an annunciator that sounds as a warning.	SYST:BEEP2:STAT	
Sets the GPIB address that the analyzer will use to communicate with the external controller.	SYST:COMM:GPIB:CONT:ADDR	None
Reads data from 4-bit parallel input of the analyzer.	SYST:COMM:PAR:DATA?	None (Parallel I/O not loaded.)
Outputs data to the 8-bit parallel output port.	SYST:COMM:PAR:TRAN:DATA	
Sets the date of the internal clock.	SYST:DATE	<b>SYST:DATE</b> on page 517
Changes the displayed date.	SYST:DATE:MODE	None
Outputs the error message in the error queue.	SYST:ERR?	<b>SYST:ERR?</b> on page 517
Specifies the fixture in use in order to select which electrical length is to be used.	SYST:FIXT	<b>SENS:CORR2:FIXT</b> on page 454
Sets the electrical length of the user-modified fixture.	SYST:FIXT:DIST	<b>SENS:CORR2:FIXT:EDEL:USER:DIST</b> on page 456
Modifies the label of the user-modified fixture.	SYST:FIXT:LAB	None
Saves the settings of the user-modified fixture.	SYST:FIXT:SAVE	None (However, can save in a state file.)
Sends the key code for a key or a softkey on the front panel.	SYST:KEY	None
Locks the front panel keys and the rotary knob.	SYST:KLOC	<b>SYST:KLOC</b> on page 522
Presets the analyzer to the preset default value.	SYST:PRES	<b>SYST:PRES</b> on page 523
Blanks the displayed frequency notation for security purposes.	SYST:SEC	None
Sets the time of the internal clock.	SYST:TIME	<b>SYST:TIME</b> on page 524
Queries the SCPI version to which the analyzer conforms.	SYST:VERS?	<b>SYST:VERS?</b> on page 524

TRACe subsystem:

4291B feature	4291B GPIB command	E4991A GPIB command
Copies the data trace into the memory trace of the active channel.	TRAC:COPY TR{2-17},TR1	None
Copies the data or the memory trace of the active channel into the user trace.	TRAC:COPY TR{18-21},TR{1-17}	None (No concept of user trace.)
Inputs data to data/memory trace arrays.	TRAC	Uses the following command to copy data to the memory trace. <b>CALC{1-5}:MATH:MEM</b> on page 341

Table of corresponding 4291B vs. E4991A GPIB commands  
**Table of Corresponding GPIB Commands**

4291B feature	4291B GPIB command	E4991A GPIB command
Inputs data to user traces.	TRAC {TRX{18-21} TRY{18-21}}	None (No concept of user trace.)
Outputs each trace's value at a specified point.	TRAC:VAL?	None (Cannot specify a measurement point to read a trace value.)
Defines the number of points of the user trace.	TRAC:POIN TR{18-21}	None (No concept of user trace.)

TRIGger subsystem:

4291B feature	4291B GPIB command	E4991A GPIB command
Selects the trigger event mode.	TRIG:EVENT:TYPE	<b>TRIG:EVENT</b> on page 525
Sets the trigger signal polarity of an external signal connected to the rear panel EXT TRIGGER input.	TRIG:SLOP	<b>TRIG:SLOP</b> on page 526
Selects the trigger source, which is common to both channels.	TRIG:SOUR	<b>TRIG:SOUR</b> on page 526

Common commands:

4291B feature	4291B GPIB command	E4991A GPIB command
Clears the Status Byte Register, the Operation Event Status Register, the Standard Event Status Register, and the Instrument Event Status Register.	*CLS	<b>*CLS</b> on page 279
Sets the enable bits of the Standard Event Register.	*ESE	<b>*ESE</b> on page 280
Returns the contents of the Standard Event Status Register.	*ESR?	<b>*ESR?</b> on page 280
Returns a string that represents the analyzer's ID.	*IDN?	<b>*IDN?</b> on page 281
Sets the Operation Completes bit to 1 when it completes all pending operations.	*OPC	<b>*OPC</b> on page 281
Returns an ASCII character 1 when all pending operations have been completed.	*OPC?	<b>*OPC?</b> on page 281
Queries the options installed.	*OPT?	<b>*OPT?</b> on page 282
Specifies the address of a controller that is temporarily passing GPIB control to the analyzer.	*PCB	None (Path control not possible.)
Resets the analyzer to its default values.	*RST	<b>*RST</b> on page 282
Sets the contents of the Status Byte Enable Register.	*SRE	<b>*SRE</b> on page 283
Returns the contents of the Status Byte Register.	*STB?	<b>*STB?</b> on page 283
Triggers the analyzer when the trigger mode is set to BUS trigger.	*TRG	<b>*TRG</b> on page 284
Executes an internal self-test and returns the test result.	*TST?	<b>*TST?</b> on page 284
Makes the analyzer wait until all previously sent commands are completed.	*WAI	<b>*WAI</b> on page 284

---

## **E**      **Complex Operation Programs**

This appendix shows sample programs for implementing complex operations in Visual Basic and HTBasic.

## Complex Operation Programs

The following section shows sample code fragments that performs addition, subtraction, multiplication, and division operations. By adding this coding to your program, it can handle addition, subtraction, multiplication, and division operations on complexes.

### Sample Implementation in Visual Basic

The following is a sample program in Visual Basic that performs addition, subtraction, multiplication, and division operations on complexes. At first, a Type statement is used to define the complex type name Complex. Then, the Function procedure is used to code addition, subtraction, multiplication, and division operations as four separate user-defined functions. The variables used in this program are as follows:

a, b                    Complexes to be operated  
c                        Variable to which an operation result is assigned  
Re, Im                 Real (Re) and imaginary (Im) components of a complex

These functions can be called from a main program.

#### Example E-1

#### Example of Complex Operation Program in Visual Basic

```
Option Explicit
Public Type Complex
    Re As Double
    Im As Double
End Type
`
` Adding Complex
`
Public Function complex_add(a As Complex, b As Complex) As Complex
    Dim c As Complex
    c.Re = a.Re + b.Re
    c.Im = a.Im + b.Im
    complex_add = c
End Function
`
` Subtracting Complex
`
Public Function complex_sub(a As Complex, b As Complex) As Complex
    Dim c As Complex
    c.Re = a.Re - b.Re
    c.Im = a.Im - b.Im
    complex_sub = c
End Function
`
` Multiplying Complex
`
Public Function complex_mul(a As Complex, b As Complex) As Complex
    Dim c As Complex
    c.Re = a.Re * b.Re - a.Im * b.Im
    c.Im = a.Re * b.Im + a.Im * b.Re
    complex_mul = c
End Function
```

```

\
\ Dividing Complex
\
Public Function complex_div(a As Complex, b As Complex) As Complex
    Dim c As Complex
    Dim de As Double
    de = b.Re ^ 2 - b.Im ^ 2
    c.Re = (a.Re * b.Re + a.Im * b.Im) / de
    c.Im = (a.Im * b.Re - a.Re * b.Im) / de
    complex_div = c
End Function

```

### Sample Implementation in HTBasic

The following is a sample program in HTBasic that performs addition, subtraction, multiplication, and division operations on complexes. The variables used in the program are as follows.

- A(\*), B(\*)            Array to be operated. The index of this array starts with 1.
- C(\*)                 Array in which operation results are stored. The index of this array starts with 1.
- Nop                  The upper limit of the index value into the array.

#### Example E-2

#### Example of Complex Operation Program in HTBasic

```

10        !
20        ! Adding Complex Arrays
30        !
40        SUB Complex_add(A(*),B(*),C(*),Nop)
50            INTEGER I,J
60            FOR I=1 TO Nop
70                FOR J=1 TO 2
80                    C(I,J)=A(I,J)+B(I,J)
90                NEXT J
100          NEXT I
110        SUBEND
120        !
130        ! Subtracting Complex Arrays
140        !
150        SUB Complex_sub(A(*),B(*),C(*),Nop)
160            INTEGER I,J
170            FOR I=1 TO Nop
180                FOR J=1 TO 2
190                    C(I,J)=A(I,J)-B(I,J)
200                NEXT J
210          NEXT I
220        SUBEND
230        !
240        ! Multiplying Complex Arrays
250        !
260        SUB Complex_mul(A(*),B(*),C(*),Nop)
270            INTEGER I
280            FOR I=1 TO Nop
290                C(I,1)=A(I,1)*B(I,1)-A(I,2)*B(I,2)
300                C(I,2)=A(I,1)*B(I,2)+A(I,2)*B(I,1)
310          NEXT I

```

## Complex Operation Programs

### Complex Operation Programs

```
320     SUBEND
330     !
340     ! Dividing Complex Arrays
350     !
360     SUB Complex_div(A(*),B(*),C(*),Nop)
370         INTEGER I
380         REAL De
390         FOR I=1 TO Nop
400             De=(B(I,1)^2-B(I,2)^2)
410             IF De=0 THEN Err
420             C(I,1)=(A(I,1)*B(I,1)+A(I,2)*B(I,2))/De
430             C(I,2)=(A(I,2)*B(I,1)-A(I,1)*B(I,2))/De
440         NEXT I
450         GOTO Ext
460 Err: DISP "DIVISION BY 0"
470 Ext: !
480     SUBEND
```

---

## **F** **List of Responses to Measurement Failure**

This appendix lists the Agilent E4991A's responses to various types of measurement failure.

## Behavior under Abnormal Measurement Conditions

This section describes abnormal conditions that may occur during measurement and explains the resulting LCD display and GPIB output and how to cope with them.

- **Overload**  
 This situation is detected when an internal circuit is temporally overloaded due to connection or disconnection of a DUT during measurement. If this failure occurs frequently during normal measurement, the instrument may be out of order.
- **DC Bias Overload**  
 This situation is detected when overcurrent suddenly runs in a bias circuit. If this failure occurs frequently during normal measurement, the instrument may be out of order.
- **PLL Unlock**  
 This situation is detected when E4991A has failed to synchronize an external reference signal. If this failure occurs frequently during normal measurement, the instrument may be out of order.
- **DC Bias Current/Voltage Limitation**  
 This situation is detected when set voltage or current cannot be applied because of limited dc bias current or voltage. This does not always indicate an instrument failure.

**Table F-1 Behavior under Abnormal Measurement Conditions**

Event	Screen display	Questionable Status Hardware Event Register	Measurement value	Suggested action
Overload	"RF Overload" appears in status line.	Bit 3 is set to 1.	Indefinite	Do not connect or disconnect the DUT during measurement.
DC bias Overload	"DC Bias Overload" appears in status line.	Bit 2 is set to 1.	Measurement is performed at a voltage other than the set DC bias voltage.	Do not connect or disconnect the DUT during measurement.
PLL Unlock	"PLL Unlock" appears in status line.	Bit 1 is set to 1.	Indefinite	If an external reference signal out of specification is input, input a signal in accordance with the specification.
DC bias current/voltage limitation is imposed	"Bias Lmt" appears in DC bias status.	N/A	Measurement is performed at limited DC bias voltage/current.	Change the maximum current limit or maximum voltage limit.



---

## **G** Messages

The Agilent E4991A provides error messages as well as messages that indicate the internal operating status of the equipment. This appendix describes such messages in order of error number. To search for E4991A error messages in alphabetical order, please refer to the *Operation Manual*.

## Messages

### Error number: 0

Messages showing the status of the E4991A are displayed in the lower left of the E4991A LCD screen. The messages include error messages that occur during the execution of GPIB commands and others that indicate the internal status of the equipment.

Error messages are indicated following the character string “[Err]”, and can be read out by a GPIB command. On the other hand, messages other than these are indicated without the “[Err]” character string, and cannot be read out using a GPIB command. In this section the content and method of resolving each message will be explained.

---

## Order of Error Number

Errors with a negative error numbers are basically general errors for GPIB instruments defined by IEEE488.2. On the other hand, errors with a positive error numbers are ones defined specifically for the E4991A.

0

### (no error)

No error has occurred.

This message will not be shown on the LCD display but rather, when **SYST:ERR?** command on page 517 has been sent on GPIB, in case when the equipment find no occurrence of an error, the message will be returned as an error number 0.

6

### Additional standards needed

Before ending all data measurement requiring the calculation of calibration factors, a GPIB command has been sent to turn the calibration function On. For example, when the measurement of Open Standard and Short Standard of the calibration kit is in full completion, **SENS:CORR1:COLL:SAVE** command on page 439 was attempted to be used to set the calibration function On.

Measure all the necessary calibration data.

7

### Calibration required

During when the calibration function has not been set to On, a GPIB command, which is only possible to be executed while the calibration function is On, has been sent. For example, during when the calibration function is Off, **SENS:CORR2:COLL** command on page 449 has been used to attempt measuring fixture compensation data.

After measuring all necessary data, turn the calibration function On.

10

### Cal measure aborted

One of the following problems has occurred.

- During the measurement of necessary calibration/fixture compensation data, or during and after the calculation of calibration/fixture compensation factors (with calibration function turned On), setting for calibration/fixture compensation data acquired points (**Fixed, Full Range, Fixed, User Pwr** or **User Freq & Pwr**) has been altered. All measured calibration/fixture compensation data acquired thus far, or calibration/fixture compensation function have been invalidated.
- While the calibration/fixture compensation data acquired point setting is in the user defined point condition (**User Freq & Pwr**), during the measurement of necessary calibration/fixture compensation data, and during and after the calculation of calibration/fixture compensation factors (with the calibration function turned On), sweep condition (Sweep Range, Sweep Parameter, Measurement Points and Sweep Type) have been altered. All measured calibration/fixture compensation data acquired thus far, or calibration/fixture compensation function have been invalidated.
- During the measurement of necessary calibration data, the measurement had been interrupted by **Abort Cal Meas** button. The calibration data had been invalidated.

In order to recover the calibration/fixture compensation function or the equipment setting, which were valid just prior to the event, click **Recover Cal/Compen** State button. Also, if necessary, retry the measurement of calibration/fixture compensation data.

11

### Compensation required

Before finishing the measurement of fixture compensation data, a command has been sent to turn the fixture compensation function On. For example, when during the measurement of Open Compensation Data has not yet finished, **SENS:CORR2:COLL:OPEN** command on page 451 have been used to attempt setting the Open Compensation Function in the fixture compensation functions to On.

Measure necessary fixture compensation data.

13

### Comp measure aborted

During the measurement of necessary fixture compensation data, the measurement has been interrupted by **Abort Compen Meas** button. The fixture compensation data has been invalidated.

Retry measuring the fixture compensation data if necessary.

14

### Not allowed in power sweep

Invalid command has been sent to the oscillator level sweep while in process. For example, during the oscillator level sweep, **SWE:TYPE** command on page 515 has been used to attempt setting the sweep type to log sweep. This operation is invalidated during the oscillator level sweep.

Check to see if the command is valid toward the oscillator level sweep.

15

### User cal mode only

Before selecting a user defined calibration kit as the calibration kit, setting has been attempted by using command defining each standard of the calibration kit.

First, set the calibration kit that will be used as the user defined calibration kit and afterwards, define each standard rate for the calibration kit that is prepared by the user.

22

**printer error**

Printer did not respond to the control given from the E4991A.

Please check whether the printer's power is On or Off, connection status of cable, or paper supplies.

30

**No valid memory trace**

There was no data stored in the Memory Trace and **CALC{1-5}:MATH:FUNC** command on page 340 was used to attempt displaying the Memory Trace.

Before displaying the Memory Trace, use **CALC{1-5}:MATH:MEM** command on page 341 to store the data into the Memory Trace.

31

**Can't calculate equivalent parameters**

The measured data was not possible to make approximate calculation into the equivalent circuit parameters that was selected in the equivalent circuit model.

Retry to carry out measurement one more time select an appropriate equivalent circuit model.

32

**Must be more than 2 points for analysis**

Measurement points within the sweep range (if the partial search function is On, within the designated Searching range) are set to 2 and therefore, calculation of equivalent circuit parameter (**Calculate Parameter** button or **CALC{1-5}:EPAR** command on page 295) was not possible to be executed.

Measurement points within the sweep range (if the partial search function is On, within the designated Searching range) must be set to 3 or above.

47

**Not enough data**

The amount of data that has been transferred to the E4991A by an external controller was less than the amount expected by E4991A.

Match the amount of data to be transferred and the E4991A measurement points.

48

**Option not installed**

Due to the fact that option was not installed, the command that has been sent was ignored. For example, during when the option 001 (DC advice function) is not installed, **SOUR:VOLT:OFFS** command on page 480 is used to set up the DC advice voltage figures.

Please contact your nearest Agilent Technologies branch office or the company where you have purchased the equipment in order to make installation of necessary options.

61

**No data available on memory**

Marker's Statistic Analysis Function (**Statistics** button) is Off and an attempt was made to read out the statistic analysis result by using **CALC{1-5}:MST:DATA?** command on page 344.

Turn the Marker's Statistic Analysis Function to On and acquire data for statistic analysis.

62 **Can't execute data examination**

Even though the data for statistic analysis has been acquired, an attempt has been made to read out the statistic analysis results by changing the setting conditions (such as sweep start rate) and using **CALC{1-5}:MST:DATA?** command on page 344 before the measurement have been updated.

After changing the setting conditions, wait for the measurement to be updated, and then read out the statistic analysis results.

69 **Too many segments or points**

During editing the list sweep table, setting has been attempted which will exceed the maximum figure of segment (16), maximum figure of measurement points per 1 segment, or maximum figure of total measurement points in all segments.

When setting, number of segments or measurement points should not exceed the maximum figures.

70 **Not allowed in this measurement mode**

At present a command has been sent which is not possible to be executed in the set measurement mode. For example, in case of Dielectric Measurement Mode, **SENS:CORR1:CKIT** command on page 420 has been used in order to set the calibration kit to used defined calibration kit.

Select a measurement mode will validate the command.

71 **Impedance measurement mode only**

A command has been sent which is valid for Impedance Measurement Mode only. For example, during the Magnetic Substance Measurement Mode, **SENS:CORR2:CKIT:STAN1:C** command on page 441 has been used in order to define the user defined fixture compensation kit.

Select Impedance Measurement Mode.

72 **Permittivity measurement mode only**

A command has been sent which is valid for Dielectric Measurement Mode only. For example, during the Magnetic Substance Measurement Mode, **SENS:CORR1:CKIT:STAN7:THIC** command on page 436 has been used in order to set the thickness of load standard for Dielectric Measurement.

Select Dielectric Measurement Mode.

73 **Permeability measurement mode only**

A command has been sent which is valid for Magnetic Substance Measurement Mode only. For example, during the Dielectric Measurement Mode, **CALC:FORM:PAR:MAG** command on page 302 has been used in order to set the size of the magnetic substance.

Select Magnetic Substance Measurement Mode.

77 **Invalid material size**

The definition of the size of test material in the Magnetic Substance Measurement is invalid. For example, outside diameter of the test material was attempted to set in smaller figure than the inside diameter.

Set the outside diameter of the magnetic substance bigger than that of the inside diameter.

79

**Not available for this format**

Selected measurement parameter or display format could not be executed. For example, during the Dielectric Measurement Mode or in Magnetic Substance Measurement Mode, **DISP:TRAC{1-5}:GRAT:FORM** command on page 357 has been used in order to set into unchangeable display format (Smith Chart or Admittance Chart).

Select the measurement parameter or display format which are possible to be selected.

80

**Not available for this fixture**

An invalid command has been sent toward presently selected text fixture. For example, during when the 16197A is selected, **CALC{1-5}:FORM** command on page 298 has been used in order to set into unchangeable measurement parameter (Complex dielectric constant against the complex trace).

Select the measurement parameter or display format which are possible to be selected.

90

**No marker delta - parameter not set**

Reference marker's `gpcdeltauppergpc` mode is in Off and **CALC{1-5}:MARK:SET** command on page 336 or **CALC{1-5}:MARK:FUNC:DOM:SPAN** command on page 319 have been used in order to set the `gpcdeltauppergpc` figures to span rate within the sweep range or within the partial search range.

First, use **CALC{1-5}:MARK:REF** command on page 328 to display the reference marker. Second, use **CALC{1-5}:MARK:REF:TYPE** command on page 333 to set the `gpcdeltauppergpc` Mode or Fixed `gpcdeltauppergpc` Mode to On.

92

**No active marker**

Due to the fact that marker is not displayed, the command which has been sent was ignored. For example, during when the marker is not displayed, **CALC{1-5}:MARK:SET** command on page 336 was used in attempt to change the equipment setting of the E4991A.

First use **CALC{1-5}:MARK{1-8}** command on page 304 to show marker on the display.

94

**No fixed delta marker**

Due to the fact that reference marker is not set in fixed `gpcdeltauppergpc` mode, the command which has been sent was ignored. For example, during when the fixed `gpcdeltauppergpc` mode is not set, **CALC{1-5}:MARK:REF:Y** command on page 335 is used in attempt to set the reference marker to the designated measurement rates.

First, use **CALC{1-5}:MARK:REF** command on page 328 to display the reference marker. Next, use **CALC{1-5}:MARK:REF:TYPE** command on page 333 to change the setting to fixed `gpcdeltauppergpc` mode.

95

**Frequency sweep only**

A command only valid during the sweep parameter is in frequency has been sent. For example, during when the sweep parameter is set other than the frequency, **CALC{1-5}:MARK:UNIT** command on page 337 is used in attempt to set the marker X-axis display to relaxation time ( $1/2\pi f$ ).

First, use **SWE:TYPE** command on page 515 to set the sweep parameter to frequency.

- 104           **Save error**
- During the saving of file, there was an error detected on the media in which the data is to be stored. For example, when saving the file into a floppy disk, the space available in the floppy disk was not sufficient.
- Check the space available in the media in which the data is to be stored.
- 105           **Recall error**
- During reading out (recall) a file, an error has occurred. For example, a file containing invalid data (such as the extension (.sta) equipment setting files that was saved with a equipment other than E4991A) has been attempted to read out.
- Check to see if there is no problem in the file contents.
- 106           **Invalid file name**
- During the execution of saving a file/recall command, series of characters showing a file name were inappropriate. For example, when executing a recall command, file name extension was incorrect.
- Specify an appropriate file name.
- Also, when saving data on a floppy disk, this error message will be shown if the disk is not (properly) inserted or the disk is write-protected.
- 113           **No data trace displayed**
- Due to the fact that data trace is not being displayed, a command that has been sent was ignored. For example, during when the data trace is not displayed, **CALC{1-5}:MARK:ON** command on page 327 is used in attempt to set the trace which display a marker as the data trace.
- First, use **CALC{1-5}:MATH:FUNC** command on page 340 to display the data trace.
- 114           **No memory trace displayed**
- Due to the fact that memory trace is not displayed, a command that has been sent was ignored. For example, during when the memory trace is not displayed, **DISP:TRAC{1-5}:Y:FOR** command on page 366 is used in attempt to set the scale setting subject as the data trace.
- First, use **CALC{1-5}:MATH:FUNC** command on page 340 to display the memory trace.
- 118           **Segment table empty or insufficient table**
- Due to the fact that the segment sweep table has not been created, a command that has been sent was ignored. For example, before the segment sweep table has been created, **SWE:TYPE** command on page 515 is used in attempt to set a sweep type as the segment sweep.
- Before carrying out a segment sweep, create the segment sweep table.

140

**Not allowed for the current trigger source**

Invalid command has been sent toward presently selected trigger source. For example, during when the trigger source is set on internal trigger (**Internal**), **TRIG:EVENT** command on page 525 is used in attempt to set the trigger event mode (Detecting point for putting trigger) at each and every measurement point (**On Point**) or at each and every segment (**On Segment**). This operation is valid only when the trigger source is set other than internal trigger.

After setting the trigger source to **Manual**, **External** or **GPIB Bus**, change the Trigger Event Mode.



- 100      **Command error**  
Error has occurred in which the E4991A could not grammatically specify the error message. It shows that the command error which is defined by the IEEE488.2,5.1.1.4 has occurred
- 101      **Invalid character**  
In the series of error message characters, invalid character has been found. For example, when a message "**SENS:CORR1:COLL:FPO USER**" is sent toward the proper program message; "**SENS:CORR1:COLL:FPO&USER**", the ampersand symbol (&) will be perceived by E4991A as an invalid character. In case the parameter is inputted at the end, provide space between the command and the parameter.
- 102      **Syntax error**  
There was an unrecognized command or data type. For example, when a message "**SYST:POFF**" is sent toward the proper program message; "**SYST::POFF**", a column (:) has been incorrectly inserted and it will be perceived by E4991A as unrecognized command. Delete one column (:) in order to send the appropriate command.
- 103      **Invalid separator**  
When the parser (compiler) was expecting a separating symbol, there was a character which is not a separating symbol. For example, when a message "**SENS:CORR1:COLL:FPO USER;\*OPC?**" is sent toward the proper 2 program messages with a semi-column (;) separating the two; "**SENS:CORR1:COLL:FPO USER \*OPC?**", the separating semi-column (;) will be perceived by E4991A as a space. When sending 2 program messages simultaneously, please insert a separating symbol between the two, such as semi-column (;).
- 104      **Data type error**  
The parser has recognized data element that should not supposed to exist. For example, even though a numerical figure or series of character data have been expected, a block data have been sent. Define the type of the recognized data.
- 105      **GET not allowed**  
During the receiving of program message, Group Execution Trigger (GET command in HTBasic) have been inputted (refer to IEEE488.2,7.7). For example, send a command such as "**\*OPC?**", or "**\*WAI**" which weigh the programs.
- 108      **Parameter not allowed**  
Parameter exceeded the number necessary for a command.  
For example, when a message "**SWE:TYPE LIN,SEGM**" is sent toward the proper program message;  
"**SWE:TYPE LIN**", even though the parameter required for this command is 1, 2 parameters are contained. Therefore, the number of the parameter will be regarded as invalid by E4991A. Refer to the command reference and check the number of parameters required.
- 109      **Missing parameter**  
Parameter was less than what was necessary for a command, or the parameter has not been inputted. For example, **SWE:POIN** command requires 1 parameter and thus, when a message; "**SWE:POIN**" has been sent toward the correct program message; "**SWE:POIN 201**", it will be regarded as invalid by E4991A because the parameter has not been inputted. For command which requires parameter, make sure they are inputted.

- 112           **Program mnemonic too long**
- The length of header is exceeding than 12 characters. The length of header would here refer to the length of the series of characters that are separated with the use of columns (:). Refer to IEEE488.2,7.6.4.1 for further details.
- 113           **Undefined header**
- Though the grammatical structure does not provide any problems, a command not defined by E4991A has been received. For example, when a message; "**DISP:TRAC1:X:AUTO**" has been sent toward the correct program message; "**DISP:TRAC1:Y:AUTO**", it will be received by E4991A as an undefined command. Refer to the command reference and check the correct commands.
- 120           **Numeric data error**
- Error that was caused by numeric data (including the numeric data other than 10 decimal numbers) has occurred. From error numbers - 121 to - 121 unspecified numeric error has occurred.
- 121           **Invalid character in number**
- There were invalid characters toward the received data and type. For example, within the 10 decimal numeric data, an alphabet is found, or within 8 decimal numeric data, 9 was found.
- 123           **Exponent too large**
- Absolute figure of the exponent has exceeded to over 32,000. (Refer to IEEE488.2, 7.2.4.1)
- 124           **Too many digits**
- Mantissa's number of digits in the 10 decimal numeric data element is exceeding over 255, except the preceding 0. (Refer to IEEE488.2,7.2.4)
- 128           **Numeric data not allowed**
- On the position where E4991A would not receive numeric data element, the numeric data element has been received. For example, when a message; "**CALC1:FORM 3**" has been sent toward the correct program message; "**CALC1:FORM RS**", the numeric data element will be received by E4991A as invalid. Refer to the command reference and check the parameter that should be used for this command.
- 131           **Invalid suffix**
- Suffix (here meaning Unit) is not following the sentence structure defined by IEEE488.2, 7.7.3.2, or the suffix is not appropriate for E4991A. For example, when a message; "**SOUR:VOLT:STAR 10dbm**" has been sent toward the correct program message; "**SOUR:VOLT:STAR 10mV**", the suffix will be regarded by E4991A as invalid. Refer to the command reference and check the unit that should be used for this command.
- 134           **Suffix too long**
- Suffix (here meaning Unit) display is written in over 12 characters. (Refer to IEEE488.2, 7.7.2.4)
- 138           **Suffix not allowed**
- After the numeric data in which the suffix (here meaning Unit) can not be inputted, the suffix have been added. For example, when a message; "**DISP:TRAC1:Y:PDIV 0.01rad**" has been sent toward the correct program message; "**DISP:TRAC1:Y:PDIV 0.01**", the suffix will be regarded by E4991A as invalid. Refer to the command reference and check

to see if the suffix can be added to the numeric data element.

-148

**Character data not allowed**

On the position where E4991A would not receive character data element, the character data element (not violate the standard) has been found. For example, when a message; "CALC1:MARK:FUNC:TARG MAX" has been sent toward the correct program message; "CALC1:MARK:FUNC:TARG le-12", the character data element will be regarded by E4991A as invalid. Refer to the command reference and check the parameter to be used for that command.

-150

**String data error**

Error has occurred which is caused by received series of character data element (quotation mark character). From error - 151 to - 159, unspecified error has occurred in the series of characters.

-151

**Invalid string data**

Even though the series of character data were expected, the appeared series of character is invalid for some reason. (Refer to IEEE488.2, 7.7.2.4) For example, before the closing quotation mark character has appeared, END message was received.

-158

**String data not allowed**

On the position where E4991A would not receive character data element, the character data element has been found. For example, when a message; "TRIG:SOUR "MAN"" has been sent toward the correct program message; "TRIG:SOUR MAN", the double quote (") will be regarded by E4991A as invalid. Refer to the command reference and check to see if the double quote (") is required in the parameter for that command.

-161

**Invalid block data**

Even though the block data had been expected, the appeared block data is invalid for some reason. (Refer to IEEE488.2, 7.7.6.2) For example, before the length of block data has been filled, END message was received.

-168

**Block data not allowed**

On the position where E4991A would not receive block data element, the block data element has been found.

-170

**Expression error**

During the structure analysis of the expression data, an error that does not apply in between errors -171 and - 179 has been occurred.

-171

**Invalid expression**

Expression data element is invalid. (Refer to IEEE488.2, 7.7.7.2) For example, the brackets are not paired or the character is violating the standard.

-178

**Expression data not allowed**

On the position where E4991A would not receive expression data element, the expression data element has been found.

-200

**Execution error**

There was an execution error in which the E4991A could not specify the error message. This code shows that execution error defined in IEEE488.2, 11.5.1.1.5 has occurred.

-211

**Trigger ignored**

## Messages

### Error number: -213

Trigger command ("\*TRG"), or external trigger signal has been received and detected by E4991A but because of the timing with the E4991A (For example, the E4991A trigger was not in waiting condition), it was ignored. When the trigger becomes the waiting condition, set to prepare for trigger command or external trigger signal to be sent.

-213

#### **Init ignored**

Due to the fact that other measurement was already underway, the Measurement Initialize Request ("INIT" command) was ignored. For example, change the setting of "INIT:CONT" to "OFF" and "TRIG:SOUR" command to "BUS" and trigger with "\*TRG" command. Until the sweep is completed a weight will be pressured when sending "INIT" command, it will be regarded as E4991A.

-221

#### **Settings conflict**

Even though the program data element has been received and it conforms to the standard, with the present condition of E4991A, the present day condition, execution is not possible.

-222

#### **Data out of range**

Data element well out of range (not violating the standard) from the E4991A defined range has been received.

-223

#### **Too much data**

Even though the program data received in block, expression, or series of characters conformed to the standard, due to the fixed condition of memory or memory related devices, the capacity is over what E4991A can hold.

-224

#### **Illegal parameter value**

Parameter rate is not appropriate. For example, when a message; "DISP:TRAC1:Y:SPAC OBAS" has been sent toward the correct program message; "DISP:TRAC1:Y:SPAC LOG", the parameter rate will be regarded by E4991A as inappropriate. Refer to the command reference and check to see if the parameter rates is correctly inputted.

-230

#### **Data corrupt or stale**

Data may have the possibility to be invalid. Also, the newly started reading procedure has not been completed since its latest updated access.

-256

#### **File name not found**

Designated file could not be found and the command was not correctly executed. For example, when attempts have been made to read and write on a file that does not exist, or when a disk is not inserted (properly), this error would occur.

-261

#### **Math error in expression**

A syntactically legal expression program data element could not be executed due to a math error such as a divide-by zero was attempted.

-272

#### **Macro execution error**

The E4991A macro-related execution error occurred.

- 310        **System error**  
On E4991A, either of the following so called "System Error" has occurred.
- 321        **Out of memory**  
Memory (RAM) is in shortage.
- 400        **Query error**  
E4991A has found Query error which is not able to specify the error message. This code shows that Query error defined in IEEE488.2, 11.5.1.1.7 or 6.3 has occurred.
- 410        **Query INTERRUPTED**  
This is a condition to create "INTERRUPTED" Query error. (Refer to IEEE488.1, 6.3.2.3)  
This error is generated when, for example, after the Query and while its response may not be fully sent, data byte "DAB" or Get have been received.
- 420        **Query UNTERMINATED**  
This is a condition to create "UNTERMINATED" Query error. (Refer to IEEE488.1, 6.3.3.2). This error occurs when the E4991A is designated as a talker (if designated as a controller, data transmission is possible via interface) and receive incomplete program message to E4991A. For example, when a command without the Query such as "\*CLS" has been sent by sending "\*CLS?" command, it will be regarded as incomplete message by E4991A. Refer to the command reference for checking.
- 430        **Query DEADLOCKED**  
This is a condition to create "DEADLOCK" Query error. (Refer to IEEE488.2, 6.3.1.7)  
This error occurs for example, when both buffers on input and output becomes full and when the E4991A is no longer able to carry out the process.
- 440        **Query UNTERMINATED after indefinite response**  
Within the same program message, after the Query execution requiring indefinite response and also the Query has been received. (Refer to IEEE488.2, 6.5.7.5.7)

## Messages indicating the internal status of the equipment

Messages that indicate the internal status of the equipment include messages indicating irregularities of the equipment as well as those indicating the results of processing (elapsing). These messages do not have numbers.

### Messages indicating the measurement failure

#### DC bias overload

During DC bias voltage application, there was a sudden change on the connecting condition of DUT, the direct-current impedance has lowered, resulting in momentary over-current on the DC bias source.

Do not remove DUT during the DC bias application. When this error occurs frequently during normal measurement, there may be a possible failure on the instrument. When that is the case, please contact your nearest Agilent Technologies branch office or company where you have purchased the instrument.

#### PLL Unlock

Error has been detected in the internal PLL (Phase Lock Loop) circuit of the E4991A. PLL is used to generate a stable frequency source. It could occur with error on the external reference signal, or when turning the power ON in the lower temperature.

If the external reference signal is not inputted or have no error, instrument tuning or repair is necessary. If the message does not disappear in a few minutes after turning the power ON, instrument tuning or repair is necessary. Please contact your nearest Agilent Technologies branch office or company where you have purchased the instrument.

#### Power on test failed

Error was detected during self-test after loading the power.

Please contact your nearest Agilent Technologies branch office or company where you have purchased the instrument.

#### RF overload

Due to the sudden change of impedance caused by removal of DUT or other reasons during the measurement, there was a failure of ranging in the internal circuit.

Do not remove DUT during the measurement. When this error occurs frequently during normal measurement, there may be a possible failure on the instrument. When that is the case, please contact your nearest Agilent Technologies branch office or company where you have purchased the instrument.

## **Messages indicating the results of processing (elapsing)**

### **Cal done**

Calculation and storing of a calibration coefficient completed.

### **Cal measure aborted**

Measurement of calibration data aborted.

### **Comp done**

Calculation and storing of a fixture compensation coefficient completed.

### **Comp measure aborted**

Measurement of a fixture compensation coefficient aborted.

### **Peak not found**

Peak search function executed, but defined peak not found.

### **Target value not found**

Target search function executed, but target measurement value not found.

### **Trigger hold**

Measurement is in hold mode (mode that does not accept trigger).

### **Wait -- measuring cal standard**

-- Calibration data being measured.

### **Wait -- measuring comp standard**

-- Fixture compensation data being measured.

Messages  
Error number:



**Symbols**

\*.bas, 221  
 \*.bmp, 177  
 \*.dat, 177, 178  
 \*.frm, 221  
 \*.jpg, 177  
 \*.lcr, 177, 178, 221  
 \*.sta, 177, 178  
 \*.txt, 177

**A**

ASCII format, 120  
 auto scale, 51  
 Autorec.sta, 178  
 Autost.lcr, 230  
 averaging  
   point averaging factor  
     under linear/log sweep, 50  
     under segment sweep, 65  
 sweep averaging  
   averaging factor, 50  
   on/off, 50  
   reset, 50  
 turns on/off point averaging  
   under linear/log sweep, 50

**B**

backlight, 198  
 basic measurement programs, 254  
 beep sounds, 516  
 binary format  
   byte order, 122  
 block  
   Font rules in this manual, 3  
 bold  
   Font rules in this manual, 2  
 box  
   Font rules in this manual, 3  
 button  
   Font rules in this manual, 3

**C**

calibration  
   calibration coefficient array, 126  
   calibration data array, 125  
   clears calibration data/coefficient array, 77  
   detects measurement end  
     using COM interface, 537  
     using GPIB command, 76  
   detects measurement start  
     using COM interface, 538  
   disables calibration, 76  
   measurement done (enables calibration), 76  
   measurement points, 75  
   measures calibration data  
     using COM interface, 533

    using GPIB command, 76  
   reads calibration data array, 77  
   sets/reads calibration coefficient array, 77  
 calibration kit  
   defines standard values using list setting function, 74  
   defines standard values without using list setting function,  
     74  
   selection, 74  
   turns on/off list setting function, 74

**CITIfile**

  save, 177

**COM**

  #, 544  
   \*, 544  
   copies screen image to clipboard, 535  
   copies text data to clipboard, 535  
   event for DC bias overload error, 539  
   event for PLL Unlock error, 539  
   event for RF overload error, 540  
   event for specified sweep end, 537  
   event for specified sweep start, 538  
   event for sweep averaging completion, 538  
   executes sweep, 532  
   GPIB command vs. COM, 239  
   how to read the comma separated data (array data), 547  
   measures calibration data, 533  
   measures fixture compensation data, 534  
   reads the returned value of the GPIB command, 542  
   receives GPIB query response, 543  
   sends GPIB command using COM, 239, 543  
   sets wait time for event, 536

**COM Interface**

  CalMeasure method, 533  
   CompenMeasure method, 534  
   CompleteSweepAveraging event, 538  
   Connection property, 531  
   DcBiasOverload event, 539  
   Enter method, 542  
   GetScreenImage method, 535  
   GetTextData method, 535  
   Name property, 530, 541  
   Output method, 543  
   Query method, 543  
   RfOverload event, 540  
   SingleMeasure method, 532  
   SweepEnd event, 537  
   SweepStart event, 538  
   Unlocked event, 539  
   VBVersion property, 530  
   WaitForEvent method, 536  
 complex operation program, 600  
 complex trace, 40  
 CW frequency, 48

**D**

  data array, 124  
   data file

- recall, 178
- save, 177
- data trace array, 124
- date
  - setting, 517
- DC bias
  - application program for DC power supply, 248
  - application program for DC power supply(external instrument), 251
- dc bias
  - current limit maximum value, 49
  - DC bias current/voltage limitation error, 604
  - DC bias overload error, 604
  - in case of segment sweep
    - current limit maximum value, 65
    - output current level, 65
    - output voltage level, 65
    - voltage limit maximum value, 65
  - monitor function
    - dc bias level monitor array, 124
    - on/off, 49
  - output current level, 49
  - output voltage level, 49
  - turns current output on/off, 49, 65
  - turns voltage output on/off, 49, 65
  - voltage limit maximum value, 49
- dc bias current sweep
  - selects dc bias current sweep, 44
  - sweep range, 46
  - turns output on/off, 46
  - voltage limit maximum value, 46
- dc bias voltage sweep
  - current limit maximum value, 46
  - selects dc bias voltage sweep, 44
  - sweep range, 46
  - turns output on/off, 46
- delay time, 47
- dielectric material measurement
  - calibration
    - definition of load standard, 75
    - selects load standard, 75
  - selection of measurement mode, 40
  - thickness of DUT, 40
- display
  - backlight, 198
  - enable/disable display update, 198
  - measurement screen, 198
  - split/overlay, 198
  - timing of refresh, 200
- display format
  - in case of complex trace, 43
  - in case of scalar trace, 42
- E**
- E4991A library
  - object browser, 228
  - where to install, 244
- equivalent circuit analysis
  - equivalent circuit model, 167
  - performs equivalent circuit analysis, 168
  - simulates frequency characteristics, 168
- error message
  - error queue, 202
  - list, 605
- event, 238
- external controller, 27
- external instruments
  - controlling external instruments from E4991A, 245
- external reference signal
  - input, 518
- F**
- file
  - catalog, 176
  - copying, 179
  - deleting, 179
  - renaming, 179
- fixed frequency / fixed power points calibration, 75
- fixed frequency / fixed power points compensation, 94
- fixed frequency / user defined power points compensation, 94
- fixed frequency / user-defined power points calibration, 75
- fixture compensation
  - detects measurement end
    - using COM interface, 537
    - using GPIB command, 95
  - detects measurement start
    - using COM interface, 538
  - fixture compensation coefficient array, 128
  - fixture compensation data array, 127
  - measurement done (enable function), 95
  - measures fixture compensation data
    - using COM interface, 534
    - using GPIB command, 95
  - reads fixture compensation data array, 96
  - selects measurement points, 94
  - sets/reads fixture compensation coefficient array, 96
- fixture compensation kit
  - defines standard values using list setting function, 93
  - defines standard values without using list setting function, 93
  - turns on/off list setting function, 93
- folder
  - creating, 179
  - current folder, 176
  - deleting, 179
- Font
  - Font rules in this manual, 2
- frequency sweep
  - selects frequency sweep, 44
  - sweep range
    - under linear/log sweep, 45
- front panel
  - lock, 31

**G****GPIB**

- controller mode, 33
- system controller
  - pass control, 28
  - what is GPIB, 26

**GPIB command**

- \*CLS, 279
- \*ESE, 280
- \*ESR?, 280
- \*IDN?, 281
- \*OPC, 281
- \*OPC?, 281
- \*OPT?, 282
- \*RST, 282
- \*SRE, 283
- \*STB?, 283
- \*TRG, 284
- \*TST?, 284
- \*WAI, 284

- [SENSe:]AVERAge:COUNT, 288
- [SENSe:]AVERAge[:STATe], 287
- [SENSe:]FREQUency:CENTer, 376
- [SENSe:]FREQUency:SPAN, 377
- [SENSe:]FREQUency:SPAN:FULL, 377
- [SENSe:]FREQUency:START, 378
- [SENSe:]FREQUency:STOP, 379
- [SENSe:]FREQUency[:CW]:FIXed], 375
- [SENSe:]SEGMENT:CURRENT:OFFSet:STATe, 399
- [SENSe:]SEGMENT:CURRENT:STATe, 402
- [SENSe:]SEGMENT:DATA:ALL, 405
- [SENSe:]SEGMENT:DELETE:ALL, 406
- [SENSe:]SEGMENT:POWER:STATe, 412
- [SENSe:]SEGMENT:VOLTage:OFFSet:STATe, 417
- [SENSe:]SEGMENT:VOLTage:STATe, 418
- [SENSe:]SEGMENT{1-16}:AVERAge:COUNT, 396
- [SENSe:]SEGMENT{1-16}:CURRENT:LIMit, 400
- [SENSe:]SEGMENT{1-16}:CURRENT:OFFSet, 401
- [SENSe:]SEGMENT{1-16}:CURRENT[:LEVel], 398
- [SENSe:]SEGMENT{1-16}:DATA, 403
- [SENSe:]SEGMENT{1-16}:FREQUency:CENTer, 407
- [SENSe:]SEGMENT{1-16}:FREQUency:SPAN, 408
- [SENSe:]SEGMENT{1-16}:FREQUency:START, 409
- [SENSe:]SEGMENT{1-16}:FREQUency:STOP, 410
- [SENSe:]SEGMENT{1-16}:POWER[:LEVel], 411
- [SENSe:]SEGMENT{1-16}:SWEep:POINTs, 413
- [SENSe:]SEGMENT{1-16}:VOLTage:LIMit, 415
- [SENSe:]SEGMENT{1-16}:VOLTage:OFFSet, 416
- [SENSe:]SEGMENT{1-16}:VOLTage[:LEVel], 414
- [SENSe:]SWEep:DIRection, 508
- [SENSe:]SWEep:DWELl1, 508
- [SENSe:]SWEep:DWELl2, 509
- [SENSe:]SWEep:DWELl3, 510
- [SENSe:]SWEep:POINTs, 511
- [SENSe:]SWEep:STIMulus{1-4}?, 512
- [SENSe:]SWEep:TIME, 513
- [SENSe:]SWEep:TIME:AUTO, 514

- [SENSe:]SWEep:TYPE, 515
- [SENSe:]SEGMENT:COUNT, 397
- [SENSe:]MODE, 393
- 4291B commands vs. E4991A commands, 580
- ABORT, 286
- CALC{1-5}:MARKer:FUNCTION:DOMain:LIMit ALL[:STATe], 314
- CALC{1-5}:MARKer:FUNCTION:DOMain:SPAN, 319
- CALC{1-5}:MARKer:FUNCTION:DOMain:START, 320
- CALC{1-5}:MARKer:FUNCTION:DOMain:STOP, 320
- CALC{1-5}:MARKer:FUNCTION:EXECute:LEFT, 322
- CALC{1-5}:MARKer:FUNCTION:EXECute:NEXT, 322
- CALC{1-5}:MARKer:FUNCTION:EXECute:RIGHT, 323
- CALC{1-5}:MARKer:SET, 336
- CALC{1-5}:MARKer{1-8}:FUNCTION:DOMain:LIMit:LOWER, 316
- CALC{1-5}:MARKer{1-8}:FUNCTION:DOMain:LIMit:UPPER, 318
- CALC{1-5}:MARKer{1-8}:FUNCTION:DOMain:LIMit[:STATe], 313
- CALCulate:AVERAge:CLEar, 289
- CALCulate:AVERAge:COUNT, 290
- CALCulate:AVERAge[:STATe], 289
- CALCulate:DATA:MONitor?, 292
- CALCulate:FORMat:PARAMeter:DIElectric, 300
- CALCulate:FORMat:PARAMeter:MAGnetic, 302
- CALCulate[:EVALuate]:BMONitor[:STATe], 291
- CALCulate{1-3}:MATH:OFFSet, 342
- CALCulate{1-5}:DATA:EPARAMeter, 294
- CALCulate{1-5}:DATA?, 293
- CALCulate{1-5}:EPARAMeters, 295
- CALCulate{1-5}:EPARAMeters:CIRCUit[:TYPE], 296
- CALCulate{1-5}:EPARAMeters:SIMulation, 297
- CALCulate{1-5}:FORMat, 298
- CALCulate{1-5}:FORMat:PARAMeter:EPHase, 301
- CALCulate{1-5}:FORMat:UNIT:ANGLE, 303
- CALCulate{1-5}:MARKer:AOff, 305
- CALCulate{1-5}:MARKer:APeak:SET, 306
- CALCulate{1-5}:MARKer:COUPle, 309
- CALCulate{1-5}:MARKer:FUNCTION:DOMain:LIMit:ALL:RESult?, 315
- CALCulate{1-5}:MARKer:LIST, 326
- CALCulate{1-5}:MARKer:ON, 327
- CALCulate{1-5}:MARKer:REFERENCE:ACTivate, 329
- CALCulate{1-5}:MARKer:REFERENCE:FUNCTION:DOMain:LIMit:RESult?, 331
- CALCulate{1-5}:MARKer:REFERENCE:FUNCTION:DOMain:LIMit:UPPER, 330, 332
- CALCulate{1-5}:MARKer:REFERENCE:FUNCTION:DOMain:LIMit[:STATe], 329
- CALCulate{1-5}:MARKer:REFERENCE:X, 334
- CALCulate{1-5}:MARKer:REFERENCE:Y, 335
- CALCulate{1-5}:MARKer:UNIT, 337
- CALCulate{1-5}:MARKer{1-8}:ACTivate, 305
- CALCulate{1-5}:MARKer{1-8}:APeak:EXCURsion:X, 307

- CALCulate{1-5}:MARKer{1-8}:APEak:EXCursion:Y, 308
- CALCulate{1-5}:MARKer{1-8}:DIScrete, 309
- CALCulate{1-5}:MARKer{1-8}:FORMat, 310
- CALCulate{1-5}:MARKer{1-8}:FUNction:DOMain:LIMit:RESult?, 317
- CALCulate{1-5}:MARKer{1-8}:FUNction:DOMain[:STATe], 312
- CALCulate{1-5}:MARKer{1-8}:FUNction:EXECute, 321
- CALCulate{1-5}:MARKer{1-8}:FUNction:TARGet, 324
- CALCulate{1-5}:MARKer{1-8}:FUNction:TRACking, 325
- CALCulate{1-5}:MARKer{1-8}:FUNction[:SELect], 311
- CALCulate{1-5}:MARKer{1-8}:X, 338
- CALCulate{1-5}:MARKer{1-8}:Y?, 339
- CALCulate{1-5}:MARKer{1-8}[:STATe], 304
- CALCulate{1-5}:MARKerREFerence:TYPE, 333
- CALCulate{1-5}:MARKerREFerence[:STATe], 328
- CALCulate{1-5}:MATH:FUNction, 340
- CALCulate{1-5}:MATH:MEMorize, 341
- CALCulate{1-5}[:EVALuate]:MSTatistics:DATA?, 344
- CALCulate{1-5}[:EVALuate]:MSTatistics[:STATe], 343
- command reference
  - indicate rule, 238
- DATA[:DATA]:CAD{1-8}?, 345
- DATA[:DATA]:CCO{1-6}, 346
- DATA[:DATA]:CMD{1-2}?, 347
- DATA[:DATA]:CMP{1-3}, 348
- DATA[:DATA]:RAW?, 349
- DATA[:DATA]:SEGment{1-16}:CAD{1-8}?, 350
- DATA[:DATA]:SEGment{1-16}:CCO{1-6}, 351
- DATA[:DATA]:SEGment{1-16}:CMD{1-2}?, 352
- DATA[:DATA]:SEGment{1-16}:CMP{1-3}?, 353
- DISPlay:BACKlight, 354
- DISPlay:ENABLE, 354
- DISPlay[:WINDow]:FORMat, 355
- DISPlay[:WINDow]:TEXT[:STATe], 355
- DISPlay[:WINDow]:TEXT{1-3}:SET, 356
- DISPlay[:WINDow]:TRACe:Y[:SCALE]:AUTO:ALL, 364
- DISPlay[:WINDow]:TRACe{1-3}:REFerence[:STATe], 358
- DISPlay[:WINDow]:TRACe{1-3}:Y:SPACing, 371
- DISPlay[:WINDow]:TRACe{1-3}:Y[:SCALE]:BOTTom, 365
- DISPlay[:WINDow]:TRACe{1-3}:Y[:SCALE]:RPOsition1, 370
- DISPlay[:WINDow]:TRACe{1-3}:Y[:SCALE]:TOP, 372
- DISPlay[:WINDow]:TRACe{1-5}:GRATicule:FORMat, 357
- DISPlay[:WINDow]:TRACe{1-5}:SELect, 358
- DISPlay[:WINDow]:TRACe{1-5}:TEXT:PAGE, 359
- DISPlay[:WINDow]:TRACe{1-5}:TEXT[:STATe], 359
- DISPlay[:WINDow]:TRACe{1-5}:TITLe:DATA, 361
- DISPlay[:WINDow]:TRACe{1-5}:TITLe[:STATe], 360
- DISPlay[:WINDow]:TRACe{1-5}:X:SPACing, 363
- DISPlay[:WINDow]:TRACe{1-5}:Y:AUTO, 364
- DISPlay[:WINDow]:TRACe{1-5}:Y[:SCALE]:FOR, 366
- DISPlay[:WINDow]:TRACe{1-5}:Y[:SCALE]:FULL, 367
- DISPlay[:WINDow]:TRACe{1-5}:Y[:SCALE]:PDIVision, 368
- DISPlay[:WINDow]:TRACe{1-5}:Y[:SCALE]:RLEVel, 369
- DISPlay[:WINDow]:TRACe{1-5}[:STATe], 356
- DISPlay[:WINDow]:TRACe{4-5}:X[:SCALE]:RLEVel, 362
- E4991A commands, 29
- FORMat:BORDER, 373
- FORMat:DATA, 374
- HCOPY:ABORT, 380
- HCOPY:CONtent, 380
- HCOPY:IMAGe, 381
- HCOPY[:IMMediate], 380
- IEEE common commands, 29
- INITiate:CONTinuous, 382
- INITiate[:IMMediate], 382
- list by function, 566
- MMEMory:CATalog?, 383
- MMEMory:CDIRectory, 383
- MMEMory:COPI, 384
- MMEMory:DELeTe, 384
- MMEMory:LOAD:MACRo, 385
- MMEMory:LOAD:TRACe, 386
- MMEMory:LOAD[:STATe], 385
- MMEMory:MDIRectory, 386
- MMEMory:MOVE, 387
- MMEMory:RDIRectory, 388
- MMEMory:STORe:CITI{1-3}, 389
- MMEMory:STORe:GRAPh:BMP, 390
- MMEMory:STORe:GRAPh[:JPG], 389
- MMEMory:STORe:MACRo, 390
- MMEMory:STORe:TRAC[:BINary], 391
- MMEMory:STORe:TRACe:ASCii, 391
- MMEMory:STORe:TRACe:SELect{1-4}, 392
- MMEMory:STORe[:STATe], 388
- PROGram:CATalog?, 394
- PROGram[:SELecteD]:NAME, 394
- PROGram[:SELecteD]:STATe, 395
- PROGram[:SELecteD]:WAIT, 395
- SENSe:CORRection1:CKIT, 420
- LIST[:STATe], 421
- SENSe:CORRection1:CKIT:STANdard1:C, 422
- SENSe:CORRection1:CKIT:STANdard1:G, 423
- SENSe:CORRection1:CKIT:STANdard1:LIST:B, 424
- SENSe:CORRection1:CKIT:STANdard1:LIST:G, 425
- SENSe:CORRection1:CKIT:STANdard2:L, 426
- SENSe:CORRection1:CKIT:STANdard2:LIST:R, 427
- SENSe:CORRection1:CKIT:STANdard2:LIST:X, 428
- SENSe:CORRection1:CKIT:STANdard2:R, 429
- SENSe:CORRection1:CKIT:STANdard3:L, 430
- SENSe:CORRection1:CKIT:STANdard3:LIST:R, 431, 443
- SENSe:CORRection1:CKIT:STANdard3:LIST:X, 432
- SENSe:CORRection1:CKIT:STANdard3:R, 433

SENSE:CORRection1:CKIT:STANdard7:PLFactor, 434  
 SENSE:CORRection1:CKIT:STANdard7:PREal, 435  
 SENSE:CORRection1:CKIT:STANdard7:THICKness, 436  
 SENSE:CORRection1:COLLect:FPOints, 438  
 SENSE:CORRection1:COLLect:SAVE, 439  
 SENSE:CORRection1:COLLect[:ACQuire], 437  
 SENSE:CORRection1[:STATe], 419  
 SENSE:CORRection2:CKIT:LIST[:STATe], 440  
 SENSE:CORRection2:CKIT:STANdard1:C, 441  
 SENSE:CORRection2:CKIT:STANdard1:G, 442  
 SENSE:CORRection2:CKIT:STANdard1:LIST:G, 444  
 SENSE:CORRection2:CKIT:STANdard2:L, 445  
 SENSE:CORRection2:CKIT:STANdard2:LIST:R, 446  
 SENSE:CORRection2:CKIT:STANdard2:LIST:X, 447  
 SENSE:CORRection2:CKIT:STANdard2:R, 448  
 SENSE:CORRection2:COLLect:FPOints, 450  
 SENSE:CORRection2:COLLect:OPEN[:STATe], 451  
 SENSE:CORRection2:COLLect:SAVE, 451  
 SENSE:CORRection2:COLLect:SHORT[:STATe], 452  
 SENSE:CORRection2:COLLect[:ACQuire], 449  
 SENSE:CORRection2:EDELay:TIME, 453  
 SENSE:CORRection2:FIXTure:EDELay, 454  
 SENSE:CORRection2:FIXTure:EDELay:MODEl:DISTanC  
 e?, 455  
 SENSE:CORRection2:FIXTure:EDELay:USER:DISTanC  
 e, 456  
 SOURce:CURRent:CENTer, 458  
 SOURce:CURRent:LIMit:OFFSet, 459  
 SOURce:CURRent:MODE, 460  
 SOURce:CURRent:SPAN, 467  
 SOURce:CURRent:STARt, 468  
 SOURce:CURRent:STOP, 469  
 SOURce:CURRent[:LEVel][:IMMediate][:AMPLitude],  
 457  
 SOURce:CURRent[:LEVel][:IMMediate][:AMPLitude]:O  
 FFSet, 461  
 SOURce:CURRent[:LEVel][:IMMediate][:AMPLitude]:O  
 FFSet:CENTer, 462  
 SOURce:CURRent[:LEVel][:IMMediate][:AMPLitude]:O  
 FFSet:SPAN, 463  
 SOURce:CURRent[:LEVel][:IMMediate][:AMPLitude]:O  
 FFSet:STARt, 464  
 SOURce:CURRent[:LEVel][:IMMediate][:AMPLitude]:O  
 FFSet:STATe, 465  
 SOURce:CURRent[:LEVel][:IMMediate][:AMPLitude]:O  
 FFSet:STOP, 466  
 SOURce:POWer:CENTer, 471  
 SOURce:POWer:MODE, 472  
 SOURce:POWer:SPAN, 473  
 SOURce:POWer:STARt, 474  
 SOURce:POWer:STOP, 475  
 SOURce:POWer[:LEVel][:IMMediate][:AMPLitude], 470  
 SOURce:VOLTagE:CENTer, 477  
 SOURce:VOLTagE:LIMit:OFFSet, 478  
 SOURce:VOLTagE:MODE, 479  
 SOURce:VOLTagE:SPAN, 486  
 SOURce:VOLTagE:STARt, 487  
 SOURce:VOLTagE:STOP, 488  
 SOURce:VOLTagE[:LEVel][:IMMediate][:AMPLitude],  
 476  
 SOURce:VOLTagE[:LEVel][:IMMediate][:AMPLitude]:O  
 FFSet, 480  
 SOURce:VOLTagE[:LEVel][:IMMediate][:AMPLitude]:O  
 FFSet:CENTer, 481  
 SOURce:VOLTagE[:LEVel][:IMMediate][:AMPLitude]:O  
 FFSet:SPAN, 482  
 SOURce:VOLTagE[:LEVel][:IMMediate][:AMPLitude]:O  
 FFSet:STARt, 483  
 SOURce:VOLTagE[:LEVel][:IMMediate][:AMPLitude]:O  
 FFSet:STATe, 484  
 SOURce:VOLTagE[:LEVel][:IMMediate][:AMPLitude]:O  
 FFSet:STOP, 485  
 STATus:OPERation:CONDition?, 489  
 STATus:OPERation:ENABle, 490  
 STATus:OPERation:NTRansition, 491  
 STATus:OPERation:PTRansition, 492  
 STATus:OPERation[:EVENT]?, 489  
 STATus:PRESet, 493  
 STATus:QUESTionable:CONDition?, 493  
 STATus:QUESTionable:ENABle, 494  
 STATus:QUESTionable:HARDWare:CONDition?, 495, 496  
 STATus:QUESTionable:HARDWare:NTRansition, 497  
 STATus:QUESTionable:HARDWare:PTRansition, 498  
 STATus:QUESTionable:HARDWare[:EVENT]?, 495  
 STATus:QUESTionable:LIMit:CONDition?, 499  
 STATus:QUESTionable:LIMit:ENABle, 500, 505  
 STATus:QUESTionable:LIMit:NTRansition, 501  
 STATus:QUESTionable:LIMit:PTRansition, 502  
 STATus:QUESTionable:LIMit[:EVENT]?, 499  
 STATus:QUESTionable:NTRansition, 503  
 STATus:QUESTionable:PTRansition, 504  
 STATus:QUESTionable:SEARch:NTRansition, 506  
 STATus:QUESTionable:SEARch:PTRansition, 507  
 STATus:QUESTionable[:EVENT]?, 493  
 STATus:QUESTionableSEARch:CONDition?, 505  
 STATus:QUESTionableSEARch[:EVENT]?, 504  
 SYSTem:BEEPer:STATe, 516  
 SYSTem:BEEPer[:IMMediate], 516  
 SYSTem:DATE, 517  
 SYSTem:ERRor:COUNT?, 518  
 SYSTem:ERRor?, 517  
 SYSTem:EXTRef?, 518  
 SYSTem:INdEx:POINt:SET, 519  
 SYSTem:INdEx:SWEEp:SET, 519  
 SYSTem:INdEx:TIME, 520  
 SYSTem:INdEx:TIME:SET, 521  
 SYSTem:KLOCK:KBD, 522  
 SYSTem:KLOCK:MOUSE, 523  
 SYSTem:KLOCK[:FPANel], 522  
 SYSTem:POFF, 523  
 SYSTem:PRESet, 523  
 SYSTem:TIME, 524  
 SYSTem:VERSIon?, 524  
 TRIGger[:SEQuence]:EVENT[:TYPE], 525

- TRIGger[:SEquence]:SLOPe, 526
- TRIGger[:SEquence]:SOURce, 526
- TRIGger[:SEquence][:IMMEDIATE], 525
- graph file
  - save, 177
- H**
- history,
  - manual printing, 2
- I**
- I/O library
  - controlling peripherals from E4991A, 245
- IEEE 32 bit floating point format, 121
- IEEE 64 bit floating point format, 122
- input device
  - lock, 31
- Installation and Quick Start Guide, 4
- internal data array
  - save
    - selection, 177
- Italic
  - Font rules in this manual, 2
- K**
- key
  - Font rules in this manual, 2
- keyboard
  - lock, 31
- L**
- LAN, 35
- limit test function, 147
  - displays test condition and results, 148
  - on/off, 147
  - reads test results, 148
  - sets test limit, 147
  - sets test marker, 147
  - using questionable status limit event register, 148
- load standard
  - defines standard values, 74
  - measures calibration data
    - using COM interface, 533
    - using GPIB command, 76
- low-loss capacitor
  - measures calibration data
    - using COM interface, 533
    - using GPIB command, 76
- M**
- macros
  - abruptly terminating macros, 231
  - automatically executing macros, 230
  - debugging, 229
  - executing macros, 230
  - execution error, 229
- GPIB
  - controller mode, 33
  - loading macros, 233
  - logic error, 229
  - macro recording, 228
  - recalling macros, 178
  - returns to measurement screen, 214
  - saving macros, 177, 232
  - stopping macros, 231
  - syntax error, 229
  - VBA help, 220
  - Visual Basic editor
    - startup/close, 214
- magnetic material measurement
  - selection of measurement mode, 40
  - sizes of DUT, 40
- Manual
  - About the Manual Regarding this Device, 4
  - manual changes, 549
  - manual printing history, 2
- marker
  - continuous/discontinuous marker mode, 141
  - coupled mode, 141
  - delta mode
    - fixed delta mode, 142
    - selects mode, 142
  - displays marker list, 141
  - marker search
    - definition of peak search, 145
    - definition of target search, 145
    - execution, 146
    - partial search function, 144
    - questionable status search event register, 553
    - reads results using status report system, 146
    - selects search point, 144
    - tracking function, 146
  - measurement value
    - reads value, 142
    - selects format, 142
  - on/off, 140
  - selects data/memory trace, 141
  - sets active marker, 140
  - sets E4991A setting using marker value, 143
  - static analysis function, 149
  - stimulus value
    - selects unit, 141
    - sets/reads value, 141
- measurement failure
  - DC bias current/voltage limitation error, 604
  - DC bias overload error, 604
  - overload error, 604
  - PLL unlock error, 604
  - questionable status hardware event register, 553
- measurement mode
  - selection, 40
- measurement of inductors self-resonance point, 254



measurement parameters  
 in case of complex trace, 43  
 in case of scalar trace, 41  
 memory array, 124  
 memory trace, 199  
 memory trace array, 124  
 menu  
 Font rules in this manual, 3  
 message, 605  
 method, 238  
 mouse  
 lock, 31

**N**

number of measurement points  
 under linear/log sweep, 44  
 under segment sweep, 65

**O**

offset  
 set offset (scalar trace), 199  
 offset delay time, 92  
 open compensation  
 turns on/off open compensation, 95  
 open standard  
 defines standard values, 74, 93  
 measures calibration data  
 using COM interface, 533  
 using GPIB command, 76  
 measures fixture compensation data  
 using COM interface, 534  
 using GPIB command, 95  
 operation status event register, 553  
 Operational Manual, 4  
 OSC level sweep  
 selects OSC level sweep, 44  
 sweep range, 45  
 overload, 604

**P**

peripherals  
 controlling peripherals from E4991A, 245  
 phase display  
 sets unit, 42  
 turns on/off expand phase display, 42  
 PLL unlock, 604  
 port extension  
 offset delay time, 92  
 print  
 cancel, 196  
 color, 196  
 contents, 196  
 printout, 196  
 Programming Manual, 4  
 property, 238

**Q**

questionable status event register, 553  
 questionable status hardware event register, 553  
 questionable status limit event register, 553  
 questionable status search event register, 553  
 Quick Start Guide, 4

**R**

raw data array, 123  
 remote mode, 31, 34, 37  
 remote user interface function, 35

**S**

sample program  
 ext\_cont.bas, 251  
 visa32.bas, 246  
 vpptype.bas, 246  
 sample programs  
 asc\_read.bas, 131  
 asc\_read.htb, 129  
 bias\_mon.bas, 136  
 bias\_mon.htb, 133  
 bsc\_meas.bas, 267  
 bsc\_meas.cls, 206, 272  
 bsc\_meas.htb, 257  
 cal\_inp.bas, 89  
 cal\_inp.htb, 87  
 cal\_meas.bas, 83  
 cal\_meas.htb, 78  
 circuit.bas, 172  
 circuit.htb, 169  
 com\_meas.bas, 102  
 com\_meas.htb, 97  
 error.bas, 206  
 error.htb, 204  
 event when the measurement failure occurs in the analyzer,  
 272  
 example program for calibration coefficient transfer, 87, 89  
 example program for equivalent circuit analysis, 169, 172  
 example program for error handling, 204, 206  
 example program for execution of calibration, 78, 83  
 example program for execution of fixture compensation, 97,  
 102  
 example program for marker limit test function, 159, 163  
 example program for marker search function, 150, 154  
 example program for reading the data trace array (ASCII  
 format), 129, 131  
 example program for reading the dc bias level monitor  
 array, 133, 136  
 example program for saving/recalling a file, 180, 187  
 example program for setting the measuring conditions, 55,  
 59  
 example program for setting the segment sweep conditions,  
 66, 70  
 example program for the detection of a measurement end,  
 114, 116

- lim\_test.bas, 163
  - lim\_test.htb, 159
  - measuring the self-resonant point of an inductor, 257, 267
  - mkr\_sear.bas, 154
  - mkr\_sear.htb, 150
  - save\_rec.bas, 187
  - save\_rec.htb, 180
  - segm\_set.bas, 70
  - segm\_set.htb, 66
  - setup.bas, 59
  - setup.htb, 55
  - sweep.bas, 116
  - swp\_sq.htb, 114
  - scalar trace, 40
  - scale
    - auto scale, 51
    - manual setting
      - complex plane format, 52
      - linear Y-axis format, 51
      - log Y-axis format, 52
      - polar format, 52
    - selects data/memory trace, 51
  - SCPI
    - reads SCPI version, 524
  - segment sweep
    - creates segments, 64
    - dc bias
      - current limit maximum value, 65
      - output current level, 65
      - output mode, 64
      - output voltage level, 65
      - voltage limit maximum value, 65
    - delay time, 47
    - deletes all segments, 64
    - displays the segment sweep table, 64
    - frequency range, 65
    - number of measurement points, 65
    - OSC level, 65
    - OSC level unit, 64
    - point averaging factor, 65
    - reads the total number of segments, 64
    - selects segment sweep, 44
    - set segment parameters collectively, 65
  - Serial number plate, 550
  - short compensation
    - turns on/off short compensation, 95
  - short standard
    - defines standard values, 74, 93
    - measures calibration data
      - using COM interface, 533
      - using GPIB command, 76
    - measures fixture compensation data
      - using COM interface, 534
      - using GPIB command, 95
  - shutdown, 209, 210
  - source
    - CW frequency, 48
    - OSC level
      - under linear/log sweep, 48
      - under segment sweep, 65
  - standard event status register, 553
  - state file
    - recall, 178
    - save, 177
  - static analysis function, 149
  - STEP, 248
  - stimulus array, 124
  - sweep
    - detects measurement end
      - using COM interface, 537
      - using GPIB command, 112
    - detects measurement start
      - using COM interface, 538
    - execution
      - using COM interface, 532
      - using GPIB command, 111
    - sweep direction, 44
    - sweep parameter, 44
    - sweep time
      - auto on/off, 47
      - sets time, 47
    - sweep type, 44
- ## T
- test fixture
    - agilent test fixture
      - reads electric length, 91
      - selection, 91
    - custom test fixture
      - selection, 91
      - sets electric length, 91
  - This Manual
    - Font Rules, 2
  - time
    - setting, 524
  - title, 199
  - tool bar
    - Font rules in this manual, 3
  - trace
    - displays title, 199
    - selects data/memory trace, 199
    - selects graph/text screen, 198
    - sets active trace, 198
    - sets offset, 199
    - sets trace, 40
  - trigger
    - continuous measurement, 111
    - measurement at any time, 111
    - trigger detection point, 109
    - trigger source, 109
    - trigger state, 108



---

**U**

- user defined frequency / user defined power points calibration, 75
- user defined frequency / user defined power points compensation, 94

**V**

- vbreadme.txt, 247
- VISA
  - application program for DC power supply(external instrument), 251
  - control flow with VISA, 247
  - importing definition files, 246
  - notes on using VISA library with VB, 247
  - online help of VISA library, 247
  - programming using VISA, 247
- visa.hlp, 247
- Visual Basic editor
  - close, 214
  - code window, 218
  - form designer, 218
  - module, 221
    - class module, 221
    - export, 223
    - import, 224
    - remove, 225
    - standard module, 221
    - user form, 221
  - object browser, 218
  - project, 221
  - project explorer, 216
  - property window, 216
  - startup, 214
  - toolbar, 215
  - toolbox, 218

**W**

- window
  - split/overlay, 198



## REGIONAL SALES AND SUPPORT OFFICES

*For more information about Agilent Technologies test and measurement products, applications, services, and for a current sales office listing, visit our web site: <http://www.agilent.com/find/tmdir>. You can also contact one of the following centers and ask for a test and measurement sales representative.* 11/29/99

### **United States:**

Agilent Technologies  
Test and Measurement Call Center  
P.O.Box 4026  
Englewood, CO 80155-4026  
(tel) 1 800 452 4844

(fax) (61 3) 9272 0749  
(tel) 0 800 738 378 (New Zealand)  
(fax) (64 4) 802 6881

### **Canada:**

Agilent Technologies Canada Inc.  
5150 Spectrum Way  
Mississauga, Ontario  
L4W 5G1  
(tel) 1 877 894 4414

### **Asia Pacific:**

Agilent Technologies  
24/F, Cityplaza One, 1111 King's Road,  
Taikoo Shing, Hong Kong  
(tel) (852)-3197-7777  
(fax) (852)-2506-9284

### **Europe:**

Agilent Technologies  
Test & Measurement  
European Marketing Organization  
P.O.Box 999  
1180 AZ Amstelveen  
The Netherlands  
(tel) (31 20) 547 9999

### **Japan:**

Agilent Technologies Japan Ltd.  
Call Center  
9-1, Takakura-Cho, Hachioji-Shi,  
Tokyo 192-8510, Japan  
(tel) (81) 426 56 7832  
(fax) (81) 426 56 7840

### **Latin America:**

Agilent Technologies  
Latin American Region Headquarters  
5200 Blue Lagoon Drive, Suite #950  
Miami, Florida 33126  
U.S.A.  
(tel) (305) 267 4245  
(fax) (305) 267 4286

### **Australia/New Zealand:**

Agilent Technologies Australia Pty Ltd  
347 Burwood Highway  
Forest Hill, Victoria 3131  
(tel) 1-800 629 485 (Australia)